

## Heritage Impact Assessment

Lakeview Golf Course

1190 Dixie Rd, Mississauga, ON L5E 2P4

May 02, 2024

Revised: May 09, 2024; May 14, 2024; June 17, 2024; June 18, 2024



Fairway of Hole 13, Lakeview Golf Course. Image from City of Mississauga video.

<https://www.mississauga.ca/golf/lakeview/>

## Table of Contents:

- 1.0 Introduction
  - 1.1 Property Information
- 2.1 Detailed Site History
  - 2.1.1 Formation of Lakeview Golf Course
  - 2.1.2 Early History of the Site
  - 2.1.3 Transformations after the first World War
  - 2.1.4 The Greenskeeper’s House
  - 2.1.5 Herbert Strong: Golf Course Architect
  - 2.1.6 Herbert Strong’s Contribution to the Design of Lakeview Golf Course
- 2.2 Existing Structures
  - 2.2.1 Description of the Existing Property
  - 2.2.2 Golf Course
  - 2.2.3 Greenskeeper’s Residence
  - 2.2.4 History of Alterations – The Greenskeeper’s House
  - 2.2.5 History of Site Development
  - 2.2.6 Fairways Condominium
  - 2.2.7 Applewood Creek Erosion Control Project
  - 2.2.8 Significance of Cultural Heritage Resources and their Attributes
  - 2.2.9 Designation as a Cultural Landscape
  - 2.2.10 Heritage Plaque
- 2.3 Existing Conditions
  - 2.3.1 Introduction
  - 2.3.2 Greenskeepers house
  - 2.3.3 Natural features
  - 2.3.4 Relevant Municipal or Agency Requirements
    - 2.3.4.1 City of Mississauga Plans and Policies
    - 2.3.4.2 Region of Peel Right-of Way
    - 2.3.4.3 Zoning
    - 2.3.4.4 Template Design and Standards for New Fire Stations
- 2.4 Proposed Development
  - 2.4.1 Background
  - 2.4.2 Fire Station Property Search
  - 2.4.3 Preferred Option for Development
- 2.5 Architectural Drawings
  - 2.5.1 Preferred Option Massing
  - 2.5.2 Preferred Option Mitigation
- 2.6 Assessment of Alternative Development Options and Mitigation Measures

- 2.6.1 Evaluation for Heritage Impact and Fire Station Functionality
- 2.6.2 Mitigation Option: Greenskeeper’s House Relocation
- 2.6.3 Other Site Locations Elsewhere in Mississauga
- 2.6.4 Mitigation Option 2
- 2.6.5 Mitigation Option 3
- 2.6.6 Recommendation
- 2.7 Summary of Conservation Principles
  - 2.7.1 Definitions
  - 2.7.2 Conservation Standards
- 2.8 Proposed Demolition/Alterations
  - 2.8.1 Impact Summary Chart
  - 2.8.2 Assessment of Preferred Option based on the Parks Canada Standards and Guidelines for the Conservation of Historic Places in Canada
- 2.9 Alternatives for Salvage Mitigation
- 3.0 Summary Statement and Conservation Recommendations
  - 3.1 Summary of the Significance and Heritage Attributes of the Cultural Heritage Resource
  - 3.2 Summary of the Impact of Proposed Development on the Cultural Heritage Resource
  - 3.3 Summary of recommended mitigative measures and approaches
- 4.0 Mandatory Recommendation
- 5.0 Qualifications

Appendix 1: Proposed Heritage Designation Lakeview Golf Course, 1190 Dixie Road (Ward 1), March 16, 2007

Appendix 2: Designation Statement for Lakeview Golf Course

Appendix 3: Topographic Survey: 2023-11-09 - 1190 Dixie Road FS128 - Office Topo  
Topographic Survey including tree trunk caliper: 2024-03-19 - 1190 Dixie Road FS128 - Office Topo North Side

Appendix 4: Excerpt: Cultural Landscape Inventory: City of Mississauga, January 2005 (page 83)

Appendix 5: City of Mississauga’s Template Design and Standards for New Fire Stations (October 2020 version)

Appendix 6: Preferred Option I – Site Plan Drawing

Appendix 7: Shoalts Engineering report: Proposed Relocation of Lakeview Golf Club Cottage  
Apr26, 2023

Appendix 8: Alternate Site Options 4a, 4b, 5A and 5b

Appendix 9: Chain of Title Report, Parcel Register, and Property Index Map

## 1.0 Introduction

+VG Architects (The Ventin Group, Toronto, Ltd.) was retained by the City of Mississauga in December 2023 to develop a Heritage Impact Assessment that includes feasibility analysis for a Fire Services Station (FS 128) at the site of the Lakeview Golf Course. The project scope includes the following:

- Feasibility of a single story/2 Bay Fire Station design and site fit analysis, including general massing (preliminary floor plans and elevations) as per the City of Mississauga Template Design and Standards for New Fire Stations).
- Determining the impacts to the heritage golf course, as required in the City of Mississauga's Heritage Impact Assessment Terms of Reference.
- Recommendations for heritage impact mitigation measures.
- Liaise with relevant project stakeholders in Mississauga Fire and Emergency Services (MFES), Realty Services, and Recreation, to include documentation in HIA to support the application to the Heritage Advisory Committee.
- Aid in supporting City staff to prepare for presentations to the Heritage Advisory Committee (HAC) by Heritage Planning staff. Consultant to provide HIA, diagrams and drawings as needed, to aid in and assist with presentation to HAC and Council.

The Lakeview Golf Course is designated by Mississauga By-law 008-2010 under Part IV of the Ontario Heritage Act as an architectural/cultural landscape. Lakeview Golf Course is also included in the City of Mississauga Cultural Landscape Inventory.

### 1.1 Property Information

Lakeview Golf Course  
1190 Dixie Rd, Mississauga, ON L5E 2P4

Legal description  
CON 2 SDS PT LTS 6, 7, 43R35295 PTS 2, 5

Assessment code  
GOLF COURSE, REGARDLESS OF OWNERSHIP

Ward  
1

Area  
437,602.11 SM

## 2.1 Detailed Site History

### 2.1.1 Formation of Lakeview Golf Course

First established in 1896, Lakeview Golf and Country Club was known as the High Park Golf Club with a golf course on a fifty-acre plot of land on the west bank of Grenadier Pond. In 1907 the Club received an eviction notice and sought another site. Three were considered. The current location of Lakeview Golf Course was selected. The golf club relocated to its present site in 1907.

### 2.1.2 Early History of the Site

Lakeview Golf Course originally comprised the south half of lot 6 concession 2 south of Dundas Street, where the Reuben Dunn Farm was located. The Grand Trunk Railway tracks bisected the property.

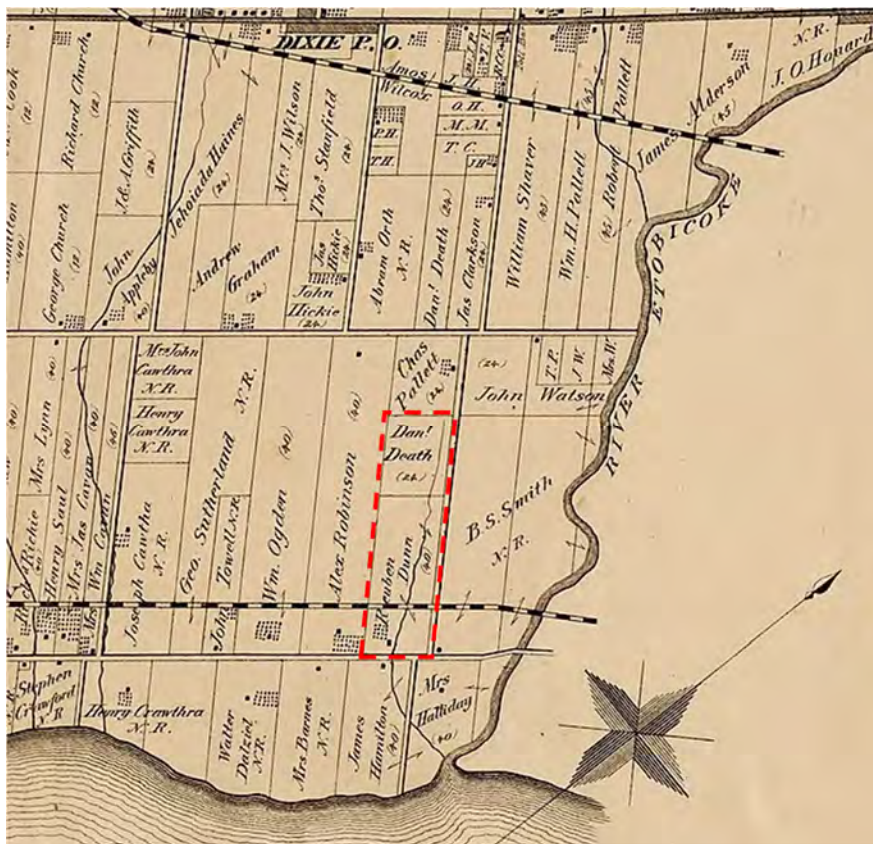

Image 2.1.1: Annotated historic map (1877 Toronto Township) showing the railroad, applewood creek and parcels of farmland prior to the establishment of Lakeview golf course. (Peel Region Archives, see [https://commons.wikimedia.org/wiki/Category:Illustrated\\_historical\\_atlas\\_of\\_the\\_county\\_of\\_Peel,\\_Ontario#/media/File:1877\\_Peel\\_Atlas\\_pg24-25\\_Toronto\\_Township\\_Southern\\_Part\\_PN2019\\_21640-3.jpg](https://commons.wikimedia.org/wiki/Category:Illustrated_historical_atlas_of_the_county_of_Peel,_Ontario#/media/File:1877_Peel_Atlas_pg24-25_Toronto_Township_Southern_Part_PN2019_21640-3.jpg))

The initial design for the new course was made by Rosedale Golf Club Professional, W.J. Lock. Nine holes were completed below the tracks in 1907, the remaining above the tracks in 1908. According to an article published in Outdoor Canada, in 1907, the ninth hole was 750 yards long. It was purported to be the country's longest.

The Dunn farmhouse was converted and used as the first clubhouse.

To eliminate the hazard associated with crossing the railway tracks, the Club sold the parcel of land to the south of the tracks and in the spring of 1911 purchased forty-one acres of the former Fred Death farm, located at the north end of the course. A small parcel of the newly purchased land was reserved for Leslie Pallett, where he built a house at 1400 Dixie Road. This property is known as the McMaster house and is currently part of the Fairways condo properties.

On March 31, 1911, the club received a new name and was registered on July 20th as the Lakeview Golf and Country Club. The Board launched the new name the following year, in 1912. The main shareholders at the time, A.T Phelan and H.W. Phelan, built a new thirty-room clubhouse north of the railway tracks.

During World War I, the club responded to a government call for produce and grew vegetables and hay on its property. The entire eighteenth fairway served as a vegetable garden.

#### Listing of Owners Prior to the Renaming of the Club:

The following information has been gathered from available publication (Lakeview: Journey from Yesterday, pp. 67-75) on the transfer of land and transactions between private owners and the golf club:

- April 21, 1907, High Park Golf Club purchased 97 acres (38.8 ha) Rueben Dun farm, Lot 6, Con. 2, SDS on the west side of Third Line (currently Dixie Road).
- March 9, 1911, Robert Ewing bought 50 acres (20 ha) on the former Fred Death farm.
- March 20, 1911, Robert Ewing sold 41 acres (16.4 ha) of the former Fred Death farm to the golf club for \$12,605.
- March 20, 1911, Robert Ewing sold 6 acres (2.4 ha) to Leslie Pallet for \$4,800.
- March 31, 1911, the golf club sold 31.5 acres (12.6 ha) of land below the tracks to Mary McEvay for \$15,750.

For additional information on the site history please refer to the Chain of Title Report, Parcel Register, and Property Index Map provided in Appendix 9.

### 2.1.3 Transformations after the first World War

In 1921 Club President Frederick A.N. Powell commissioned New York golf architect, Herbert Bertram Strong to design a \$35,000 championship layout. Strong was an Englishman born in Ramsgate, Kent. He immigrated to New York in 1905 but had previously served as professional and club maker at St. George's, Sandwich.

Construction management was awarded to Thompson, Cumming and Thompson, recognized as a prominent Canadian golf construction and design firm. In the spring of 1921, however, TCT was dissolved, and projects were taken over by Lewis and Thompson. (see [Lakeview Golf Course — Stanley Thompson Society](#))

In the fall of 1923, the Club purchased an extra strip of land on the west, as per Strong's recommendation. It allowed for additional space between the 5th, 6th and 7th holes.

For further discussion of the significance of Herbert Strong's contribution to the design of Lakeview golf course, refer to sections 2.15 and 2.16 below.

#### Events After the Fire of 1939

In July 1939 a fire destroyed the clubhouse building. This was a time of financial turmoil as the clubhouse was not covered by insurance.



*Image 2.1.2: Lakeview golf club after the fire of 1939 (Lakeview: A Journey from Yesterday)*

The golf course was purchased in 1940 by Harry Phelan and Bill Purtle for \$400,000. They built a new clubhouse and ran the club semi-privately. It is noteworthy that from 1940 to 1957, the golf course was exclusively used by men as women were prohibited from using the facility.

Between 1956 and 1964, the Township of Toronto (later City of Mississauga) leased the property and took over the operations of the course. The Township made the course available for public use.

The municipality took ownership in 1965.

### 2.1.4 The Greenskeeper's House

The greenskeeper's house, also referred to as superintendent's house, was built in 1913 on the north end of the course.

Based on the historical background included as part of the designation statement: "The superintendent's residence was built in 1914 for the course's golf pro, Alfred Russell". This attribution however is not consistent with information provided elsewhere. Based on historical research conducted by Kathleen A. Hickson and presented in her book, *Lakeview: A Journey from Yesterday*, "the greenskeeper Bert Hawkings lived in a house on the north end of the course and maintained the grounds." (p.68) The same publication includes a black and white photograph of the house (Image 2.3 below) with the caption stating: "this one storey cottage was built for Bert Hawkins..." which entails the house was from the outset the residence of Bert Hawkins. Hickson confirms that at the time she conducted her research (c. early 2000s), the house was the residence of the grounds superintendent, hinting at an uninterrupted pattern of usage through the years.

Given the discrepancy between the two sources, it is not possible to state with certainty who was the first resident of the house.



*Image 2.1.3: Historic image of the greenskeeper's house, copied from Lakeview: Journey from Yesterday.*



### 2.1.5 Herbert Strong: Golf Course Architect

Herbert Strong was hired by the Club president Frederick A.N. Powell to design the golf course at Lakeview. Born in Ramsgate (UK), Strong had emigrated in 1905 to the United States, where he began his career initially as a golf pro, and later a golf course architect, (Wikipedia). Prior to his work at Lakeview, Strong had contributed to major golf course design projects such as the Inwood Golf Club in Far Rockaway, where he was not only responsible for the design of several championship venues, but became Inwood's pro from 1912 to 1916 (<https://www.inwoodcc.org/about>)

Lakeview golf course is one of the few examples of the Herbert's Strong designs in Canada. He is also associated with the design of Club Laval Sur Le Lac, Montreal; Manoir Richelieu, Quebec. (designation statement, appendix 1)

### 2.1.6 Herbert Strong's Contribution to the Design of Lakeview Golf Course

#### Overcoming the Constraints of the Site:

The 18-hole golf course at lakeview is contained within a rectangular plot with Applewood creek running through it. The creek is a natural winding feature, which the golfers have to navigate as they go through their rounds. It enters the site at the northwest corner of the golf course, next to the 16th tee, and winds its way southward while changing direction to become a central feature of the topography. In addition to the creek, the site is characterized by the narrow configuration of the rectangular plot. Herbert Strong was able to overcome the constraints of the site by adapting his design to the topography and existing features.



*Image 2.1.4: View of the creek showing recent intervention of bridges in 2021; image courtesy of Beyond the Contour [Lakeview, Revisited - Beyond The Contour](#)*

Strong's Design Objectives and Strategies:

With the fairways compressed together to conserve on space, the layout of the golf course capitalizes on existing topography, trees, and man-made features to create challenging conditions for the golfers, while providing stunning views of the landscape. Herbert Strong has been dubbed a “greens artist” and recognized for having “carefully sculpted and formed these greens in accordance with the subtle nuances of each hole.” (Designation statement - Appendix 1)



*Image 2.1.5: View of 16<sup>th</sup> tee (image: City of Mississauga website)*

The strategic positioning of the fairways in relation dramatic ridgelines, and obstacles such as sand bunkers (as shown in picture above at the 16th fairway, image: City of Mississauga website) create picturesque qualities that enhance the player's experiences. Placing the large greens near existing ridgelines associated with the creek, buried tributaries or hills were some of the strategies used by Strong to exploit aesthetic possibilities of the site, while minimizing the amount of construction required to achieve them.

### Creating a Challenge for the Players:

The strategic placement of hidden bunkers, water features, and other obstacles and hazards within the golf course demonstrate Strong's penchant for creating challenge along the course. Strong designed the greens to test the golfers' abilities, often incorporating dogleg strikes, or creating blind spots that challenged the golfer when aiming for the hole.

The severe slopes, ridges, tiers, bumps, and bowls create a variety of conditions for the golfers, while contributing to the values of the site as a cultural landscape. The aesthetic qualities of the golf course have been described in terms of the variety and contrast between each hole. A good example of the use of this strategy can be seen in the southwest corner of the golf course at the 7th tee. While the 5th and 6th holes are conceived as long and straight trajectories, "the slightly downhill and dogleg right design of the 7th hole provides a contrast characterizing Strong's approach to golf course design. (Beyond the Contour, article, article by Alex Hunter [A Case For Revitalizing Canada's Public Golf Courses At Lakeview - Beyond The Contour](#))



Image 2.1.6: View of holes 6 and 7 at the southwest corner of the golf course (image, City of Mississauga <https://www.mississauga.ca/golf/lakeview/>)



Image 2.1.7: 11th hole, looking north, showing bunkers (image: Beyond the Contour [Lakeview, Revisited - Beyond The Contour](#))

#### The Role of Trees

The site includes a significant number of mature trees which create barriers between the fairways. The trees, mostly maple and oak trees, not only shield the players from the errant balls, but provide a visual appeal of the landscape, which is an important attribute of the site as a cultural landscape. The trees in combination with the landscape are also significant components of this urban landscape and parkland.

#### The Golf Course Constructor and the Connection with Stanley Thompson and George Cummings:

According to the designation statement, Canadian designer and constructor of Golf Courses, Thompson Cumming and Thompson completed the construction of Strong's design in 1922. Both George Cumming and Stanley Thompson were prominent golf pro and golf course designer-builders.

The noted attributes including both the natural and manmade design features, and the aesthetic and visual qualities of lakeview golf course account as reasons for the designation of the golf course as a cultural landscape and built environment. (Cultural Landscape Inventory, Lakeview Golf Course L-PA-5).

## 2.2 Existing Structures

### 2.2.1 Description of the Existing Property

Lakeview Golf Course comprises a narrow rectangular tract with an extra strip of land on the west side. The golf course is located on the west side of Dixie Road. The course slopes south towards Lake Ontario. Applewood Creek meanders through the property on a north-south axis. There is also a substantial hill at the southeast corner.

There are several structures on the property including a clubhouse and a cart shed at the south end of the parking lot, a maintenance facility at the north end of the parking lot, and the superintendent's residence, at 1392 Dixie Road, at the northeast corner of the property. The existing golf clubhouse underwent major renovations in 1999.



*Image 2.2.1: Aerial view of the golf course. North is positioned to the right of the image with Dixie Road visible at the bottom.*

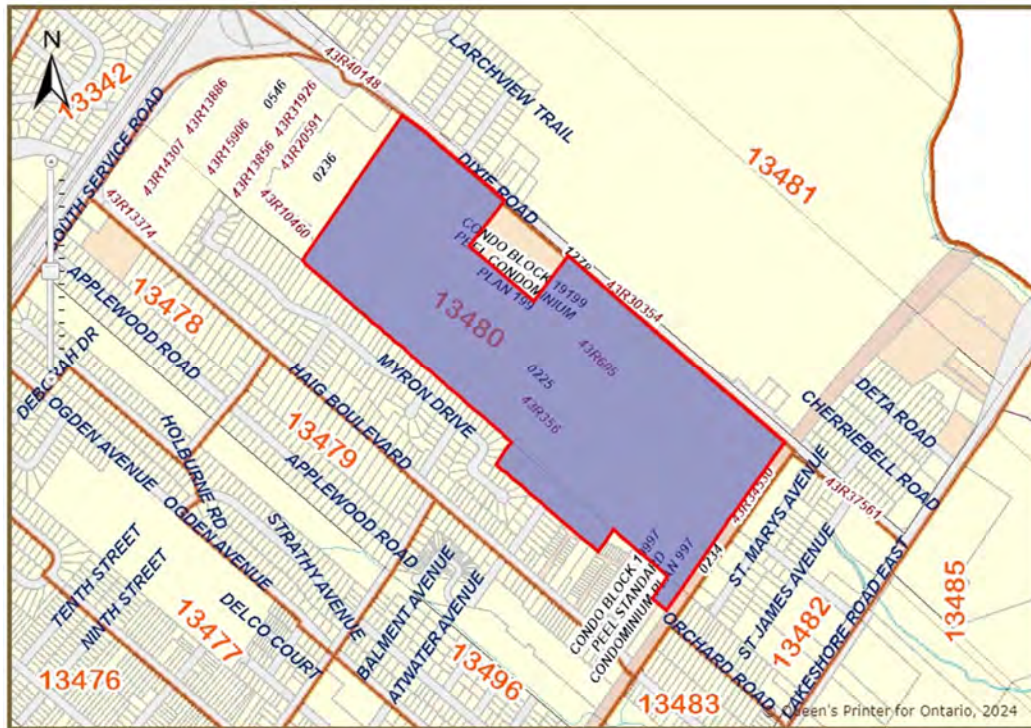

Image 2.2.2: Property Index map of land parcel register, showing existing land uses. Source: Ontario Land Registry Office (Property Index Map Peel, No. 43)

## 2.2.2 Golf Course

The golf course is 6263 yards long with the majority of the holes between 350 and 475 yards apart. The first nine holes are in the south-western half with the last nine holes in the northeast.

Due to the site's geometry, the fairways are generally orientated north south as narrow strips interceded by trees. Herbert Strong's design conveys how the architect capitalized on natural features to create challenging conditions within the golf course. In addition to natural hazards, including the creek, topographic undulations and vegetation, Strong constructed hazards. These include sand traps and water features, though the large pond was added later for irrigation purposes. Strong's bunkers are large, deep and subtly hidden.

Most of the large greens are at or near dramatic ridgelines associated with the creek, buried tributaries or hills.

## 2.2.3 Greenskeeper's Residence

Built circa 1914, the greenskeeper's residence (alternatively referred to as the superintendent's residence) is located on the north side of the Fairways condominium development, accessed from

Dixie Road. the building is categorized as an Edwardian style bungalow. Its dominant exterior features include a hipped roof, a tall chimney and a classical pediment at the centre. A veranda, with its floor elevated six steps from grade, provides a sheltered space in front of the main entrance.

Short colonettes and brick piers support the extended eaves. A pattern of three raised vertical lines (with the middle one longer than the outer two) adorn the carved wood elements of each colonette.



*Image 2.2.3: Front of the building showing the veranda, and the main entrance, flanked by the two bay windows. Source: +VG Architects.*

The building is approximately 30' wide by 44' long, constructed of load-bearing two-wythe brick walls with a partial basement. There is a crawl underneath the front third of the house. The floors, partitions, and roof are of conventional wood framing, and the interior of the brick walls on the main floor are covered with wood lath and plaster. The brick walls in the basement and the crawlspace are exposed masonry, although there are a few areas where cement parging has been applied to the wall surface. There are three interior bearing walls of brick masonry in the basement. The exterior walls have been clad vinyl siding.

The stairs to the basement are at the rear of the house, appended to the back of the kitchen. A brick wall separates the stairs from both the kitchen and the basement. There is a crawlspace under the front third of the house, separated by a masonry wall from the remainder of the basement.

Two bay windows on the front of the house are supported by cantilevered floor joists. The front porch wood framed floor structure is anchored to the front wall of the house and supported by the four brick piers.

All of the interior ground floor walls are wood framed partitions. The floors are of Douglas fir T&G, laid directly on the joists.

The interior layout is mainly organized around the central corridor which bisects the house with rooms on either side. The windows appear to be the original single-glazed wood single-hung units for the most part, with aluminum exterior storm windows over them.



*Image 2.2.4: image of greenskeeper's residence (identified as Lakeview golf residence on City of Mississauga website, Photo source: City of Mississauga Inventory of Heritage properties, Inventory No. 549; see <https://www.mississauga.ca/apps/#/property/view/heritage>)*

### 2.2.4 History of Alterations – The Greenskeeper's House

Most of the doors and trims inside the greenskeeper's house appear to be original, however, there is evidence of modification to interior walls and finishes.

An enclosed rear porch and deck are extensions or a modification of an original structure. No records have been found to clearly explain the history of these modifications.

According to historical information provided as part of the Designation Statement "The covered porch is believed to be a possible later addition that softens the overall lines of the building." This may be inaccurate as the veranda appears to be an integral part of the design.

Reviewing City of Mississauga records on past building permits for the property include records of alterations/rebuild of the existing porch in 2010.

Date: \_\_\_\_\_ Scope of work based on Address Description  
 2010-02-18 ALTERATIONS - REBUILD EXISTING FRONT PORCH - GREENSKEEPERS  
 HOUSE - LAKEVIEW GOLF COURSE.

The brick piers have been reconstructed with reclaimed brick. The original stone caps are in place. The steps leading up to the porch are built of pressure-treated lumber.



## 2.2.5 History of Site Development

Herbert Strong's design for the golf club was fully implemented by 1923 after the purchase of a strip of land on the southwest corner, which allowed for additional space between the 5th, 6th and 7th holes.

Strong's original design was for the most part preserved until the municipality took ownership in 1965. When the golf club became a public resource, the municipality implemented a series of minor modifications to support usage by the public and to ensure safety within the course. A list of the modifications can be found in the 2007 Proposed Heritage Designation document (see Appendix 1 to this HIA document).

In addition to minor adjustments to the angle of the tee box and fairways, a pond was added for the purposes of irrigation, a large sand trap to catch westward balls and a sixteen high foot fence have been installed to demarcate the boundaries of the golf course.

## 2.2.6 Fairways Condominium

The most significant change to the site occurred in the early 1970 when the Fairways condominiums were built. An historic photo, likely from the 1950s (see Image 2.2.5 below) shows the golf course prior to this intervention. Based on the photo, it appears the location where the Fairway condominium is currently located had been previously demarcated separately from the rest of the golf course, protruding into the organic flow of the fairways to the west and south. The plot associated with the McMaster house can be identified as the rectangular parcel to the south of the square plot which later became the site of Fairways Condominium buildings.



*Image 2.2.5: Aerial view prior to the development. 1956, photo see <https://beyondthecontour.com/lakeview-revisited/>*

### 2.2.7 Applewood Creek Erosion Control Project

Based on a design brief drafted in May 2021, City of Mississauga Transportation and Works department has proposed a series of measure to naturalize Applewood creek and prevent erosion of the embankments. This two-year project would impact the heritage elements within the landscape, however, efforts have been made to preserve the original layout and features of the golf course as they had been originally conceived by Strong. While some of the trees will be lost, new one will be planted to replace them. The interventions include the addition of new bridges.

<https://www.mississauga.ca/projects-and-strategies/environmental-assessments/applewood-creek-erosion-control-lakeview-golf-course/>

## 2.2.8 Significance of Cultural Heritage Resources and their Attributes

Lakeview Golf Course is designated under Part IV of the Ontario Heritage Act. The property is a culturally significant resource for having values associated with the following criteria:

- Historical
- Design
- Contextual

Historical values are based on:

- The history of golf tournaments, including the Canadian Open and the initiation of the Ontario Open, Ontario Amateur Open and Champion of Champions Tournament
- The players and winners of these tournaments
- Local golf history as well as Mississauga's history as a place of recreation for residents of York (now Toronto)
- The designer Herbert Strong, a world-renowned golf course architect
- The design-builder Thompson Cumming and Thompson, an important Canadian designer and constructor of golf courses

Design values are based on:

- The golf course is one of few remaining examples of a tree-lined parkland golf course layout in an urban setting
- Rare and representative surviving example of a Herbert Strong designed course of the early twentieth century
- Displaying a high degree of craftsmanship and artistic merit

Contextual values are based on:

- Large landmark that defines and maintains Lakeview's golf course landscape
- The golf course is physically, functionally and historically linked to the community, from which it took its name
- the Grand Trunk (now Canadian National) Railway tracks that are part of both its formative history and history as a destination for York residents.
- Physical and historical connections to the Toronto Golf Club

According to the property designation statement (Bylaw No. 008-2010, Date: January 20, 2010, refer to Appendix 2), the Key Attributes that reflect values of the property and contribute to the designation of the site as a culturally significant resource are as follows:

- One of the few remaining traditional tree-lined parkland layout golf courses in an urban setting
- One of the few remaining courses designed by golf course architect Hebert Strong

- its location, orientation and dimensions
- its mature trees and other vegetation and their/its placement
- the inclusion of 18 holes and their layout
- the placement and orientation of the original tees, fairways, greens, bunkers and other hazards, natural or otherwise, on varying topographical features
- the original 11th and 18th tees - these should not be dug up, nor should any vegetation be planted on them
- the bunker in front of the 9th green - this is integral to the original design
- the shape and form of the greens
- A site of important golf tournaments

Of particular importance are the historical and design values associated with the design of the golf course and its features. The architect Herbert Strong has been credited as having, “carefully sculpted and formed (the) greens in accordance with the subtle nuances of each hole.”

Strong construed each green to emphasize strategy. One technique he often used to produce this affect was to design the greens and fairways so that they would form doglegs or simply undulate. Some fairways produced blind shots, which are rare.

The placement, orientation and form of the tree lines, greens, fairways, sand traps and the original water features and tees all contribute to Strong’s carefully designed course.

Historically, the golf course is important as it hosted many important tournaments including the Canadian Open in both 1923 and 1934, and Ontario Public Course Championship in 1971.

### Greenskeeper’s House

The greenskeeper’s house is noted as one of the Attributes of the golf course:

- “The staff dwelling at 1392 Dixie Road, with its broad gently pitched roof that covers the veranda; chimney; Edwardian elements, including a Classical pediment, the short colonettes, with their decorative mouldings, on brick piers that support the veranda roof, the veranda balustrade, the fenestration, including the bay windows and sidelights flanking the main entrance, and wood siding.” (Quoted from the Designation Statement, January 20, 2010)

## 2.2.9 Designation as a Cultural Landscape

Lakeview Golf course heritage value is best described as a cultural landscape.

Lakeview Golf Course is included in the City of Mississauga Cultural Landscape Inventory as item L-PA-5 for the following attributes (refer to Appendix 4):

## LANDSCAPE ENVIRONMENT

- Scenic & Visual Quality
- Natural Environment
- Horticultural Interest

## BUILT ENVIRONMENT

- Aesthetic & Visual Quality
- Consistent Early Environs (pre-World War II)
- Consistent Scale of Built Features

## OTHER

- Historical or Archaeological Interest

### 2.2.10 Heritage Plaque



Image 2.2.6: Heritage Plaque for Lakeview Golf Course. Source: City of Mississauga

Close-up image of the plaque is available on City of Mississauga Website, see <https://www.mississauga.ca/city-of-mississauga-news/news/lakeview-golf-course-top-rated-among-canadas-municipal-courses/>

The plaque states:

“In 1896, the High Park Golf Club was formed. Situated in the Township of Swansea, the modest 18 hole course occupied 50 acres along the west bank of Grenadier pond. Forced to move by a rapidly growing city, the club relocated to its present site in the spring of 1907, and in January 1912 the Directors decided to change the name to Lakeview Golf and Country Club Limited. For the next two decades Lakeview enjoyed a place at the top of Canada’s golfing community. This included hosting such championships as the 1914 C.P.G.A., the first Ontario Open and Amateur Championships of 1923 and two National Canadian Open Championships: 1923 and 1934. However, the turning point in the club’s history occurred on Friday July 21, 1939 when a fire destroyed its magnificent 30 room clubhouse. The club was purchased privately the following year and operated semi-privately for the next 15 years. The Township of Toronto (later the City of Mississauga) leased the club from 1956 to 1964 and eventually purchased Lakeview Golf Club in 1965. Lakeview has since operated as a pay as you play golf course that the community enjoys to this day.”

## 2.3 Existing Conditions

### 2.3.1 Introduction

This section has been developed to largely focus on the existing conditions of the proposed development site at the greenskeeper's house and the landscape immediately around the greenskeeper's house.

The existing 18-hole Lakeview Golf Course

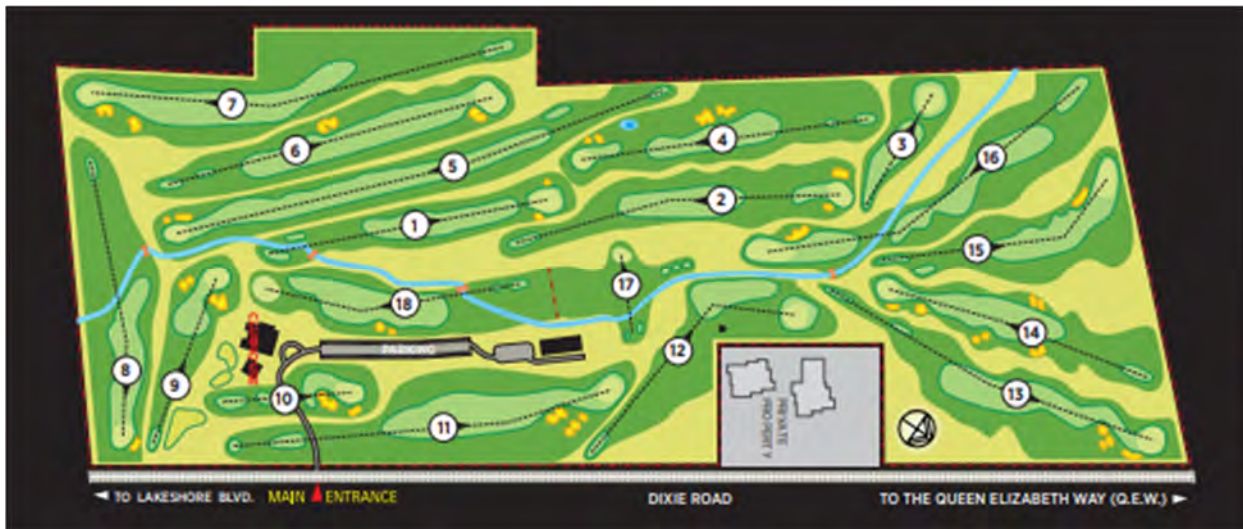

*Image 2.3.1: Score card course layout diagram for Lakeview Golf Course including numbering of the holes. Note that the location of the Greenskeepers house is near the north arrow. Source: City of Mississauga.*



*Image 2.3.2: Aerial image of the northeast corner of the Lakeview Golf Course. The Lakeview course is shown below and to the left of Dixie Road. The proposed site for the proposed fire station is outlined with a dashed yellow line. Source: Google Maps.*

The site proposed by the City of Mississauga for this HIA is located on the west side of Dixie Road north of the existing Fairways Condo development. The approximate position of the development is shown with the dotted yellow line in Image 2.3.2. On the east side of Dixie Road are several detached houses. Directly across Dixie Road from the Fairways Condo development is the Toronto Golf Club. The proposed development site is adjacent to Fairway No. 13. The site is the location of the greenskeeper's house, which is considered a heritage attribute of the Lakeview Golf Course. Note that the aerial photography shows the site prior to the gravel parking lot being constructed between Dixie Road and the greenskeeper's house.



### 2.3.2 Greenskeeper's House



*Image 2.3.3: August 2023 view from Dixie Road towards the greenskeeper's house. Source: Google Streetview.*



*Images 2.3.4 and 2.3.5: Front elevation and side walls of the greenskeeper's house facing onto the gravel parking lot. Source: +VG Architects*

The photographs above show the greenskeeper's house on January 5, 2024 during a site visit attended by +VG Architects. The front yard of the house is currently used as a gravel parking lot for maintenance equipment associated with the golf course. The house is currently used as a storage shed for landscape items such as benches, ABS irrigation piping, PVC pipes, hoses, and hole/fairway signage. Some interior elements appear to be original including some door hardware and the fireplace mantel with decorative wood and mirror. None of the interior elements of the house are considered heritage attributes under the designation By-law.



*Image 2.3.6: Front room includes a fireplace mantel with decorative carved wood and mirror.*

Source: +VG Architects



*Image 2.3.7: Rear yard of the greenskeeper's house. Source: +VG Architects*

The site of the greenskeeper's house also contains a garden shed, various partially collapsed wood fences, yard waste, construction materials, and a wood deck at the south corner of the house. None of these elements are regarded as original or having heritage significance.



*Image 2.3.8: South corner of the greenskeeper's house. Source: +VG Architects.*

The south corner of the house has been altered with non-original poor-quality construction of exposed wood studs and bare plywood. It appears that this corner of the building may have originally been a screened-in porch or an open-air covered porch set in under the main roof. The remainder of the exterior brick walls have been covered with vinyl siding. An investigation by City staff showed that at the area of the investigation fasteners for the strapping that supports the vinyl siding have been attached into the brick rather than into the mortar joints. The roof shingles are curling and appear to be at the end of their service life.

The small shed-roofed projection on the rear of the house contains the stairs to the basement. It is possible that the stairs were originally exterior stairs that were later enclosed.



*Image 2.3.9 and 2.3.10: Brick foundations at the north side. Source: +VG Architects.*

Brick foundations are visible at the exterior and interior and exhibit extensive efflorescence, spalling and mortar joint degradation, all likely due to wicking of ground water in the masonry assembly. Some repointing has been done to the exterior of the foundation walls with inappropriate mortar in local areas. Stepped cracking is visible in several areas with loose bricks. There appears to be no effective parging, foundation drainage, or waterproofing at the exterior face of the foundation wall below grade.



*Image 2.3.11: Crawl space under the front third of the greenskeeper's house.*

The front half of the house has a crawl space under it with a bare earth floor. The joists and floor boards of the ground floor above do not have a vapour barrier installed. Fiberglass insulation was installed between the joists at some point in the past. As much as 50% of the batts have fallen out of the joist cavities. These current conditions do not meet the Ontario Building Code with respect to crawl spaces, vapour barriers, and insulation.

---

#### Definitions

Excellent (E) – Excellent conditions with no defects or deterioration observed

Very Good (VG) – Very good condition with very minor defects or deterioration

Good (G) – Good condition with minor defects or deterioration that do not significantly affect the function

Fair (F) – Some defects or deterioration observed but do not significantly affect the function

Poor (P) – Serious damages, defects or deterioration that affect the function

Failure (X) – No longer functioning or complete failure

---

Overall, the greenskeeper's house, otherwise known as the Superintendent's Residence, or the Staff Dwelling, has building elements or systems that range from good condition to failure.

### 2.3.3 Natural Features

The area of the site surrounding the greenskeeper's house contains several stands of mature trees, some of which line the rough surrounding the fairway of hole number 13. These trees have been documented in the Topographical Plan of 1190 Dixie Road, which is included in Appendix 3. The largest of the trees includes specimens with trunk diameters of 0.9m, 1.0m, 1.0m and 1.2m as shown by the blue arrows in the image below (Image 2.3.12). The trees, which are an integral part of the Heritage Cultural Landscape of the Lakeview Golf Course are to be carefully considered in an evaluation of heritage impact on the golf course.

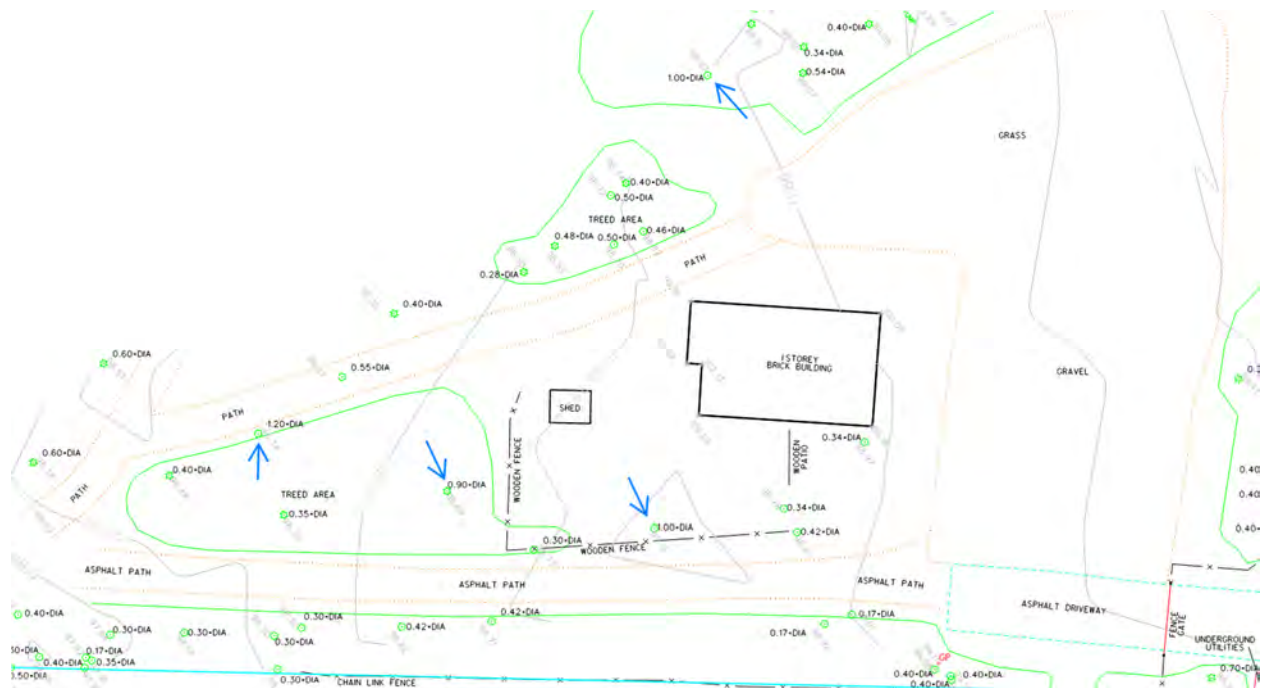

*Image 2.3.12: Excerpt from Topographic Survey including tree trunk caliper: 2024-03-19 - 1190 Dixie Road FS128 - Office Topo North Side. Survey provided by City of Mississauga, Transportation and Works Department, Work Operations and Maintenance Division, Technical Services Section, Surveys and Inspectors.*

The greenskeeper's house is an original part of the Lakeview Golf Course site, and it is a heritage attribute of the site. It is however the opinion of the authors of this HIA that the house is an ancillary element of the golf course that is not in a prominent location, and with its separate driveway off Dixie Road, and fences partially separating it from the golf course, it seems separate and apart from the landscape of the golf course. The natural and altered landscape of the site, including

waterways, contours, trees and other elements that are an integral part of the golf course should be considered the primary heritage asset.

### 2.3.4 Relevant Municipal or Agency Requirements

As required by the City of Mississauga's Terms of Reference for Heritage Impact Assessments, this section describes relevant municipal or agency requirements which will be applied to the subject property.

#### 2.3.4.1 City of Mississauga Plans and Policies

Mississauga Official Plan guides how the City will grow and develop, as required by the Ontario Planning Act. The Official Plan provides the basis for Mississauga's land use and urban design, in line with the City's Strategic Plan. Its policies address important parts of city-building that affect everyone that lives and works in Mississauga, including transportation, housing, culture and heritage, the environment, and the economy.

The Official Plan also sets standards for the review and approval of development applications in the City. The goal of these policies is to create inclusive communities where people are connected, supported and allowed to flourish. The goals as they relate to the conservation of culturally significant resources are contained in part 2 (City Wide Policies), subsection 7 (Complete Communities):

7.1.8 Mississauga will recognize the significance of and act responsibly in the identification, protection, and enhancement of structures, sites, cultural heritage landscapes, environments, artifacts, traditions, and streetscapes of historical, architectural or archaeological significance.

7.1.10: When making planning decisions, Mississauga will identify, maintain and enhance the distinct identities of local communities by having regard for the built environment, natural or heritage features, and culture of the area.

Sub-section 7.5 Heritage Planning of the Mississauga Official Plan (July 2023 Consolidation) provide direction for development on or adjacent to the Cultural Heritage Resources and Properties:

#### 7.5 Heritage Planning

Heritage planning is the responsibility of the Provincial Government and the City. The Heritage Advisory Committee has been established to advise City Council on matters pertaining to cultural heritage value or interest.



### 7.5.1 Cultural Heritage Resources

Mississauga's cultural heritage resources reflect the social, cultural and ethnic heritage of the city and, as such, are imperative to conserve and protect. Cultural heritage resources are structures, sites, environments, artifacts and traditions that are of cultural, historical, architectural, or archaeological value, significance or interest. These include, but are not limited to:

- structures such as buildings, groups of buildings, monuments, bridges, fences and gates
- sites associated with an historic event
- environments such as landscapes, streetscapes, flora and fauna within a defined area, parks, heritage trails and historic corridors
- artifacts and assemblages from an archaeological site or a museum; and
- traditions reflecting the social, cultural, or ethnic heritage of the community.

7.5.1.1 The heritage policies are based on two principles:

- a. heritage planning will be an integral part of the planning process
- b. cultural heritage resources of significant value will be identified, protected, and preserved.

7.5.1.2 Mississauga will discourage the demolition, destruction or inappropriate alteration or reuse of cultural heritage resources.

7.5.1.3 Mississauga will require development to maintain locations and settings for cultural heritage resources that are compatible with and enhance the character of the cultural heritage resource.

7.5.1.4 Mississauga will encourage other levels of government to enact legislation and develop programs that promote the preservation and rehabilitation of cultural heritage resources.

7.5.1.5 Mississauga will encourage private and public support and the allocation of financial resources for the preservation and rehabilitation of cultural heritage resources.

7.5.1.6 Mississauga will foster public awareness of and commitment to, the protection and enhancement of cultural heritage resources.

7.5.1.7 Mississauga will maintain a Heritage Register of property, including structures and cultural landscapes that should be preserved as cultural heritage resources. The cultural heritage resources in the Heritage Register will be assessed based on their design or physical value, historical or associative value, contextual value and archaeological significance including the aggregation of both natural and cultural heritage resources.

7.5.1.8 The Heritage Register will contain a legal description of the property, the name and address of the owner, a statement explaining the cultural heritage value or interest of the property and a description of the heritage attributes of the property.

7.5.1.9 Character Area policies may identify means of protecting cultural heritage resources of major significance by prohibiting uses or development that would have a deleterious effect on the cultural heritage resource, and encouraging uses and development that preserve, maintain and enhance the cultural heritage resource.

7.5.1.10 Applications for development involving cultural heritage resources will be required to include a Heritage Impact Assessment prepared to the satisfaction of the City and other appropriate authorities having jurisdiction.

7.5.1.11 Cultural heritage resources designated under the Ontario Heritage Act, will be required to preserve the heritage attributes and not detract or destroy any of the heritage attributes in keeping with the Ontario Heritage Tool Kit, the Ontario Ministry of Culture, and the Standards and Guidelines for the Conservation of Historic Places in Canada, Parks Canada.

7.5.1.12 The proponent of any construction, development, or property alteration that might adversely affect a listed or designated cultural heritage resource or which is proposed adjacent to a cultural heritage resource will be required to submit a Heritage Impact Assessment, prepared to the satisfaction of the City and other appropriate authorities having jurisdiction

7.5.1.13 Cultural heritage resources must be maintained in situ and in a manner that prevents deterioration and protects the heritage qualities of the resource.

7.5.1.14 Cultural heritage resources will be integrated with development proposals.

7.5.1.15 Mississauga will regulate use and other matters, as appropriate, for heritage preservation through zoning by-laws.

7.5.1.16 Mississauga will acquire heritage easements, apply restrictive covenants, and enter into development agreements, as appropriate, for the preservation of cultural heritage resources.

7.5.1.17 Public works will be undertaken in a way that minimizes detrimental impacts on cultural heritage resources.

7.5.1.18 Mississauga recognizes the Credit River and Etobicoke Creek valleys as heritage corridors with both prehistoric and historical significance.

7.5.1.19 Mississauga will consider and promote archaeological management plans and cultural plans in conserving cultural heritage and archaeological resources.

7.5.1.20 Mississauga will consider the interests of Aboriginal communities in conserving cultural heritage and archaeological resources.

## 7.5.2 Cultural Heritage Properties

Cultural heritage properties are those properties or defined areas that are determined to be of cultural, historical, archaeological or natural significance and/or value. A heritage designation is applied to properties that have contextual, archaeological, historical/associative and/or

physical/design value that is to be preserved. Properties of cultural heritage value are designated under the Ontario Heritage Act, on the City's Heritage Register, and include listed properties that have not been designated under the Act, but that City Council believes to be of cultural heritage value or interest.

7.5.2.1 Programs for the selective acquisition of cultural heritage properties by the City will be considered. Assistance from the Federal and Provincial Governments will be requested in realizing these programs.

7.5.2.2 Prior to the demolition or alteration of a cultural heritage resource, documentation will be required of the property to the satisfaction of the City, and any appropriate advisory committee. This documentation may be in the form of a Heritage Impact Assessment.

7.5.2.3 Development adjacent to a cultural heritage property will be encouraged to be compatible with the cultural heritage property.

### 2.3.4.2 Region of Peel Right-of Way

The Region of Peel Official Plan, Schedule F-3, provides the general extent of the Rights-of-Way for Regional Roads, and is based on the 2019 Long Range Transportation Plan and does not reflect the growth requirements to 2051. Schedule F-3 provides mid-block Right-of Way requirements.



Image 2.3.13: Annotated excerpt from Region of Peel Official Plan, Schedule F-3, showing a 20-meter Right-of-Way along Dixie Road adjacent to the Lakeview Golf Course.

The image above, which is an excerpt from the Region of Peel Official Plan Schedule F-3, has been annotated to show the location of the Lakeview Golf Course in blue. The current Right-of-Way for Dixie Road, south of the QEW along the eastern boundary of the Lakeview Golf Course is 20 meters,

35

or 10 meters in width each side of the centre line of the roadway. The Region also indicated to Mississauga staff that there may be a land dedication required for a 0.3m reserve behind the property line, excluding any approved access. The east property line of the Lakeview Golf Course corresponds with the 20m Right-of-Way for Dixie Road. For the purposes of this HIA all options investigated have assumed that at least a minimum setback of 3.0m will be required beyond the property line. A 3.0m minimum setback is recommended by the October 2020 City of Mississauga Template Design and Standards for New Fire Stations (3.0 Site Design, Page 47).

### 2.3.4.3 Zoning

The site of the Lakeview Golf Course is zoned OS2-1, with a zone description as “City Park” and a zone category as “Open Space.” Under OS2-1 Exception Zones the following are permitted uses:

- (1) Golf Course
- (2) Recreational Establishment
- (3) Groundskeeper Residence

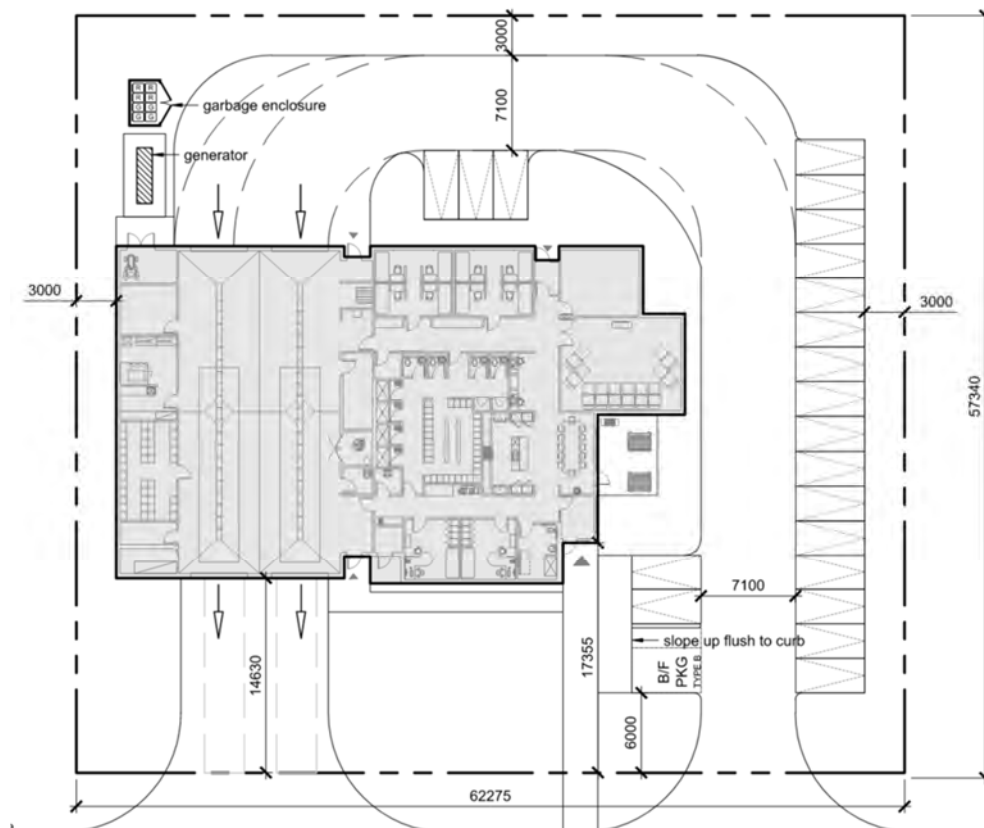

*Image 2.3.14: City of Mississauga zoning map showing the Lakeview Golf Course as OS2-1 zoning, and surrounding zoning designations. Source: City of Mississauga.*

<https://ext.maps.mississauga.ca/Html5Viewer/index.html?viewer=I2BL.HTML5&pin=12596800>

### 2.3.4.4 Template Design and Standards for New Fire Stations

The drawing below, which is an excerpt from the October 2020 City of Mississauga Template Design and Standards for New Fire Stations (refer to Appendix 5), shows the template layout for a two truck one storey site plan.



*Image 2.3.15: Excerpt from the October 2020 City of Mississauga Template Design and Standards for New Fire Stations (page 48).*

The building footprint and gross floor area of the template design is 960 sq m. Minimum site dimensions have a 63 m site frontage and 57 m site depth.

The template design explored the most compact space possible to satisfy the programmatic requirements. The circulation between the apparatus bays and living areas is designed as a continuous u-shape that is clear of obstructions including stairs and ramps. Dorm rooms and captain rooms are situated closest to the apparatus bays. In two storey schemes, the exit stair opens up directly onto the apparatus bays to allow for faster response times.

The fire station standards include current aerial fire truck turning radius and site plan design principles. These have been considered in the development of options for the Lakeview Golf Course site.

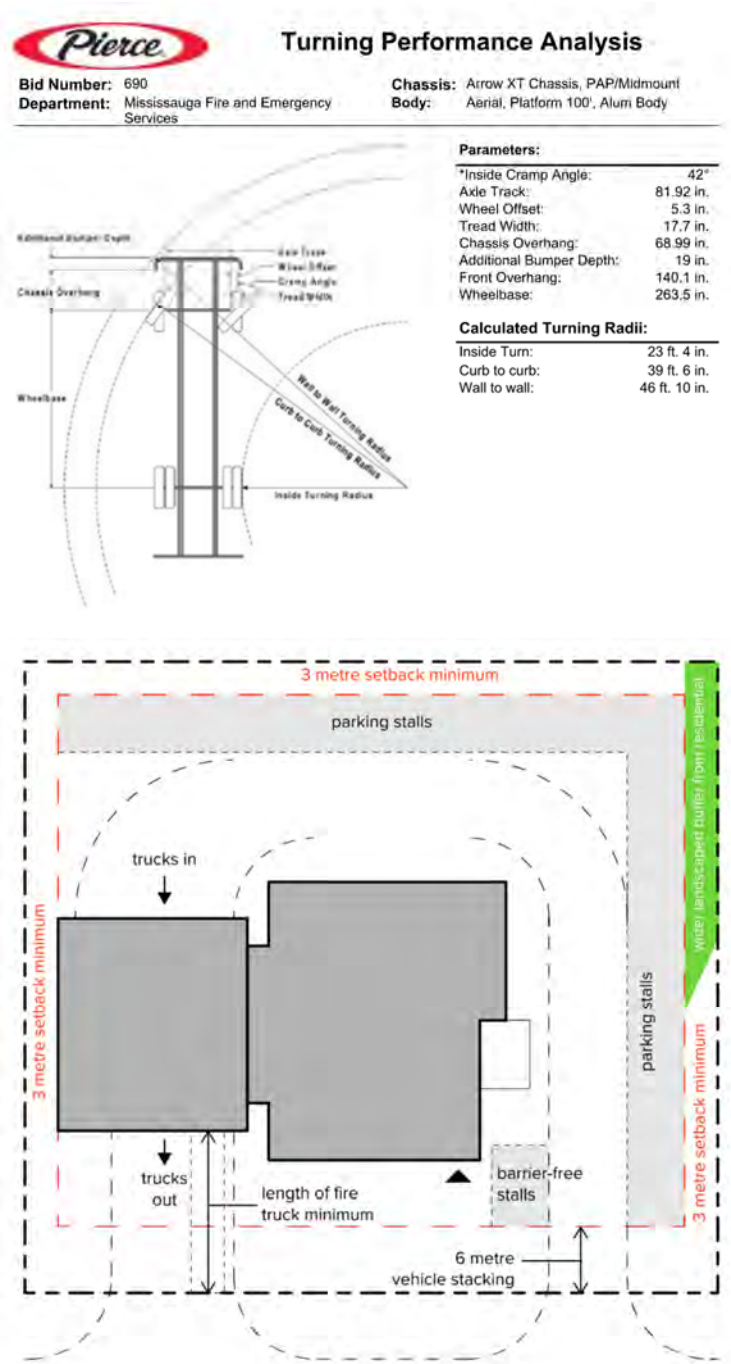

Image 2.3.16: Fire truck turning radius and site plan design from the City of Mississauga Template Design and Standards for New Fire Stations (pages 29 and 47).

### 2.3.4.5 Optional Template Design standard

Mississauga provided the design layout for Fire Station 124 during the development of this HIA to test this layout as an optional design strategy to see if there would be less impact on the heritage attributes of the site, including mature trees in the landscape. Below is an image showing the layout of Fire Station 124. Note that this design is for a mostly one storey, two bay building. A small two storey portion of the building is provided at the apparatus support spaces adjacent to the fire truck bays. This two-storey portion reduces the width of the station, which was seen as a potential benefit for reducing negative heritage impact on the trees of the site.

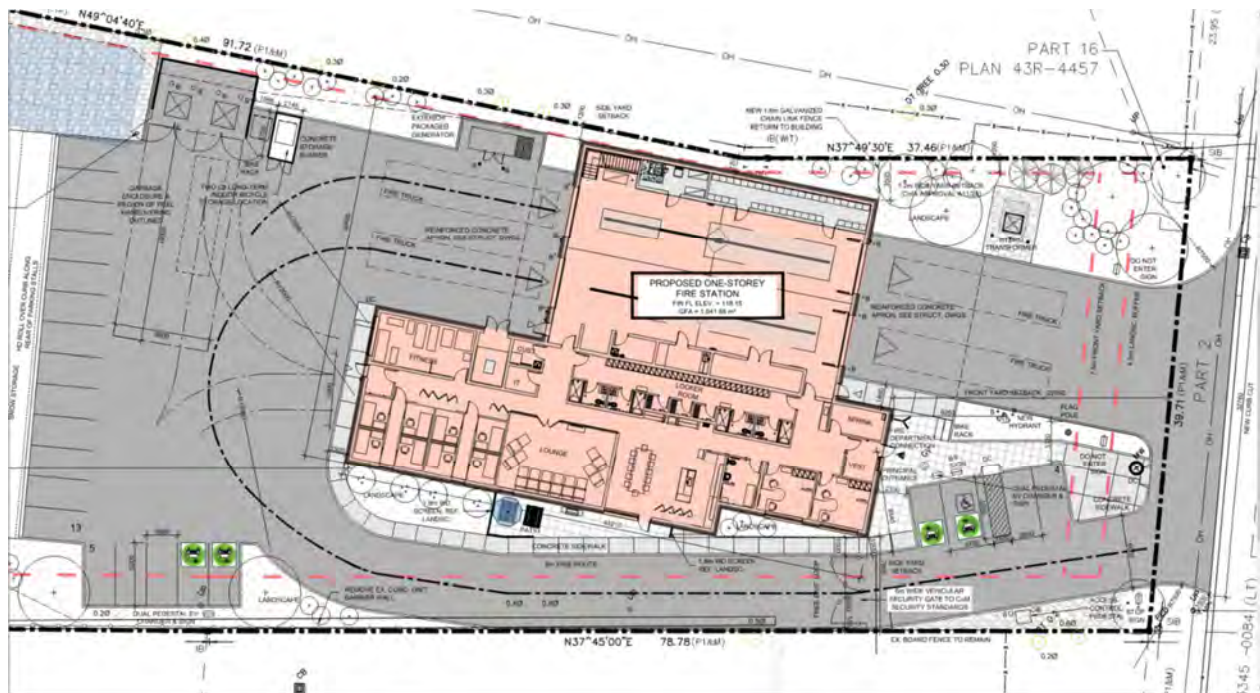

Image 2.3.17: Site Plan layout for Fire Station 124. Source Mississauga.

## 2.4 Proposed Development

The proposed development on the site of the Lakeview Golf Course is for a one storey two bay Fire Station that meets the City of Mississauga's Template Design and Standards for New Fire Stations (October 2020 version).

### 2.4.1 Background

The City of Mississauga has long term plans to develop the south Lakeview area. With the increased population, the south Lakeview area would become underserved by Mississauga Fire and Emergency Services unless additional fire station facilities are provided.

The Lakeview Master Plan, prepared by Mississauga Planning and Development includes metrics on future population growth and development in the Lakeview Community.



Image 2.4.1: Image from the Lakeview Master Plan showing the proposed future Employment Lands. Source: City of Mississauga.



The above image from the Lakeview Master Plan shows the proposed Employment Lands, located south of Lakeshore Road East, between Hydro Road and East Ave. The development includes a combination of low-rise, mid-rise and tall buildings, with a mix of 5,300 townhomes & apartment units providing for Approx. 12,000 people. The anticipated buildout is greater than 20 years.



*Image 2.4.2: Image from the Lakeview Master Plan showing the proposed future Lakeview Village Development. Source: City of Mississauga.*

East of the Employment Lands is the proposed Lakeview Village Development that extends east to Sterson Creek and south to the Lake Ontario shoreline. It includes an additional 16,000 Apartment units for approximately 35,000 people. The anticipated buildout of this area is 20 years.



*Image 2.4.3: Location Plan showing Lakeview Golf Course outlined in green, the location of the future Employment Lands outlined in orange and the future Lakeview Village Development outlined in yellow. Annotated Image from Google Maps.*

Additional Risk Factors:

In addition to the new growth in lakeview, based on the findings of MFES Community Risk Assessment completed in 2023, there are other risk factors to be noted. The following summarizes some of the risk elements to the north.

In addition to the substantial growth proposed to the south of this site, an assessment of risk as it pertains to building stock was completed in 2023. The assessment identified an area to the north of this site bounded by Dundas to the North, The Queensway to the South, Cawthra to the West and the Etobicoke border to the east that has a cluster of **medium hazard industrial properties** with potential high fuel load. Currently response time into this area is well over industry standards and combined with the high-risk building stock, it presents a substantial risk that this new station will help mitigate.

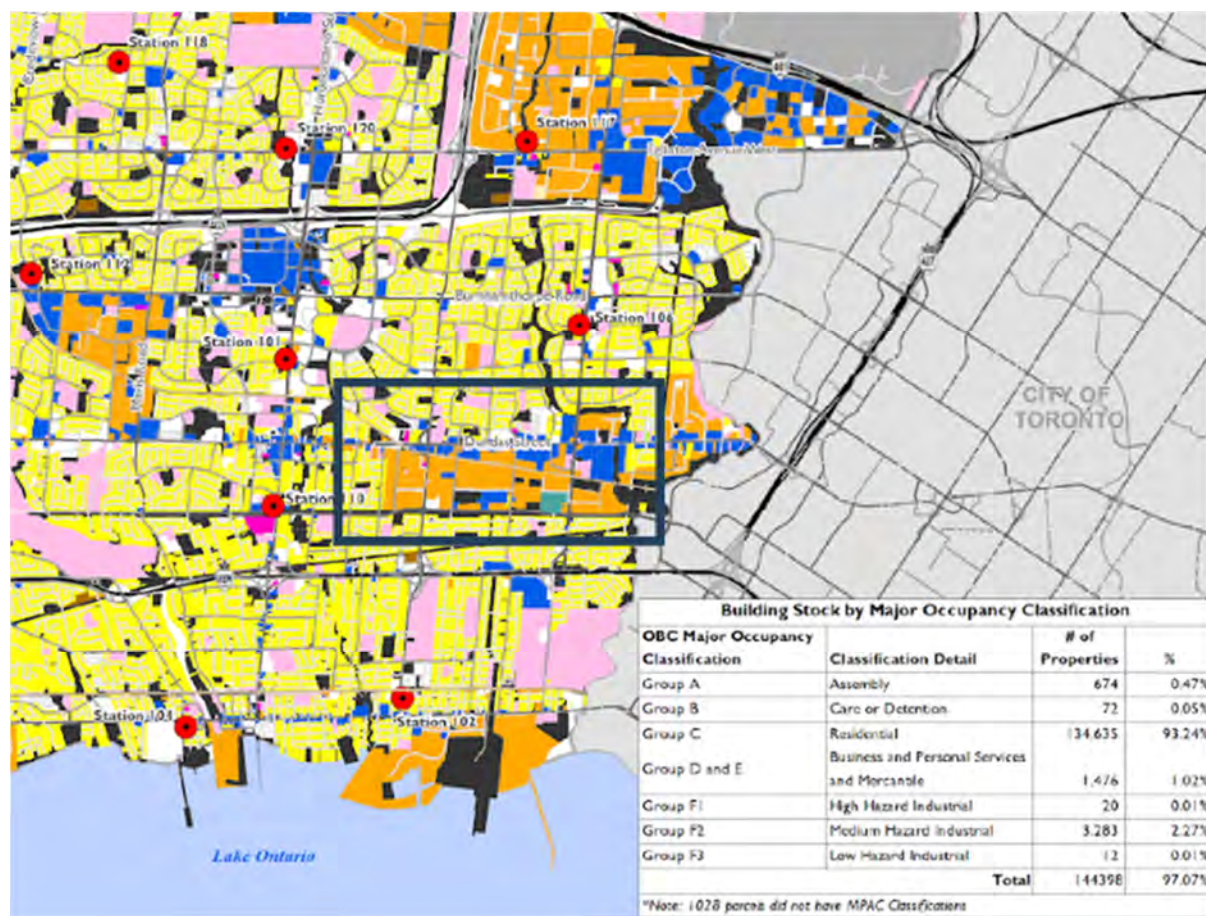

Image 2.4.4: The above building stock map above has been taken from a study that is part of Community Risk Assessment (not a public document); The cluster of medium hazard building to the north of the QEW, are shown in orange and marked with a black rectangular outline.

### 2.4.2 Fire Station Property Search

Mississauga’s current ranking strategy and analysis of existing Fire Services includes the following:

- 17 stations requiring extensive renovations (FS 101, 102, 103, 104, 105, 107, 108, 109, 110, 111, 112, 114, 115, 117, 118, 121, and 122)
- 4 stations in a state of good repair (106, 116, 119, 120)
- 6 new stations (in progress 123, 124, 125) (requiring land 126,127,128).

### Ranking Strategies Geographic Adjacencies

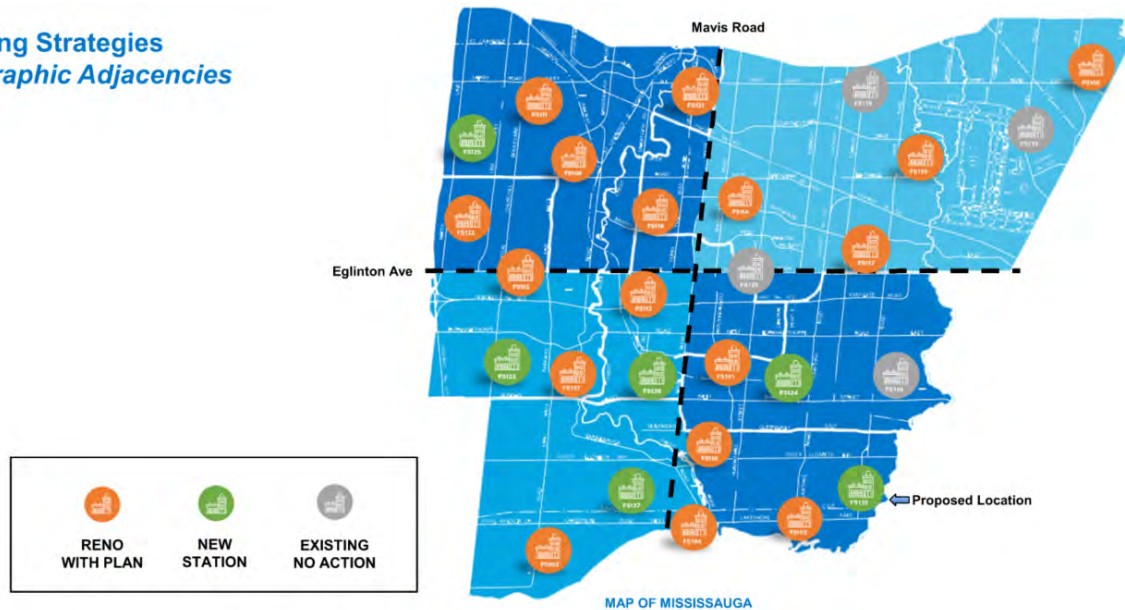

Image 2.4.5: Ranking strategy and analysis of existing Fire Services in Mississauga. Source: Mississauga.

In late 2023 Mississauga Realty Services conducted a Fire Station property search & due diligence review on 9 potential locations for new fire stations. Because this information is considered confidential the property details of this search have not been included in this HIA. Generally, the available property locations are described as follows:

1. Southwest corner of Dixie and Queensway
2. Southeast corner of Dixie and Queensway
3. Cawthra Road North of Bloor
4. Queensway and Greenhurst Avenue
5. North side of Queensway
6. Dixie north of Queensway
7. Northwest corner of Queensway and Dixie.
8. Dixie north of Queensway
9. Dixie south of QEW.

It is important to note that all nine potential locations were north of the QEW and although they would provide service to the Dixie / QEW target area, they would not adequately provide service to the future Employment Lands and the future Lakeview Village Development, in the Lakeview

community to the south. The site of the Lakeview Golf Course is owned by the City of Mississauga, and if it is considered appropriate from a heritage perspective, it could provide a location for a new fire station without considering expropriation of property.

### 2.4.3 Preferred Option for Development

The preferred option for developing the site, called “Option 1” is a layout initially proposed by Mississauga that has been refined during the development of this HIA. This option provides a two-bay Fire Station on the site. The design is based on the standard for a one-storey station that is provided in the City of Mississauga Template Design and Standards for New Fire Stations, but with a small two-storey portion at the apparatus support spaces adjacent to the fire truck bays. This option has been selected as the preferred option primarily because it is the option that best meets the functional requirements for a Fire Station.



*Image 2.4.6: View from in front of the tee, elevated above the ground using drone photography, looking down the fairway of Hole 13, Lakeview Golf Course. The fairway doglegs slightly to the left. The proposed development site is at the right-hand side of the image beyond the fairway rough. From this vantage point the new proposed fire station building would be behind the coniferous tree at the right-hand edge of the image. Image from City of Mississauga video. (<https://www.mississauga.ca/golf/lakeview/>)*

The illustration below (Image 2.4.7) shows the Fire Station and driveway circulation on the left and on the right the Fire Station and driveway circulation are overlaid with an aerial image of the site and

surveyed information, including the location and caliper of trees. This Option can be viewed in larger format in Appendix 6.



Image 2.4.7: Preferred Option I. Source, +VG Architects.

Trees that are identified with a green circle in the site plan will likely be able to be protected during construction, pending the final design layout of the fire station. Further input from an Arborist is recommended during design stages to maximize the retention and protection of existing trees. A tree replanting program is recommended along the edge of the rough that lines the east side of the fairway, in the proximity of the building and the driveway. This is further described in the section called “Preferred Option Mitigation” below.

Interior building layout from the Design Guidelines are not show in the HIA graphics. The plans provided in this HIA are only guidelines, showing a footprint for the building. The final design and internal programming would need to be further be adjusted to the site during the design stages of the fire station.

#### Features of preferred Option 1

The following list provides some of the perceived advantages of the preferred option and rationale as to why it was chosen as the most suitable option for Fire Station 128.

- Parking spaces are set back 6.0m from the property line along Dixie Road, complying with Mississauga’s Template Design and Standards for New Fire Stations

- A 3.0 m landscape buffer is provided along the lot line adjoining the Fairways Condo development
- The footprint of the proposed building is set back 4.3 m from the lot line along Dixie Road. With further investigation of the interior layout of the fire station, this setback could potentially be reduced further providing more protection of the trees behind the building.
- Of the four large trees identified in Section 2.3, two trees each with trunk diameters of 1.0 m are protected.
- Some of the trees lining the rough of the fairway can be protected. With further investigation and input from an arborist during design phases, it is possible that more trees could be protected.
- The compact design proposed provides a reduced building width of approximately 2.0 m when compared with Mississauga's Template Design and Standards for New Fire Stations. This is due to the 2-storey apparatus support spaces adjacent to the fire truck bays (as designed for Fire Station 124 Optional Template Design standard). This design feature creates a larger continuous roof surface at the second storey level which can accommodate an increased number of pf PV panels on the roof.
- The exit driveway accommodates both trucks abreast rather than the single file.
- The generator and waste enclosure are accessible from the paved area on the entry side of the traffic flow.

Negative heritage impact of this option includes:

- Loss of approximately 40 trees whose trunk diameter is at least 0.16 m in diameter measured at approximately 1220 mm above grade.
- Reduction in the physical area of the Lakeview Golf Course property
- This option anticipates the full demolition of the existing greenskeeper's house to allow for construction of the parking lot and the building.

#### Site Boundaries:

The proposed site boundary shown on Option 1 in Appendix 6 includes a 3.0 m setback from the rear wall of FS 128 to the golf course. There is also a 3.0 m side yard setback between the parking spaces on the south side and the existing condo property line, and a 3.0 m setback on the north side between the driveway and the proposed new property line. The total site area of the Option 1 lot is 3,951.39 sq. m (45,532.4 sq. ft or 0.976 acres). Note that the Mississauga Template Design and Standards for New Fire Stations report estimated the site area for a two truck one storey site plan as being 0.9 acres (Page 48).

#### Zoning:

As stated in section 2.3.4.3 of this report, Lakeview Golf Course is currently zoned OS2-1, with a zone description as "City Park" and a zone category as "Open Space." Under OS2-1 Exception Zones the following are permitted uses:

- (1) Golf Course

(2) Recreational Establishment

(3) Groundskeeper Residence

This report recommends rezoning of the Option 1 site from OS2-1 to OS2 to allow the construction of an Essential Emergency Services fire station facility.

The following chart compares OS2 zone regulations required under Table 9.2.1 of Mississauga Zoning By-law 0225-2007 with Option 1.

<b>Zone regulations under Table 9.2.1 of Mississauga Zoning By-law 0225-2007</b>	<b>Required for OS2 Open space – City Park</b>	<b>Provided in Preferred Option 1</b>
Minimum setback of a building or structure to a lot line	4.5 m	3.0 m
Minimum setback of a building or structure to a lot line abutting a residential zone	6.0 m	5.9 m to the waste enclosure 23.4 m to the Fire Station
Minimum landscaped buffer abutting all lot lines	4.5 m	3.0 m

The proposed setbacks and landscape buffer of the preferred Option 1 site do not meet the minimum requirements of Table 9.2.1.

The setback at the rear lot line and the north lot line can be addressed easily if required by changing the position of the proposed lot line to achieve a 4.5m setback. This would increase the area of the fire station site and decrease the area of the golf course. The need for a 4.5 m setback between OS2 and OS2-1 should however be questioned as moving the lot line may not achieve any tangible difference to the golf course. Maintaining the proposed 3.0 m setback at these locations would however be beneficial to Lakeview Golf Course as it would give control over more land adjacent to hole #13.

At the south lot line, where the proposed fire station site abuts the Fairways Condominium site, the proposed site plan does not provide the required 6.0 m setback to the residential zone, and it does not provide the required 4.5 m landscape buffer. If the position of the proposed building, driveways, and parking area, were shifted north 1.5 m north to achieve the required setback and landscape buffer, there would be further negative impact to the golf course with the potential loss of or injury to mature trees. This impact would include the potential loss of the following trees that were identified as being retained in Option 1:

- 0.50 m trunk caliper diameter
- 0.40 m trunk caliper diameter
- 0.40 m trunk caliper diameter
- 0.36 m trunk caliper diameter.



The setbacks and the position of the building, driveways, and parking provided in Option 1 are recommended.

Further discussion is recommended with the Planning and Development department to develop the appropriate strategy for addressing the setback and landscape buffer issues. Further investigation and input from an arborist during design phases is also required.

## 2.5 Architectural Drawings

### 2.5.1 Preferred Option Massing

The following massing studies show the preferred option, “Option 1”. Trees shown in the following three perspective views are existing trees to be retained in the immediate vicinity of the Fire Station.



*Image 2.5.1: Option 1 site massing – view from Dixie Road looking north-west*



Image 2.5.2: Option 1 site massing – view from Dixie Road looking south-west



Image 2.5.3: Option 1 site massing - view from fairway

## 2.5.2 Preferred Option Mitigation

The image below shows a recommended zone of tree replanting for the preferred option, Option 1. This mitigation measure would replace some of the trees lost due to the development. With a careful selection of tree species, the replanting will provide increased visual screening of the two-storey wall of the Fire Station facing towards the fairway. Replanting will reduce the width of the rough on the east side of the fairway for hole number 13, without significant effect on the course's play. Additional tree replanting may be possible between trees retained and the new fire station, depending on the final building design and footprint. Berms could also be considered, although this should only be done with great caution as it would be altering the topography of this designed landscape.



*Image 2.5.4: Recommended zone of tree replanting for Option 1. Annotated image from Google Maps.*

For existing trees to be protected during construction, neither the excavations for the building footprint or the paved parking/driveway can be within the 'dripline' of the canopy.

The following massing studies show the preferred option, "Option 1". Trees shown in the perspective views are existing trees to be retained in the immediate vicinity of the Fire Station, like the images presented in Section 2.5, however, recommended tree replanting along the fairway rough for hole number 13 is also shown.



*Image 2.5.5: Option 1 site massing – view from Dixie Road looking north-west showing tree replanting at edge of the rough. This image can be compared with Image 2.5.1 to understand the impact of the additional trees.*



*Image 2.5.6: Option 1 site massing – view from Dixie Road looking south-west showing tree replanting at edge of the rough. This image can be compared with Image 2.5.2 to understand the impact of the additional trees.*



*Image 2.5.7: Option 1 site massing - view from fairway showing tree replanting at edge of the rough. This image can be compared with Image 2.5.3 to understand the impact of the additional trees.*

## 2.6 Assessment of Alternative Development Options and Mitigation Measures

### 2.6.1 Evaluation for Heritage Impact and Fire Station Functionality

As required by the City of Mississauga’s Terms of Reference for Heritage Impact Assessments, this section presents, evaluates, and assesses potential alternate forms of development. These alternative development options are considered with the goal to avoid or limit negative impact on the cultural heritage resources. In addition to this heritage evaluation and assessment of the different options, the options are also evaluated for their performance in meeting the requirements of a fire station as set out in the City of Mississauga Template Design and Standards for New Fire Stations, and as discussed with City of Mississauga staff during the development of this HIA. Because fire station function inherently includes life safety, issues such as response time are considered paramount in the evaluation. Many of the considered alternate forms of development have been eliminated from being recommended because there would be a negative impact on life safety due to an increase in response time when compared with the template design.

“Response Time: Fire station living areas should be designed to facilitate quick access to the apparatus bays. This should be done by minimizing travel distances to the bays and maintaining a clear path of travel free of obstructions and containing a minimal number of jog and turns.”

*Source: City of Mississauga Template Design and Standards for New Fire Stations page 30.*

### 2.6.2 Mitigation Option: Greenskeeper’s House Relocation

An option for relocating the greenskeeper’s house was investigated previously, and a report documenting the findings of this review was prepared in April 2023 by Shoalts Engineering. A copy of the report is provided in Appendix 7. The conclusion of the report is that although relocating is technically feasible, the railroad to the south, the large number of overhead lines, and the QEW to the north effectively limit the usable distance along Dixie Road for relocating the building “to the length of the golf course itself.”

“The presence of many overhead utilities along Dixie makes moving the house onto the road a challenging and expensive proposition. Relocation on the golf course property would avoid the cost of temporary utility relocation, but this would be practical for only a short move on relatively flat terrain, which essentially means the corridor between the Fairways Condos and the Dixie Outlet Mall property.” (April 2023 by Shoalts Engineering page 1).

Relocation of the unreinforced, brick masonry structure is considered not feasible.

### 2.6.3 Other Sites Locations Elsewhere in Mississauga

As discussed in Section 2.4 of this report, nine other locations were investigated by Mississauga Realty Services as potential locations for a new Fire Station. The investigation included a property search & due diligence review on nine sites. All nine available potential sites were located north of the QEW and although they would provide service to the Dixie / QEW target area, they would not adequately provide service to the future Employment Lands and the future Lakeview Village Development, in the Lakeview community to the south.

### 2.6.4 Mitigation Option 2

The design investigated for this option looked at using the existing greenskeeper's house as part of the new fire station through an adaptive re-use of the structure. It was proposed that the exterior brick walls, ground floor, veranda, and roof of the existing house building be retained and renovated to house fire station program elements like the dormitory or lounge spaces.

This approach was abandoned for functional reasons related to the required or preferred performance of a two-bay single storey fire station as described in the October 2020 City of Mississauga Template Design and Standards for New Fire Stations. The Template Design Standards require the building to be a post-disaster barrier free facility. Post-disaster buildings have heightened requirements for durability, structural integrity, seismic restraint, and lateral pressures at foundation walls. Unreinforced masonry is not permitted. The empirical design method for masonry cannot be used – all masonry must be engineered. Wood framed structures must include special requirements for shear walls and diaphragms. Composite and multi-wythe solid walls must have grouted collar joists and ties.

In addition to the requirements for a post-disaster building, the requirement for barrier free accessibility would mean the introduction of a ramp, stairs, and/or elevator to negotiate the floor elevation difference between the new construction and the existing ground floor elevation of the greenskeeper's house. The ground floor of the house is approximately four feet above the surrounding grade, and the new fire station would be constructed as a slab on grade. The resulting ramp would need to be 48 feet in length with a mid-landing to meet minimum OBC requirements. There is a strong preference to not introduce ramps, stairs, or elevators in the path of response to the fire truck in a single storey fire station as this can slow or impede response. The additional cost is also a limiting consideration.

After consideration of the requirements and the conditions of the existing building, Option 2 was deemed non-viable.



### 2.6.5 Mitigation Option 3

The design investigated for this option looked at locating the fire station at an alternate location on the site, southeast of the Fairways Condo development. Challenges with this location included interference of either the entrance or exit driveway with the main entrance driveway of the Toronto Golf Course on the other side of Dixie Road, thereby leading to the possible introduction of a new controlled (signaled) intersection on Dixie Road.



*Image 2.6.1: Aerial view of the proposed site for Option 3. The approximate boundary of the site is shown with a yellow dashed line.*

Review and evaluation of this location determined that constructing the fire station on this site would have a greater effect on the golf course's landscape than the preferred option (Option 1). This is due to the perceived significant impact on holes 11 and 12, as well as impact along Dixie Road. Constructing the fire station on this site would lead to the loss of a mature stand of 63 coniferous and deciduous trees at the centre of this site each with a trunk caliper (diameter) of 0.16 m or greater. This stand of trees and the trees that lines the rough along the side of hole number 12 provide a prominent backdrop at the green of hole number 11 as can be seen in the image below (Image 2.6.2). The stand of trees is also the focus of view for the length of fairway number 11 as you approach the green. By comparison, the site for the preferred option, Option 1, is partially concealed behind the existing parking structure for the Fairways Condo development and is not in the direct line of sight looking down a fairway. Trees would also be lost where a new driveway entrance and a new driveway exit would be introduced along Dixie Road.



*Image 2.6.2: Green of Hole 11 with the Option 3 site in the background.*

Although not specifically a heritage consideration, another drawback to this site is its proximity to the southern residential condo tower of the Fairways Condo development, with noise, activity, and lights from fire trucks likely being a concern for many residents. The site for the preferred option, Option 1, is farther away from either of the condo towers.

Through evaluation and comparison of this site to the preferred site (Option 1), the site south of the Fairways Condo development was deemed to have a greater negative heritage impact on the golf course.

### 2.6.6 Recommendation

Having evaluated and assessed the above potential alternate forms of development for negative heritage impact on the heritage cultural landscape, and balancing heritage protection with required life safety design strategies of fire stations, we have concluded that the best option to proceed with is Option 1.

In addition to the options discussed above, several other options were also examined to ensure due diligence. For these additional options, refer to Appendix 8

Option 1 provides the best protection of critical elements of the heritage cultural landscape such as view corridors and landscape elements such as trees, while also providing the best functional layout for the fire station.

## 2.7 Summary of Conservation Principles

### 2.7.1 Definitions

The following definitions apply to Conservation Scope for the Protection of Heritage Attributes at the Lakeview Golf Course:

Fenestration:	The arrangement of windows in a building, including the mullion patterns of the windows.
Reinstate:	To put back.
Replicate:	To make a replica with new material, from historical evidence and/or existing site information.
Restore:	To bring back to a known original state in sound and whole condition by repairing missing elements without changing the design.
Retain:	To keep in place.
Cultural Landscape:	A setting which has enhanced a community's vibrancy, aesthetic quality, distinctiveness, sense of history or sense of place. *
Cultural Feature:	Visually distinctive objects and unique places within a cultural landscape (They are not necessarily consistent with their immediate natural surroundings, adjacent landscape, adjacent buildings or structures. These features can include objects, paths, trees, woodlands, viewpoints and may include features such as rail lines, historic highways, and airports.) *

\*Based on City of Mississauga Inventory of cultural landscapes

### 2.7.2 Conservation Standards

The evaluation of the proposed development and mitigation options in this HIA were undertaken following the heritage conservation principles set out in the second edition of the *Standards and Guidelines for the Conservation of Historic Places in Canada (SG)* published by Parks Canada, and the *Eight guiding principles in the Conservation of Built Historic Properties*, published by the Ontario Ministry of Culture.

The General Standards for Preservation, Rehabilitation and Restoration provided in the Standards and Guidelines include the following standards that apply to all projects:

1. Conserve the *heritage value* of an *historic place*. Do not remove, replace or substantially alter its intact or repairable *character-defining elements*. Do not move a part of an historic place if its current location is a *character-defining element*.
2. Conserve changes to an *historic place* that, over time, have become *character-defining elements* in their own right.
3. Conserve *heritage value* by adopting an approach calling for *minimal intervention*.
4. Recognize each *historic place* as a physical record of its time, place and use. Do not create a false sense of historical development by adding elements from other historic places or other properties, or by combining features of the same property that never coexisted.
5. Find a use for an *historic place* that requires minimal or no change to its *character-defining elements*.
6. Protect and, if necessary, stabilize an *historic place* until any subsequent *intervention* is undertaken. Protect and preserve archaeological resources in place. Where there is potential for disturbing archaeological resources, take mitigation measures to limit damage and loss of information.
7. Evaluate the existing condition of *character-defining elements* to determine the appropriate *intervention* needed. Use the gentlest means possible for any *intervention*. Respect *heritage value* when undertaking an *intervention*.
8. Maintain *character-defining elements* on an ongoing basis. Repair *character-defining elements* by reinforcing their materials using recognized conservation methods. Replace in kind any extensively deteriorated or missing parts of *character-defining elements*, where there are surviving prototypes.
9. Make any *intervention* needed to preserve *character-defining elements* physically and visually compatible with the *historic place* and identifiable on close inspection. Document any intervention for future reference.

The General Standards provided in the Standards and Guidelines include following the standards that apply to Rehabilitation projects. These standards would be applicable if the existing greenskeeper's *house* were integrated into the Fire Station as an adaptive reuse project.

10. Repair rather than replace *character-defining elements*. Where *character-defining elements* are too severely deteriorated to repair, and where sufficient physical evidence exists, replace them with new elements that match the forms, materials and detailing of sound versions of the same elements. Where there is insufficient physical evidence, make the form, material and detailing of the new elements compatible with the character of the *historic place*.
11. Conserve the *heritage value* and *character-defining elements* when creating any new additions to an *historic place* or any related new construction. Make the new work physically and visually compatible with, subordinate to and distinguishable from the historic place.
12. Create any new additions or related new construction so that the essential form and integrity of an historic place will not be impaired if the new work is removed in the future.

The *Eight guiding principles in the Conservation of Built Historic Properties* (See: <https://www.ontario.ca/page/eight-guiding-principles-conservation-built-heritage-properties#section-1>).

1) Respect for documentary evidence

Do not base restoration on conjecture. Conservation work should be based on historic documentation such as historic photographs, drawings and physical evidence.

2) Respect for the original location

Do not move buildings unless there is no other means to save them. Site is an integral component of a building or structure. Change in site diminishes cultural heritage value considerably.

3) Respect for historical material

Repair/conservate rather than replace building materials and finishes except where absolutely necessary. Minimal intervention maintains the heritage content of the built resource.

4) Respect for original fabric

Repair with like materials. Repair to return the resource to its prior condition, without altering its integrity.

5) Respect for the building's history

Do not restore to one period at the expense of another period. Do not destroy later additions to a building or structure solely to restore to a single time period.

6) Reversibility

Alterations should be able to be returned to original conditions. This conserves earlier building design and technique. For instance, when a new door opening is put into a stone wall, the original stones are numbered, removed and stored, allowing for future restoration.

7) Legibility

New work should be distinguished from old. Buildings or structures should be recognized as products of their own time, and new additions should not blur the distinction between old and new.

8) Maintenance

With continuous care, future restoration will not be necessary. With regular upkeep, major conservation projects and their high costs can be avoided.

## 2.8 Proposed Demolition/Alterations

### 2.8.1 Impact Summary Chart

The following is a summary chart considering proposed demolition / alteration of the heritage resource, the impact on the cultural heritage value interests in the site, and mitigation strategies to be adopted.

Proposed Demolition/Alteration:	Impact on cultural heritage value interests in the site and the impact on the streetscape and sense of place:	Mitigation strategy:
Removal of the greenskeeper's house	Loss of original heritage fabric	Symbolic conservation and heritage interpretative signage. Conservation plan for the golf course. The existing greenskeepers house is to be fully documented in detailed measured drawings and photographs. Additional documentation of the demolition process is to be provided by a heritage conservation professional.
New fire station building	Introduction of a new use within the golf course	Expanding infrastructure to support population growth in the area is a safety requirement
Expanding parking / driveway area	Impact on vegetation	Tree protection and arborist recommendations to minimize impact on vegetation
Visual criteria – from the street	New more dominant profile viewed from Dixie Road	View from street currently obscured by intrusive vegetation that will be removed
Visual criteria – within the golf course	New development partially visible	New trees will be planted to replace any loss of existing trees to recreate similar vistas
Operation of the golf course	Minor impact to the player's experience on hole number 13	
Noise/Lights	Light emitted from new building and noise from fire trucks	Use IESNA full cutoff lighting

## 2.8.2 Assessment of Preferred Option based on the Parks Canada Standards and Guidelines for the Conservation of Historic Places in Canada

### Parks Canada Standards and Guidelines:

The proposed intervention for development of the site described in Section 2.4 of this report is in line with the recommendations of Parks Canada Standards and Guidelines for the Conservation of Historic Places. The golf course property can best be described as an example of a “designed landscape”, which is a subcategory within the broader context of a cultural landscape (Standard and Guidelines for the Conservation of Historic Places, p. 48).

The value of the property can be attributed to:

- 4.1.1 Evidence of land use: an early 20<sup>th</sup> century example of usage of land for the purpose of recreation
- 4.1.4 Spatial organization: the movement through the course, and positioning of the holes and fairways within a constricted layout
- 4.1.5 Visual Relationships: the vistas through the golf course
- 4.1.8 Vegetation: mature trees, most of which were planted at the time the golf course was initially designed
- 4.1.9 Landforms: manmade and natural: human made landforms pertain to landscape features (fairways, sandtraps, etc.) related to the original design of golf course;
- 4.1.10 Water features: Applewood creek
- 4.1.11 Built features: the greenskeeper’s house as an example of early residence meant to be used by the groundskeeper

The conservation approach best suitable for this property falls within “Additions or Alterations to a Cultural Landscape” listed as number 12, under Additional Guidelines for Rehabilitation Projects. According to the guideline: “Designing a new feature when required by a new use:

- is to be compatible with the past or continuing land use
- that does not obscure, damage or destroy character defining land patterns
- that is compatible with the character-defining spatial organization (4.1.4)
- that respects the historic visual relationships in the cultural landscape
- is to be compatible with the heritage value of the cultural landscape.

## 2.9 Alternatives for Salvage Mitigation

As it has been demonstrated in the Assessment of Alternative Development Options and Mitigative Measures (Section 2.6), the greenskeeper's house cannot be retained while meeting the functional design requirements of a new fire station. A new fire station is needed to serve the Dixie / QEW area and to support the growth of population in Lakeview.

The Ontario Places to Grow Act, (2005) enables the development of regional growth plans that guide government investments and land use planning policies. According to Mississauga's growth forecast, Mississauga's population will grow from 723,000 persons in 2008 to 812,000 persons in 2031, (source: Mississauga Growth Forecast Population 2008-203), and is projected to be 930,800 persons in 2051 (source: City of Mississauga Long-Range Forecasts 2011-2051 (2013), City of Mississauga Planning and Building Department and Statistics Canada Census data). As described in Section 2.4.1, the Lakeview Village Development Master Plan (2019), provides for a portion of this significant population increase over a period of 10 to 20 years.

Consideration of alternative design options was provided to minimize impact on the greenskeepers' house. Other options including the relocation of the house, and survey of Mississauga for alternative locations where a fire station could be built, were also considered as discussed under Section 2.6. These options proved to be either unviable, or in some cases more harmful to the other significant attributes that are the basis of the golf course's designation as a cultural landscape and designated heritage property.

Having completed this review, +VG Architects' recommendation is to preserve the greenskeeper's house in a symbolic way. The following design strategies can be considered as ways in which the house can be symbolically preserved and commemorated:

- Use of salvaged bricks to incorporate landscape element(s) that will help to commemorate the former position of the greenskeeper's house
- Retain a portion of the brick foundation wall, or alternatively retain the brick piers of the verandah and incorporate into a paved landscape area with seating and pergola
- Commemorative plaque with historical images and information on the history of the golf course and the greenskeeper's house
- Apply a different paving treatment where the greenskeeper's house is located.



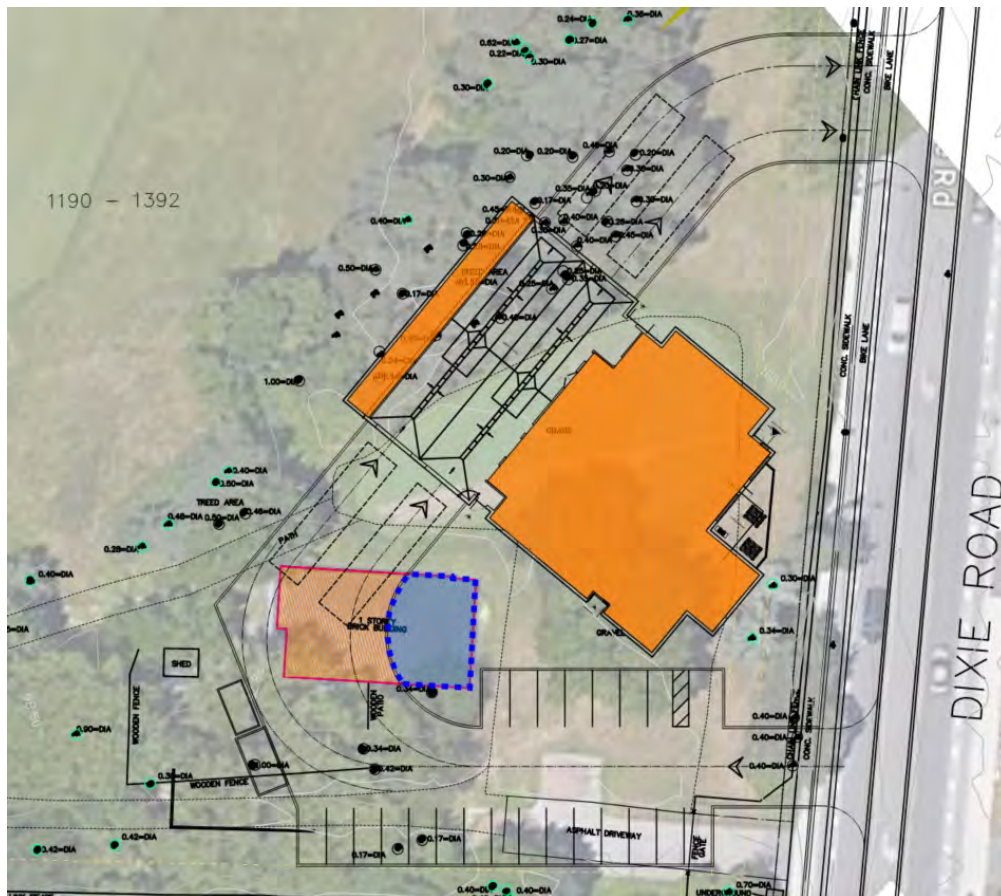

*Image 2.9.1: Footprint of the greenskeeper's house demarcated in a different paving treatment. This paving treatment is proposed for the landscape area bounded by the curb of the entrance driveway as indicated by the blue dashed line. Consideration for extending the demarcation of the former footprint into the driving aisle should be reviewed by Mississauga Fire and Emergency Services.*

The options above should be examined in the format of an iterative process involving the design team to be selected to tackle the next phase of the development. The actual design of the symbolic conservation needs to be developed in conjunction with the design of the new fire station. A heritage professional shall be involved to review and provide comments as the project advances to detailed design.

## 3.0 Summary Statement and Conservation Recommendations

### 3.1 The Significance and Heritage Attributes of the Cultural Heritage Resource

- The golf course design as a rare surviving example of a traditional tree-lined parkland layout golf course in an urban setting, designed by golf course architect Hebert Strong
- Contextually, the location, orientation and dimensions of the golf course and proximities to its urban context
- The placement and orientation of the original tees, layout of the holes, fairways, greens, bunkers and other hazards, natural or otherwise, on varying topographical features
- The shape and form of the greens, trees and other vegetation and their/its placement
- Historically a site of important golf tournaments
- The greenskeeper's house at 1392 Dixie Road, with its broad gently pitched roof that covers the veranda; chimney; Edwardian elements, including a Classical pediment, the short colonettes, with their decorative mouldings, on brick piers that support the veranda roof, the veranda balustrade, the fenestration, including the bay windows and sidelights flanking the main entrance, and wood siding.

### 3.2 Summary of the Impact of Proposed Development on the Cultural Heritage Resource

- Loss of trees and vegetation
- Loss of the greenskeeper's house
- Introduction of a new use within the golf course parcel of land

### 3.3 Summary of recommended mitigative measures and approaches

- Use of tree protection and special procedures to be specified by an arborist to minimize harm to trees and vegetation
- Preferred option is the least intrusive approach impacting the layout of the golf course and location of the tees
- Tree replanting campaign
- Develop a Heritage Conservation Plan for the Lakeview Golf Course
- Documentation of the greenskeeper's house including drawings and photographs and preserving as part of an archive. The drawings can be included as part of the commemorative plaque.

Five alternative design options, relocation and possibilities for other locations where the fire station could be relocated, were examined and found to be not viable, as described under Section 2.6 and Appendix 8.

## 4.0 Mandatory Recommendation

Lakeview Golf Course is designated under Part IV of the Ontario Heritage Act (following Regulation 9/06). An evaluation of the heritage value of the Lakeview Golf Course was previously conducted in 2007, based on the three categories of O. Reg 9/06: Design/Physical, Historical/Associative, and contextual value. The property met criteria under all three categories.

The main attributes that contributed to the designation of the golf course can broadly be noted as:

- a) the golf course landscape design features (layout and location of tees and fairways);
- b) historical importance attached to the identity of the golf course architect (Herbert Strong) and historical values associated with the important golf tournaments that took place, and
- c) the contextual relationship between the golf course and its urban setting.

The golf course is also included on the City of Mississauga's Cultural Landscape Inventory. In the designation statement, the greenskeeper's house is noted as one of the features within the golf course that contributes to the designation of the property (the house is a heritage attribute of the golf course).

In November 2022, the Government of Ontario passed Bill 23, More Homes Built Faster Act. The Act included changes to O. Reg. 9/06 Criteria for Determining Cultural Heritage Value or Interest to establish that a property must meet two or more criteria in the regulation to be designated.

The criteria, s. 27 (3) (b), set out in Ontario Regulation 9/06 of the Ontario Heritage Act, are as follows:

1. The property has design value or physical value because it is a rare, unique, representative or early example of a style, type, expression, material or construction method.
2. The property has design value or physical value because it displays a high degree of craftsmanship or artistic merit.
3. The property has design value or physical value because it demonstrates a high degree of technical or scientific achievement.
4. The property has historical value or associative value because it has direct associations with a theme, event, belief, person, activity, organization or institution that is significant to a community.
5. The property has historical value or associative value because it yields, or has the potential to yield, information that contributes to an understanding of a community or culture.
6. The property has historical value or associative value because it demonstrates or reflects the work or ideas of an architect, artist, builder, designer or theorist who is significant to a community.

7. The property has contextual value because it is important in defining, maintaining or supporting the character of an area.
8. The property has contextual value because it is physically, functionally, visually or historically linked to its surroundings.
9. The property has contextual value because it is a landmark.

As with the 2007 evaluation of the Lakeview Golf Course, an evaluation of the golf course today would indicate that more than two of these criteria are met.

## 5.0 Statement of Professional Qualifications

This report is based on the latest available information and documentation provided by the City of Mississauga from December 2023 to May 2024.

*This Heritage Impact Assessment Report has been Prepared by:*

**+VG Architects** (Toronto) Ltd.  
52 Scarsdale Road, Suite 212  
Toronto, Ontario  
M3B 2R7

Authored by:

**David Ecclestone**, B.E.S., M. Arch., O.A.A., M.R.A.I.C., CAHP

Co-authored and edited by:

**Arash Yousefi**, B. Arch; M Sc. (Arch)

In the preparation of this report David Ecclestone and Arash Yousefi have conformed with accepted technical and ethical standards including the CAHP Code of Conduct for architectural heritage conservation in Ontario, Canada. The report has been prepared in accordance with the *Parks Canada - Standards and Guidelines for the Conservation of Historic Places in Canada*, the Ontario Ministry of Culture's *Eight Guiding Principles in the Conservation of Historic Properties* and following the City of Mississauga's Terms of Reference for Heritage Impact Assessments. The information included in the HIA is accurate and reflects our professional opinion.



**David Ecclestone**, B.E.S., M. Arch., O.A.A., M.R.A.I.C., CAHP

## Appendices:

### Appendix 1:

- Proposed Heritage Designation Lakeview Golf Course, 1190 Dixie Road (Ward 1), March 16, 2007

### Appendix 2:

- Designation Statement for Lakeview Golf Course

### Appendix 3:

- Topographic Survey: 2023-11-09 - 1190 Dixie Road FS128 - Office Topo
- Topographic Survey including tree trunk caliper: 2024-03-19 - 1190 Dixie Road FS128 - Office Topo North Side

### Appendix 4:

- Excerpt: Cultural Landscape Inventory: City of Mississauga, January 2005 (see pdf page 83)

### Appendix 5:

- City of Mississauga's Template Design and Standards for New Fire Stations (October 2020 version)

### Appendix 6:

- Preferred Option I – Site Plan Drawing

### Appendix 7:

- Shoalts Engineering report: Proposed Relocation of Lakeview Golf Club Cottage Apr26, 2023

### Appendix 8:

- Alternate Site Options 4a, 4b, 5A and 5b

### Appendix 9:

- Chain of Title Report, Parcel Register, and Property Index Map

# Appendix 1

Proposed Heritage Designation Lakeview Golf Course, 1190 Dixie Road (Ward 1), March 16, 2007





# Corporate Report

Clerk's Files

Originator's  
Files

HAC

---

**DATE:** March 16, 2007

**TO:** Heritage Advisory Committee  
Meeting Date: March 27, 2007

**FROM:** Paul A. Mitcham, P.Eng, MBA  
Commissioner of Community Services

**SUBJECT:** **Proposed Heritage Designation  
Lakeview Golf Course, 1190 Dixie Road  
(Ward 1)**

---

**RECOMMENDATION:** That Lakeview Golf Course, 1190 Dixie Road, be designated under Part IV of the *Ontario Heritage Act* for its historical, design and contextual value and that the appropriate City officials be authorized and directed to take the necessary action to give effect thereto.

**BACKGROUND:** The City of Mississauga listed Lakeview Golf Course on the Heritage Register in 2005 as a cultural landscape. The City noted the property not only because it is a significant green space within an urban setting, but also because of its association with the history of golf and its contribution to Lakeview's sporting and social history. The course was established at its current site in 1907. It is one of the earliest professionally-designed golf courses in Canada. Although the course began as a private golf club, it became public in 1957 when Toronto Township took over the operation of the club and eventually ownership in 1965. Lakeview Golf Course has a long history, which has not only contributed to the story of golf in Canada, but to the local history of Mississauga. See Appendix 1 for a full report.

**COMMENTS:** The City's Mississauga Plan, Section 3.17.1.2b, states, "... heritage resources of significant value will be identified, protected, and preserved." The Plan further states, under Section 3.17.2.6, that "heritage resources must be maintained in a manner that prevents deterioration and protects the heritage qualities of the resource." As the City is the owner and protector of Lakeview Golf Course, it is a matter of stewardship that the City provides designation to both protect and conserve this heritage resource.

The *Ontario Regulation 9/06*, the *Ontario Heritage Act*, prescribes the criteria for determining a property's cultural heritage value or interest. The values outlined below show that Lakeview Golf Course meets these criteria.

**HISTORICAL VALUE:** The property has a longstanding history of golf in Canada. Its historical value is associated with the history of golf tournaments, including the Canadian Open and the initiation of the Ontario Open, Ontario Amateur Open and Champion of Champions Tournament. It is also associated with the players and winners of these. The course is associated with local golf history, as well as Mississauga's history as a place of recreation for residents of York (now Toronto). Lakeview Golf Course demonstrates the ideas of Herbert Strong, a world-renowned golf course architect, and the work of Thompson Cumming and Thompson, an important Canadian designer and constructor of golf courses.

**DESIGN VALUE:** Lakeview Golf Course has design value because it is one of few remaining examples of a tree-lined parkland golf course layout in an urban setting. It is a rare surviving and representative example of a Herbert Strong designed course of the early twentieth century. It displays a high degree of craftsmanship and artistic merit according to golf enthusiasts.

**CONTEXTUAL VALUE:** The property is a large landmark that defines and maintains Lakeview's golf course landscape. It is physically, functionally and historically linked to the community, from which it took its name and the Grand Trunk (now Canadian National) Railway tracks that are part of both its formative history and history as a destination for York residents. It is physically and historically linked to the Toronto Golf Club.

**FINANCIAL IMPACT:** No impact.

**CONCLUSION:** Lakeview Golf Course is one of few remaining traditional parkland golf courses in an urban setting. It is also one of few remaining Herbert Strong designed courses. Strong is a notable golf course architect and green artist. The Course is also of historical note for the important tournaments and players that it hosted. The property is integral to Mississauga's history as a recreation destination for York residents. For the values outlined herein, Lakeview Golf Course should be designated under the *Ontario Heritage Act*.

**ATTACHMENTS:** Appendix 1: Full Designation Report

---

Paul A. Mitcham, P.Eng, MBA  
Commissioner of Community Services

*Prepared By: Mark Warrack, Heritage Coordinator*

Appendix 1



LOCATION MAP - 1190 Dixie Road



## Appendix 1

**HISTORICAL BACKGROUND**

Lakeview Golf Course is the product of urban encroachment in York (Toronto). Shortly into the twentieth century development drove many of York's golf courses to the periphery. In the case of Lakeview, a Swansea Township bolt factory's housing needs, in and around High Park, was the push. Lakeview Golf Course was originally High Park Golf Club, the country's tenth oldest. It was established in 1896 on a modest fifty acres on the west bank of Grenadier Pond. In 1907 the Club received its eviction notice and sought another site. Three were considered. The current location of Lakeview Golf Course was selected. Some of the members chose instead to help establish the Mississauga Golf & Country Club. Evicted from its original Lambton site, the Mississauga Club was establishing its current location on Mississauga Road, north of the Queen Elizabeth Way.

Lakeview Golf Course originally comprised the south half of lot 6 concession 2 south of Dundas Street. This had been the Reuben Dunn Farm. The Grand Trunk Railway tracks bisected the property. The Club viewed the tracks, water courses and lines of trees as favourable natural hazards. Rosedale Golf Club Professional W.J. Lock also deemed the sand soil of "great advantage." Lock designed the new course. Nine holes were completed below the tracks in 1907 with the remaining above the tracks in 1908. According to an article published in *Outdoor Canada*, in 1907, the ninth hole was 750 yards long. It was purported to be the country's longest. An architect by the name of Townsend converted the Dunn farmhouse into a clubhouse.

The tracks must have become an undesirable hazard as four years later the Club sold the southern land and purchased forty acres at the north end of the course. This had been the Death farm. However, a small parcel of it was reserved for Leslie Pallett. (A substantive house stands on this property at 1400 Dixie Road.) A new thirty room clubhouse was built. The former one was sold with the southern part of the property. It later became the Pinecroft Inn. At this time also, the Board of Directors decided to rename the club "Lakeview," for the community that it inhabited. The Board launched the new name the following year, in 1912.

Despite the fact that the club finally chose a name more reflective of its locale, its clientele still mostly hailed from High Park and other areas of York. Even in 1934, William Perkins Bull remarked that 25 of the Club's 475 members were Peel residents. Initially golfers travelled to Lakeview by streetcar from Sunnyside. After the Toronto Golf Club moved next door, to the east, and its course was ready – fall 1912 – the Grand Trunk Railway erected a small "Golf Links" station at the courses. Founded in 1876, the Toronto Golf Club had been located at Fernhill. The Railway removed the station in 1931 when automobiles were thought to make it unnecessary. It is important to note that these clubs were resorts. Members and their guests stayed for many days.

Lakeview Golf Club's first major tournament was the Canadian Professional Golf Association Championship in 1914. Toronto Golf Club Professional George Cumming won. During World War I, the club answered a government call for produce, as did many golf courses at the time. The Club grew vegetables and hay on its property. The entire eighteenth fairway served as a vegetable garden. After the war, commencing in 1920, Thompson Cumming and Thompson began making improvements to the course. Thompson Cumming and Thompson was a prominent Canadian golf construction and design firm, headed up by Stanley Thompson.

In 1921 Club President Frederick A.N. Powell commissioned New York golf architect Herbert Bertram Strong to design a \$35000 championship layout. Strong was an Englishman born in Ramsgate, Kent. He immigrated to New York in 1905 but had previously served as professional

## Appendix 1

and club maker at St. George's, Sandwich. It is important to note that this course, designed by Laidlaw Purves, was known for its wild and rugged layout.

Strong's initial years in the United States were spent as professional at Apawamis Club in Rye. In 1911 he began work at Inwood Golf Club in Far Rockaway. While serving as pro he redesigned and rebuilt the course. This led to other design work and ultimately a career in the relatively new field of golf course architecture. He went on to design many courses in North America, including the Canterbury Country Club, Cleveland; Metropolis Golf Club, New York; Ponte Vedra Golf Club, Florida; Club Laval Sur Le Lac, Montreal; Manoir Richelieu, Quebec; and one in Cuba.

Thompson Cumming and Thompson completed the construction of Strong's design in 1922. It was widely hailed as one of the country's most challenging courses. It instantly became an important course on the tournament circuit. In 1923 alone the course hosted the Canadian Open and the first Ontario Open and Ontario Amateur Open. These were won by Clarence W. Hackney, Andy Kay and R.M. Gray respectively. According to enthusiasts in the field, it is "extraordinary" for a course to host major championships so soon after being constructed. In the fall of 1923 the Club purchased an extra strip of land on the west, as per Strong's recommendation. It allowed for additional space between the 5<sup>th</sup>, 6<sup>th</sup> and 7<sup>th</sup> holes.

Hundreds of North America's top golfers played the course. However, the 70 par eluded them all until 1934 when the Canadian Open returned to Lakeview. Ky Laffoon broke par with 68 in the first round and Leo Diegel subsequently scored even lower with 65. Tommy Armour won the tournament. In the 1990s course manager Wally Jones moved the seventh tee, increasing par to 71.

Lakeview Golf Club enjoyed many years of great success. To avoid overcrowding, it limited membership to 500. The course averaged 10,000 guests each season. However, these numbers dropped off during the Depression. Consequently when fire consumed the clubhouse in July 1939, without insurance, the Club was on the brink of financial ruin.

Harry Phelan and Bill Purtle saved the day. They purchased the course in 1940 for \$400,000, built a new clubhouse, and ran the club semi-privately. Because Phelan enjoyed playing shirtless, he initiated a ban on women at that time. It is interesting to note that Phelan died of a heart attack on the thirteenth hole in 1945. During this semi-private tenure Purtle initiated the first Champion of Champions tournament in 1946. The format was so popular that the Ontario Golf Association picked it up in 1963.

In 1957 Toronto Township took over operation of the course, under a lease. The Township made it public and not only allowed them back, but encouraged women to golf at the course. The new management even installed a playground for children. Larry Edwards was hired as pro at this time; he retired in 1985. The municipality took ownership in 1965. Since 1957 the course has been pay-as-you-play. Very few courses in Canada have such a rich tournament history:

1914 – C.P.G.A. Championship	1929 – Ontario Open Championship
1923 – 1 <sup>st</sup> Ontario Open Championship	1933 - Ontario Amateur Championship
1923 – 1 <sup>st</sup> Ontario Amateur Championship	1934 – Canadian Open Championship
1923 – Canadian Open Championship	1946 – 1 <sup>st</sup> Ontario Champions of Champions
1924 – Ontario Junior Championship	1971 – Ontario Public Course Championship
1928 – Ontario Amateur Championship	

## Appendix 1

**PHYSICAL DESCRIPTION**

Lakeview Golf Course comprises a narrow rectangular tract with an extra strip of land on the west and excluding a parcel on the east. The course slopes south towards Lake Ontario, though it appears flat. Applewood Creek meanders through the property on a north-south axis. There is also a substantial hill at the southeast corner.

Strong capitalized on these natural features when designing Lakeview Golf Course. Working in an age when landscape architecture relied on horse and mule rather than bulldozer, this was common. However, Strong utilized the natural features to create challenge. He placed most of his large greens at or near dramatic ridgelines associated with the creek, buried tributaries or hills.

Moreover, he carefully sculpted and formed these greens in accordance with the subtle nuances of each hole. Strong has been dubbed a “green artist.” Lakeview’s greens have been likened to snooker tables. Strong construed each green to emphasize strategy. One technique he often used to produce this affect was to design the greens and fairways so that they would form doglegs or simply undulate. Some fairways produced blind shots, which are rare.

In addition to natural hazards, including the creek, topographic undulations and vegetation, Strong constructed hazards. These include sand traps and water features, though the large pond was added later for irrigation purposes. Strong’s bunkers are large, deep and subtly hidden.

All of the challenges make up for the length of the course. It is 6263 yards long. The majority of the holes are between 350 and 475 yards. The first nine holes are in the south-western half with the last nine holes in the northeast. Likely owing to the tight space, many of the fairways mimic the north-south axis of the compressed parcel of land.

Because the fairways are so close together, the tree lines are important. They serve to not only separate the fairways but also protect golfers from errant balls. The trees are lush and vary in variety. The course represents a traditional tree-lined parkland layout. The placement, orientation and form of the tree lines, greens, fairways, sand traps and the original water features and tees all contribute to Strong’s carefully designed course. These elements should all be preserved.

As well as the adjustment made to the seventh tee and the addition of the pond, there have been some minor alterations to Strong’s design of Lakeview Golf Course. The first and 11<sup>th</sup> tees were pushed forward to accommodate the starter’s booth and to cater to public golfers respectively. The 18<sup>th</sup> tee was moved southwards for safety reasons, and to accommodate the pond. A second tee and green were installed on the 17<sup>th</sup> fairway, on a north-south axis near the river, to relieve pressure on the original tee deck. Several adjustments were made to the 4<sup>th</sup> hole to minimize errant balls from being sliced off the property. The City adjusted the angle of the tee box and fairway inwards, installed a sixteen high foot fence, a pond and a large sand trap to catch westward balls.

There are several structures on the property. These include a new clubhouse and a cart shed at the south end, a maintenance facility, at the north end of the parking lot, and the superintendent’s residence, at 1392 Dixie Road, at the northeast corner of the property. The dwelling faces onto Dixie Road and is accessed by its own driveway. An inconspicuous laneway from Dixie provides access to the course.

## Appendix 1

The superintendent's residence was built in 1914 for the course's golf pro, Alfred Russell. It is an Edwardian style bungalow. A large simplified roof dominates the simple structure. A tall chimney and a Classical pediment disrupt the roof line. Short colonettes and brick piers support the extended eaves. A pattern of three raised vertical lines, the middle one longer than the outer two, enhance the street face of each colonette. They anchor a generous veranda, enclosed by balustrades, accessed by six steps. Sidelights enhance the entryway. Bay windows flank it. Additional fenestration exists on the other faces. Horizontal siding currently sheathes the structure.

### **CONTEXTUAL DESCRIPTION**

Lakeview Golf Course physically comprises a large central segment of the community for which it is named. It and the Toronto Golf Club, to the east, form a substantive single-use green landscape in the southeast corner of Mississauga. Vast green space is important within an urban environment, especially amidst development and intensification. The railway tracks remain at the south end of both courses. Dixie Value Mall now abuts the Lakeview Golf Course at the north, with housing to both the south and west. Though the course originally catered to York residents, for many years now it has served the local community.



Appendix 1



Aerial Map – 1190 Dixie Road

Date of Aerial Photo: May 2006



Produced by  
T&W, Geomatics

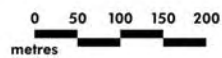

January 2007

## Appendix 1

## IMAGES



Aerial photo of Lakeview Golf Course. Provided by Dan Trout.



Hole 1, Lakeview Golf Course, 2006. Photo: Peter Mancuso.

## Appendix 1



Hole 10, Lakeview Golf Course, 2006. Photo: Peter Mancuso.



Hole 16, Lakeview Golf Course, 2006. Photo: Peter Mancuso.

Appendix 1



Historical Plaque, Lakeview Golf Course, 2006.



Superintendent's Residence, Lakeview Golf Course, 2006.

## Appendix 1

**SOURCES**

Bull, William Perkins. **From rattlesnake hunt to hockey : the history of sports in Canada and the sportsmen of Peel, 1798 to 1934.** Toronto: The Perkins Bull Foundation, 1934.

**Canadian Golfer.** Access provided by Canadian Golf Hall of Fame and Museum.

Cornish, Geoffrey S. & Ronald E. Whitten. **The Architects of Golf.** New York: Harper Collins, 1981.

Donald, Richard A. "The Evolution of a Golf Ground," **Outdoor Canada**, 1907. Pages 347 and 353.

Hicks, Kathleen A. **Lakeview: Journey From Yesterday.** Mississauga Library System, 2005.

Lukasewich, Tim, ed. **Centennial Lakeview: High Park to Dixie Road: A celebration of golf from 1896-1996.** Mississauga News, 1996.

Macwood, Thomas. E-mail Correspondence.

Peel Land Registry Records.

Trout, Dan. Interviews and Research Files for Centennial Lakeview publication.

Williams, Bob. Interviews and E-mail Correspondence.

## Appendix 2

Designation Statement for Lakeview Golf Course

## Property information

 1392 DIXIE RD  
 Roll number: 05-07-0-157-03701-0000  
 Legal description: CON 2 SDS PT LTS 6, 7, 43R35295 PTS 2, 5

[View Map](#)
[Property details](#)
[Zoning information](#)
[Building permits](#)
[Development applications](#)
[Committee of Adjustment](#)
[Heritage](#)

### Heritage

Heritage properties can include historic houses or bridges, heritage conservation districts, cultural heritage landscapes and archaeological resources.

If this property has heritage status, the details will be listed below.

Learn more about Mississauga's [heritage properties](#).

### Heritage status

Status	DESIGNATED UNDER THE TERMS OF THE ONTARIO HERITAGE ACT
Conservation district	-
ByLaw	008-2010
ByLaw date	January 20, 2010

### Designation statement

Description of Property: Lakeview Golf Course, 1190 Dixie Road Lakeview Golf Course is an early twentieth century golf course, located on the west side of Dixie Road, north of the Canadian National Railway, in Lakeview. Statement of Cultural Heritage Value or Interest Lakeview Golf Course's cultural heritage value lies in it being one of few remaining traditional tree-lined parkland layout golf courses in an urban setting and one of few remaining courses designed by golf course architect Herbert Strong. Strong's courses were known to be challenging with undulating fairways and severe greens. The course was an early construction project of Thompson, Cumming and Thompson, an important Canadian designer and constructor of golf courses, headed up by Stanley Thompson. Lakeview Golf Course's cultural heritage value also lies in its association with important golf tournaments and their players. The Course hosted the Canadian Open in 1914, 1923 and 1934. It initiated the Ontario Open, the Ontario Amateur Open and the Champion of Champions Tournament. It also hosted several other provincial championships. Lakeview Golf Course's cultural heritage value also lays in its history as a resort/recreational facility for York (Toronto) residents. Description of Heritage Attributes Key attributes of Lakeview Golf Course that reflect its value as a traditional course, in an urban setting, designed by Herbert Strong: > its location, orientation and dimensions > its mature trees and other vegetation and their/its placement > the inclusion of 18 holes and their layout > the placement and orientation of the original tees, fairways, greens, bunkers and other hazards, natural or otherwise, on varying topographical features > the original 11th and 18th tees - these should not be dug up, nor should any vegetation be planted on them > the bunker in front of the 9th green - this is integral to the original design > the shape and form of the greens > the staff dwelling at 1392 Dixie Road, with its broad gently pitched roof that covers the veranda; chimney; Edwardian elements, including a Classical pediment, the short colonettes, with their decorative

mouldings, on brick piers that support the veranda roof, the veranda balustrade, the fenestration, including the bay windows and sidelights flanking the main entrance, and wood siding. Key attributes of Lakeview Golf Course that reflect its value as a site of important tournaments and competitors: > the original Herbert Strong layout with its original par - returning the course to its original 70 par is encouraged Key attributes of Lakeview Golf Course that reflect its resort/recreational history value: > its location near to Toronto and immediacy to the railway line

## Inventory item

Inventory No.	Property name	Decade	Constructed	Demolished/Year
<a href="#">549</a>	LAKEVIEW GOLF RESIDENCE	1900		N

How can we improve this site?

Translate this page

Powered by  

Find

Publications

Pay, apply, report

Services A to Z

Get in touch

Contact Us

Get email updates

Social

 Twitter

 Facebook

 LinkedIn



## Appendix 3

Topographic Survey: 2023-11-09 - 1190 Dixie Road FS128 - Office Topo

Topographic Survey including tree trunk caliper: 2024-03-19 - 1190 Dixie Road FS128 - Office Topo  
North Side

# 1190 Dixie Road FS128 Office TOPOGRAPHICAL PLAN

## LEGEND

	Hydro Pole		Index Contour
	Fire Hydrant		Intermediate Contour
	Catch Basin		Back of Curb
	Storm Manhole		Road Curb
	Deciduous Tree		Edge of Pavement
	Coniferous Tree		Gravel Outline
	Shrub		Chain Link Fence
	Post/Bollard		Property
			Boundary Line
			Dashed Traffic Line
			Solid Traffic Line
			Sidewalk
			Treed Area
			Hedge
			Lockstone
			Retaining Wall

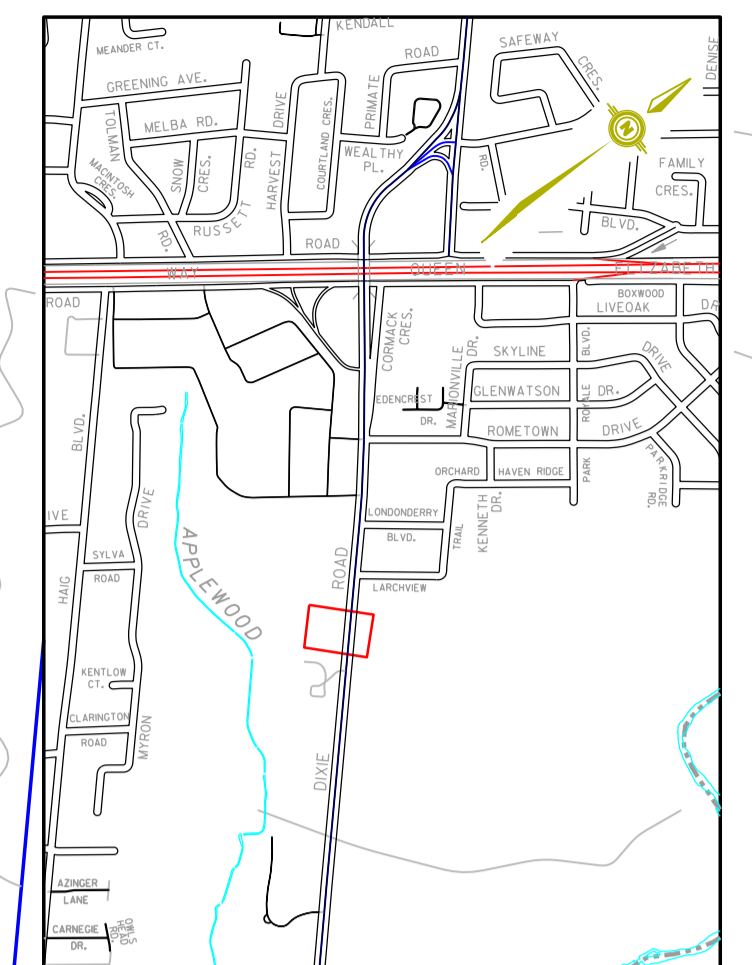

1411 KEY PLAN  
N.T.S.

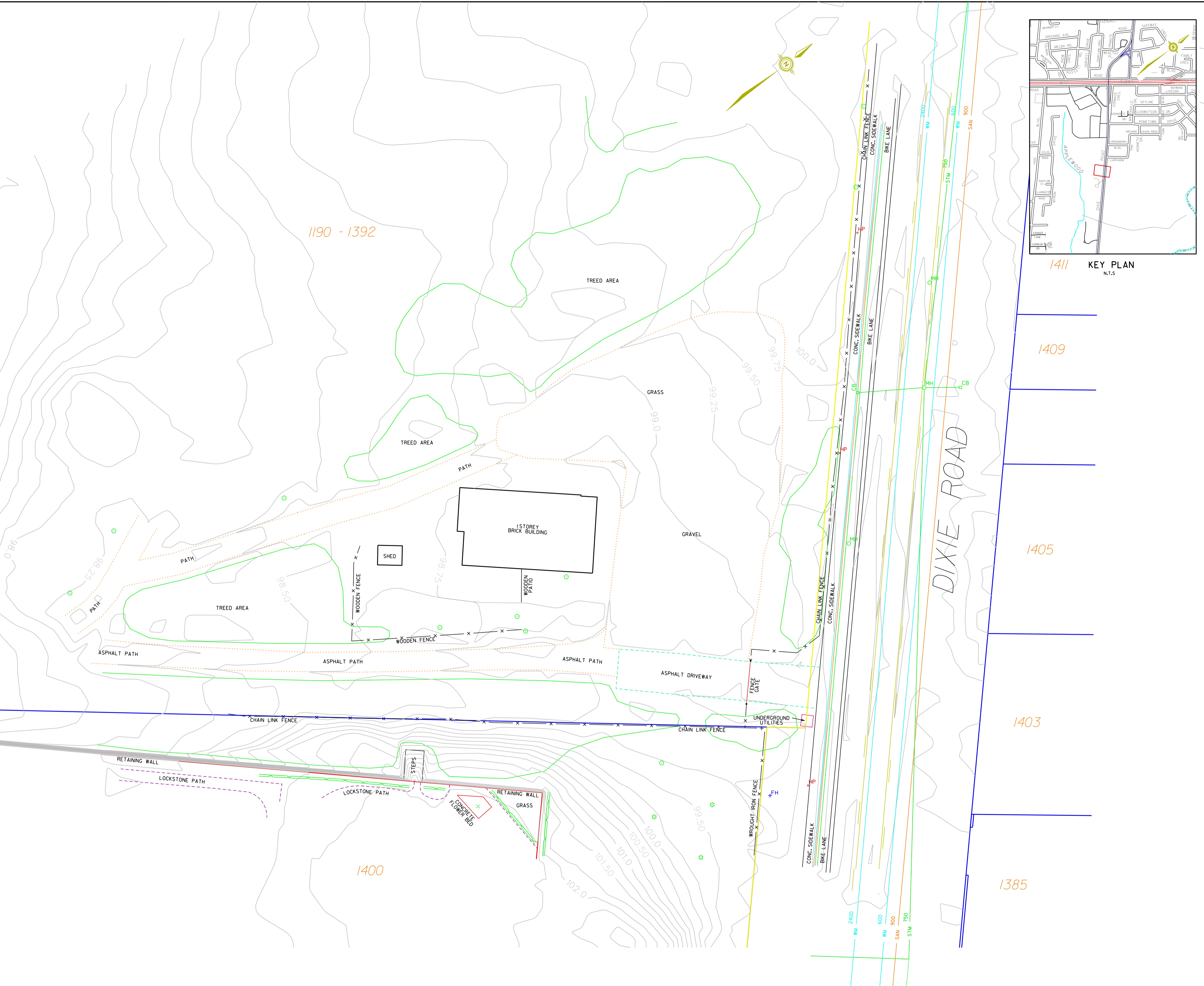

1409

1405

1403

1385

Note :  
Contour interval equals 0.25 metres.

Utility lines shown on the plan are in compliance with CIASCE Standard 38-02 Level D. The information has not been verified by field survey.

Property Lines shown on the plan are graphic representations and are taken from available office records. They have not been verified by field survey.

Caution :  
Before digging, services should be located on site by the respective agencies.

It is the responsibility of the contractor to ensure that the local bench marks have not been altered or disturbed and that their relative elevations and descriptions agree with the information shown on this plan.

Boundary information shown herein is derived from the City's cadastral land base. This is not a Plan of Survey.

All measurements are to be verified in the field

Information contained in this plan is intended for the use by the City of Mississauga only.

## SOURCE DATA

PHOTOGRAMMETRY:  
Elevations shown were acquired photogrammetrically from 2022 digital aerial imagery with the ground sampling distance(GSD) of 7.5cm and are related to the Geographic Coordinate System NAD83 /UTM Zone 17N.

From 2022 the digital aerial imagery data (well defined points) was compiled to meet or exceed a horizontal accuracy of +/- 0.13m and a vertical accuracy of +/- 0.19m at 95% confidence level.

Note: The information has not been verified by field survey.

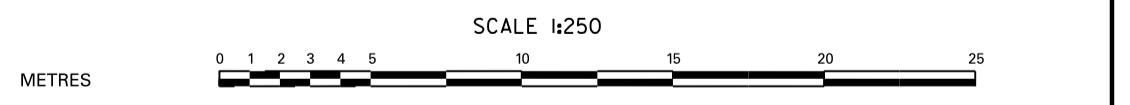

FILENAME: I:\cadd\Projects\Topo Surveys\237591 1190 Dixie Road FS128 - Office Topo\_T\Vector\0Dixie Road FS128 - Office Topo.dgn

PLOTTED : NOVEMBER 2023

AREA Z-06, Z-05



# 1190 Dixie Road FS128 Office TOPOGRAPHICAL PLAN

## LEGEND

Hydro Pole	Index Contour
Guy Pole	Intermediate Contour
Fire Hydrant	Back of Curb
Catch Basin	Road Curb
Storm Manhole	Edge of Pavement
Deciduous Tree	Gravel Outline
Coniferous Tree	Chain Link Fence
Shrub	Property
Post/Bollard	Boundary Line
	Dashed Traffic Line
	Solid Traffic Line
	Sidewalk
	Treed Area
	Hedge
	Lockstone
	Retaining Wall
	Storm Sewer
	Sanitary Sewer
	Watermain
	Gas

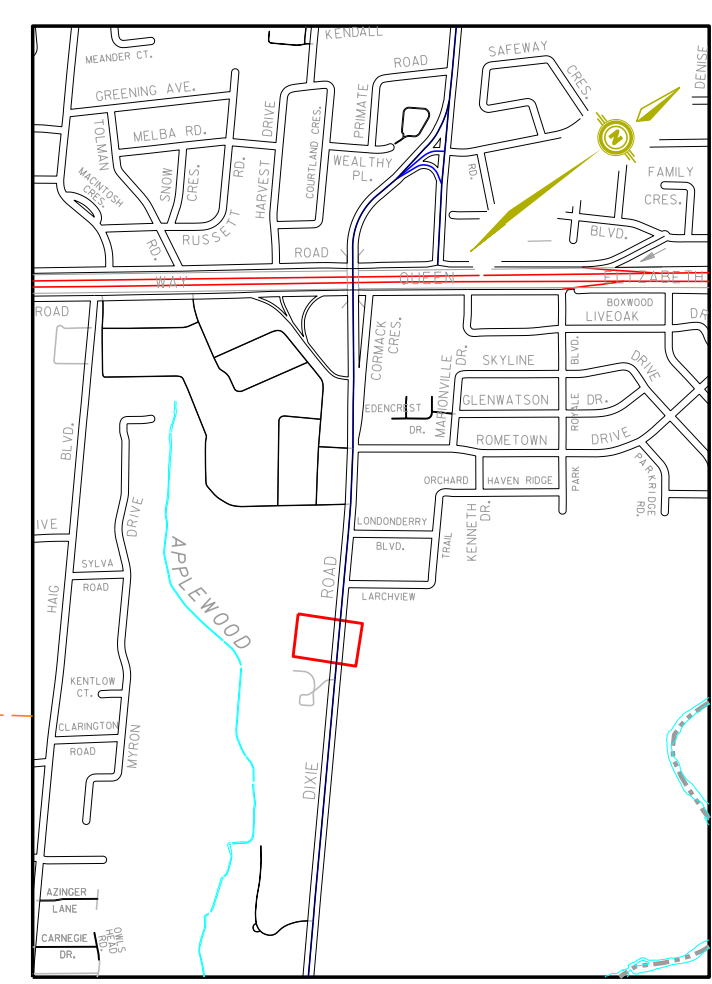

KEY PLAN  
N.T.S.

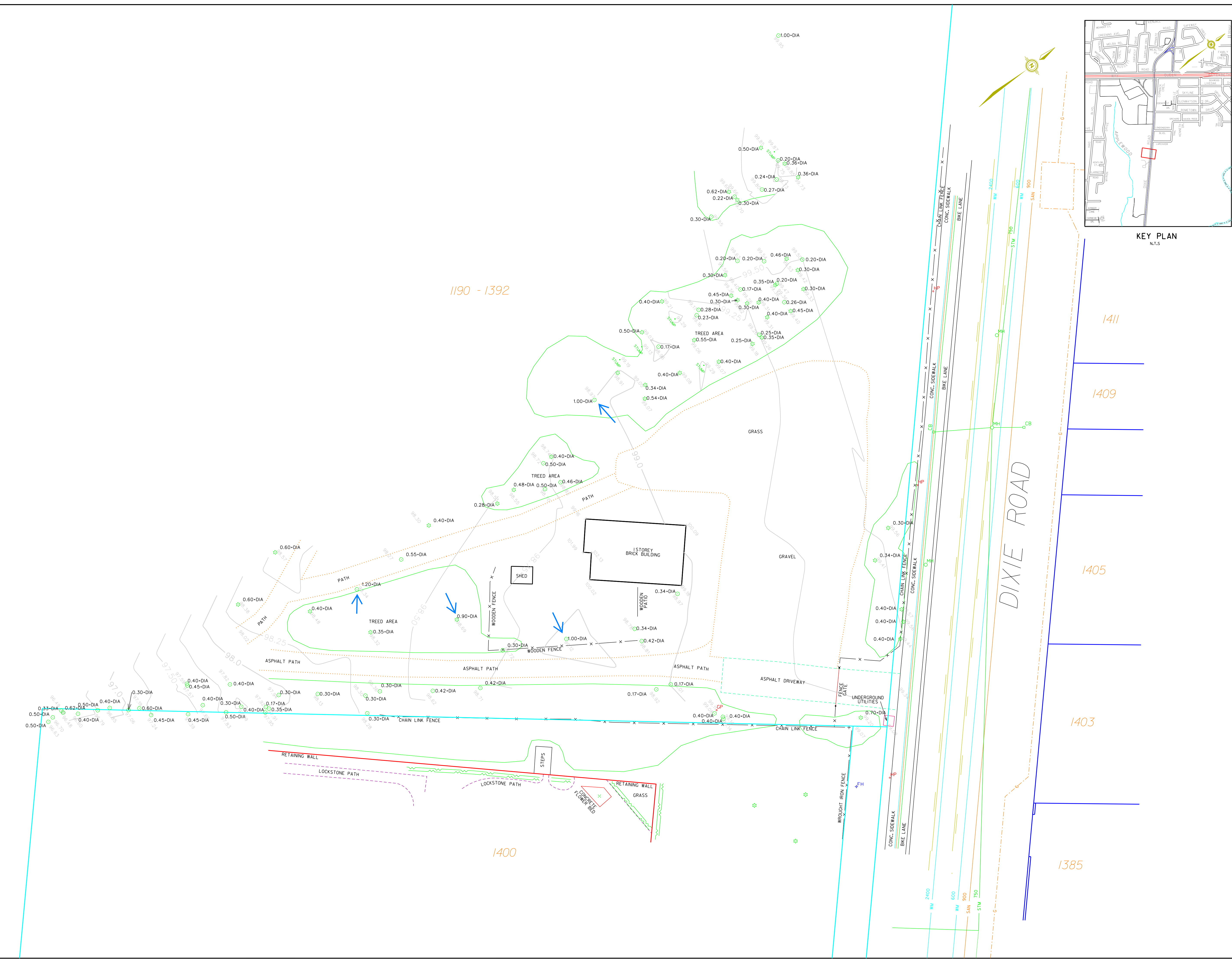

Note :

Contour interval equals 0.25 metres.

All tree diameters are in meters unless other specified.

Utility lines shown on the plan are in compliance with C/ASCE Standard 38-02 Level D. The information has not been verified by field survey.

Property Lines shown on the plan are graphic representations and are taken from available office records. They have not been verified by field survey.

Caution :

Before digging, services should be located on site by the respective agencies.

It is the responsibility of the contractor to ensure that the local bench marks have not been altered or disturbed and that their relative elevations and descriptions agree with the information shown on this plan.

Boundary information shown hereon is derived from the City's cadastral land base.

This is not a Plan of Survey.

All measurements are to be verified in the field

Information contained in this plan is intended for the use by the City of Mississauga only.

## SOURCE DATA

**PHOTOGRAMMETRY:**

Elevations shown were acquired photogrammetrically from 2022 digital aerial imagery with the ground sampling distance (GSD) of 7.5cm and are related to the Geographic Coordinate System NAD83 / UTM Zone 17N.

From 2022 the digital aerial imagery data (well defined points) was compiled to meet or exceed a horizontal accuracy of +/- 0.13m and a vertical accuracy of +/- 0.19m at 95% confidence level.

Note: The information has not been verified by field survey.

**FIELD SURVEY :**

Topographic data shown on this plan has been derived from a field survey completed on March 11, 2024. Elevations shown are derived from:

Control Monument No. 977  
Elevation : 96.942

**DESCRIPTION**  
Cut arrow set at the South-East corner of the top of inground Bell concrete chamber located 26m South of the centreline of Clarington Road and 8m East of the centreline of Haig Blvd.

Control Monument No. 42  
Elevation : 100.477

**DESCRIPTION**  
On the West face at the North corner of a garage of a red brick house #1393, on the East side of Haig Blvd, 137m South of Sylvia Road.

Note: Elevations shown are to the Canadian Geodetic Datum, 1928 (not the 1978 Southern Ontario Adjustment).

City of Mississauga, Transportation and Works Department, Work Operations and Maintenance Division, Technical Services Section, Surveys and Inspections

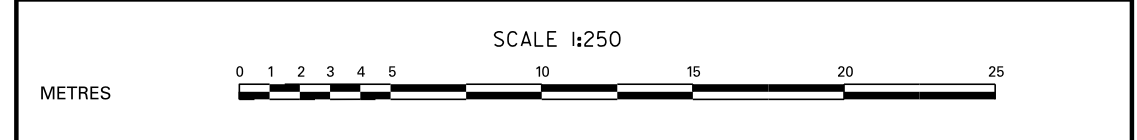

FILENAME: \\cadd\Projects\Topo Surveys\227591 1190 Dixie Road FS128 - Office Topo\Vector\227591 1190 Dixie Road FS128 - Office Topo North Side.dwg

PLOTTED : MARCH 2024 AREA Z-6, Z-5



## Appendix 4

Excerpt: Cultural Landscape Inventory: City of Mississauga, January 2005 (see pdf page 83)

## Lakeview Golf Course

## L-PA-5

**Location** West side of Dixie Rd. between Lakeshore Road and the QEW.

**Heritage or Other Designation** None

**Landscape Type** Park (Golf Course)

### LANDSCAPE ENVIRONMENT

- Scenic and Visual Quality
- Natural Environment
- Horticultural Interest
- Landscape Design, Type and Technological Interest

### HISTORICAL ASSOCIATION

- Illustrates Style, Trend or Pattern
- Direct Association with Important Person or Event
- Illustrates Important Phase in Mississauga's Social or Physical Development
- Illustrates Work of Important Designer

### BUILT ENVIRONMENT

- Aesthetic/Visual Quality
- Consistent Early Environs (pre-World War II)
- Consistent Scale of Built Features
- Unique Architectural Features/Buildings
- Designated Structures

### OTHER

- Historical or Archaeological Interest
- Outstanding Features/Interest
- Significant Ecological Interest
- Landmark Value



**Lakeview Golf Course****L-PA-5**

---

**SITE DESCRIPTION**

The Lakeview Golf Course was originally known as the High Park Golf Club, formed in 1896. The golf club relocated to its present site in 1907, and in 1912 its name was changed to the Lakeview Golf and Country Club Limited. The club became highly popular, hosting the Canadian Open in both 1923 and 1934. In 1939, a fire destroyed its thirty-room clubhouse. For the next fifteen years, the property was privately and semi-privately owned. Between 1956 and 1964 the Township of Toronto leased the property. Now known as the Lakeview Golf Course, the site was purchased in 1965 by the Township of Toronto and is currently owned and operated by the City of Mississauga. It is now open to the public.

---

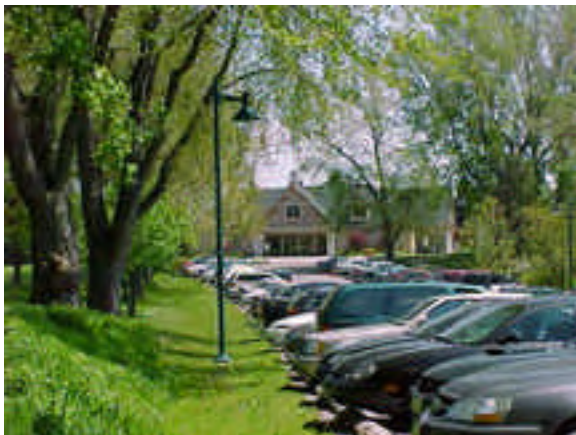

## Appendix 5

City of Mississauga's Template Design and Standards for New Fire Stations (October 2020 version)

**city of mississauga**

# Template Design and Standards for New Fire Stations

October 2020







# table of contents

<b>1.0</b>	<b>executive summary</b>	<b>01</b>
	1.1 introduction	01
	1.2 program summary	02
	1.3 proposed concepts summary	03
<b>2.0</b>	<b>functional program</b>	<b>05</b>
	2.1 detailed program	05
	2.2 fire station design principles	30
	2.3 adjacency diagram	32
	2.4 green design	34
<b>3.0</b>	<b>site design</b>	<b>47</b>
	3.1 two truck one storey site plan	48
	3.2 two truck two storey site plan	49
	3.3 three truck one storey site plan	50
	3.4 three truck two storey site plan	51
<b>4.0</b>	<b>floor plans</b>	<b>53</b>
	4.1 two truck one storey	54
	4.2 two truck two storey	56
	4.3 three truck one storey	60
	4.4 three truck two storey	62
	4.5 area comparison plans	66
<b>5.0</b>	<b>engineering guidelines</b>	<b>71</b>
	5.1 structural engineering guideline	72
	5.2 mechanical engineering guideline	74
	5.3 electrical engineering guideline	78
	5.4 civil engineering guideline	84
appendix A	<b>program development chart</b>	
appendix B	<b>structural engineering feasibility review</b>	
appendix C	<b>mechanical engineering feasibility review</b>	
appendix D	<b>electrical engineering feasibility review</b>	
appendix E	<b>civil engineering feasibility review</b>	



# 1.0 executive summary

## 1.1 introduction

The Corporation of the City of Mississauga (the “City”) retained dpai architecture inc. as Prime Consultant in the preparation of floor plan template designs and design brief standards study capturing City of Mississauga Fire and Emergency Services (MFES) programming requirements for future new fire station projects.

dpai retained Bold Engineering for the preparation of structural, mechanical, and electrical engineering briefs and standards.

The project’s intent is to provide guidance for the floor plan design and design brief standards including finishes, mechanical, electrical and site related requirements of future new Fire Station facilities. The following report identifies 4 schemes of final layouts of proposed floor plan designs for future facilities. These layouts are intended to be included in future fire station RFP’s to be used as a basis for design. These layouts may need to be adjusted to suit site parameters however will capture road sizes and adjacencies of the approved program. These layouts should be used as a reference only and it should not be assumed that these represent the final approved layout. Every effort should be made by future consultant teams to keep areas and circulation to a minimum.

The floorplans and standards were developed using the following approach:

### *1. Information Gathering and Program Development Phase*

Initially the consultant team reviewed the base program provided in the RFP and visited two precedent stations to gather information on current fire station programmatic requirements and standards.

The consultant team also reviewed the City of Mississauga Corporate Green Building Standard (December 30, 2019) as a guide to propose sustainability standards and design approaches in the new fire stations.

The City of Mississauga 2015 Facility Accessibility Standards (FADS) were used as a guide to inform accessibility requirements in the proposed design.

The developed program and standards were presented to the steering committee and a select user group representing MFES for feedback.

Based on the feedback a final program was developed that guided the development of the floor plan designs and engineering briefs.

### *2. Floor Plan Layouts, Engineering Briefs, and Standards Development*

The consultant team developed four schemes for floor plan template design that can be used for future fire station builds. Layout options include:

- Single Storey, 2 bay apparatus garage
- Single Storey, 3 bay apparatus garage
- Two Storey, 2 bay apparatus garage
- Two Storey, 3 bay apparatus garage

Engineering design briefs for mechanical, electrical and site related requirements were also developed for each scheme.

## 1.2 program summary

General Information	
Occupant Load	2 crews per truck, 5 people/crew (1 captain and 4 fire fighters)
Accessibility	All areas accessible to the public and to injured fire fighters to be designed per City of Mississauga FADS
Cold Side / Living Areas / Clean Areas	
Vestibule/Lobby	Accessible, space of refuge, within 30m of accessible parking space
Captains' Rooms	1 room per captain, accessible with accessible path of travel, near the station entrance
Dorm Room	Separate room for each truck's crew, permanent semi-private sleeping areas with a bed and desk for each firefighter
Locker Room	Separate gender neutral locker room with change rooms, adjacent to washrooms and showers, 16 per truck
Showers	Four gender neutral shower stalls for both two and three truck stations, mainly used for decontamination
Washrooms	Four gender neutral washrooms with toilet and sink for both two and three truck stations
Captain's Washroom/ Universal Washroom	Universal washrooms doubles as the captains' washroom designed per the City of Mississauga Facility Accessibility Design Standards. Includes toilet, sink and shower.
Kitchen	Contains fridges, stove, dishwasher, kitchen island, shift food storage lockers, ample storage, adjacent to dining area and lounge
Dining	Comfortably seats 12 staff for two truck station and 17 staff for 3 truck stations, with provisions for tackable and writable surfaces
Lounge	Separate room built to accommodate a TV and recliner chairs (10 for 2-truck station and 15 for 3-truck station)
Workstations	Computer stations with cisco webex requirements - 2 computer workstations for a 2 truck station; 4 computer workstation for a 3 truck station.
Outdoor Area	Direct access from the dining area; gas grill; seating for: 8-10 people for a 2 truck station, 15 people for a 3 truck station; fenced off for privacy
Gym	Gym / workout area large enough to accommodate equipment and 5 staff; approx. 30 sqm for a 2 truck station, 45 sqm for a 3 truck station
IT Room	To house servers; Provide adequate cooling in this room; Locate centrally on the plan
Hot Side / Contaminated Areas	
Apparatus Bay	Designed to aerial fire truck specification; accommodates support vehicle; roll up doors; IR Heater; full length EVEC System; hose drying rack
Bunker Gear Storage	Self-contained Bunker Gear Room complete with recirculation system and racks for gear storage (40 for 2-truck station, 50 for 3-truck station)
Gear Washer + Dryer + Laundry + Shop	Combined laundry and shop. Adjacent to the bunker gear storage, includes stacked washer and dryer and a Unimac gear extractor equipment unit + 1 drying rack per truck. Provide 1 work bench, wall tool storage, 1 storage cabinet, and a sink for face piece washing.
Compressor Room	Accessed off the apparatus bay to house compressor, air regulator chamber with fill stations, cascade bottles and bottle storage racks. 3.6 x 3.6 m
Material Storage	A nook off the apparatus bay that accommodates a standard (48"x40") pallet. Should be placed near the rear bay access point for material loading.
Support Spaces + Critical Equipment	
Mechanical Room	Mechanical room within the floor area to accommodate central vacuum and a hot water tank
Electrical Room	Electrical room approximate area to be 10 sqm. ASCO automatic transfer switch is preferred.
Storage Room	General purpose storage rooms in hot and cold sides. A separate first aid supply storage cabinet to be accommodated on hot side.
Janitor Room	Two rooms (one for hot side, one for cold side) Includes slop sink for the cleaning of apparatus bays/ contaminated areas
Outdoor Storage Shed	Outdoor storage room to be provided with outdoor access, can be combined with sprinkler room
Sprinkler Room	Room to accommodate incoming fire pipes; Direct Access to the outside closest to the street edge
Generator	Full back up natural gas generator on site external to the building footprint

## 1.3 proposed concepts summary

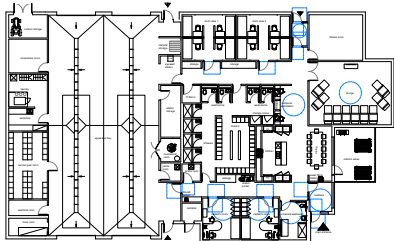

**2 trucks - 1 storey**  
 building footprint: 960 sqm  
 gross floor area: 960 sqm

minimum site dimensions:  
 63 m site frontage, 57 m site depth, 0.9 Acre *or*  
 67 m site frontage, 53 m site depth, 0.9 Acre

The concepts explored the most compact space possible to satisfy the programmatic requirements.

The circulation between the apparatus bays and living areas is designed as a continuous u-shape that is clear of obstructions. Dorm rooms and captain rooms are situated closest to the apparatus bays. In two storey schemes, the exit stair opens up directly onto the apparatus bays to allow for faster response times.

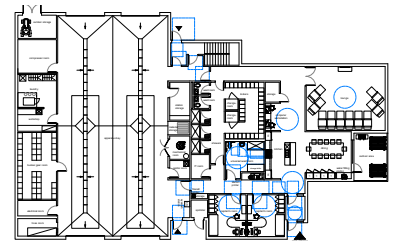

**2 trucks - 2 storey**  
 building footprint: 825 sqm  
 gross floor area: 1002 sqm

minimum site dimensions:  
 61 m site frontage, 57 m site depth, 0.9 Acre *or*  
 68 m site frontage, 49 m site depth, 0.8 Acre

The kitchen and dining area are designed as a single open plan space with direct access to the outdoor area, and provisions for ample natural light.

All floorplans show a separation of showers and washroom facilities. This was designed as a contamination control measure. There are two access points into the shower/ washroom/ locker area:

- The contaminated access point is directly adjacent to the the showers, closer to the access from the apparatus bays. This configuration controls the spread of contamination into the clean areas after responding from a call. Firefighters usually take a shower after returning from a call to decontaminate.
- The clean access point is adjacent to the washrooms so that fire fighters may use those facilities when using the facilities on the clean side.

All plans incorporated a hose rack nook as it was indicated as the preferred option for hose drying and storage.

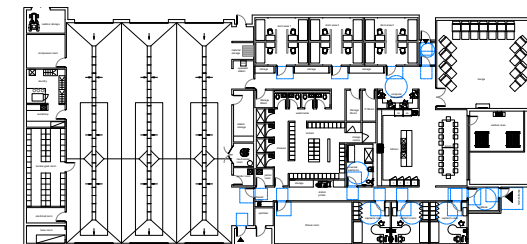

**3 trucks - 1 storey**  
 building footprint: 1313 sqm  
 gross floor area: 1313 sqm

minimum site dimensions:  
 76 m site frontage, 62 m site depth, 1.2 Acres *or*  
 67 m site frontage, 72 m site depth, 1.2 Acres

For each concept, a site plan was explored using specific parameters detailed under Section 3.0 Site Design. The aim of this exercise is to determine the minimum site dimensions required to accommodate each proposed concept. This can be used as a guide for the City of Mississauga when considering future properties for the development of new fire stations.

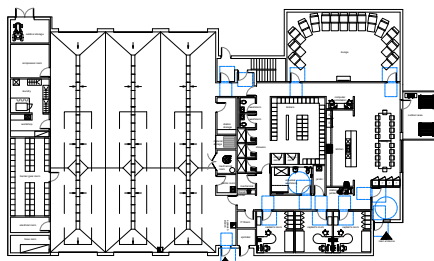

**3 trucks - 2 storey**  
 building footprint: 1087 sqm  
 gross floor area: 1345 sqm

minimum site dimensions:  
 68 m site frontage, 62 m site depth, 1 Acre *or*  
 68 m site frontage, 68 m site depth, 1.2 Acre



## 2.0 functional program

### 2.1 detailed program

#### Occupant Load

All fire stations to be outfitted to accommodate 2 crews per truck  
5 people/crew = 4 fire fighters + 1 captain

Total number of individuals for a 2 truck fire station:  
10 people/shift = 8 fire fighters + 2 captains  
2 shift change = 20 people

Total number of individuals for a 3 truck fire station:  
15 people/shift = 2 fire fighters + 3 captains  
2 shift change = 30 people

#### Accessibility Requirements

Per City of Mississauga 2015 Facility Accessibility Standards Section 4.5.11 Fire Stations:

Municipal fire stations should accommodate the accessibility needs of potential facility users (while supervised), including but not limited to:

Injured staff attending a Captain's office or other meeting space within the facility;

Accessible path of travel to be provided to Captain's offices, universal washroom, and day room.

Administration staff, Council Members, Consultants, etc attending site visits;

Occasional uses of the facility. Fire stations contain spaces that may be used by the public while supervised by staff;

Use by members of the general public in an emergency situation. Fire stations are post-disaster buildings, thereby, should perform as a barrier free space.

Pedestrian walk-up &/or vehicular drop-in requests for assistance/emergency services;

Areas of fire stations likely to be used by the public, such as the apparatus bays and universal washroom, should be accessible for persons with disabilities.

Facilities not required to be accessible are those for the exclusive use of firefighters such as hose towers, fitness rooms, 2nd floors, dormitories, and any basement level storage space.

Fire stations to ideally be on a single level due to response time and to prevent tripping hazards. (However, drive-through bays are a priority if it can be accommodated in a two storey building.)

An accessible path of travel shall be provided from accessible public entrances to all spaces that are accessible to the public or intended for access/viewing by visitors. These spaces include the day room and apparatus bays.

Where more than 3 entrances are provided, minimum 2 barrier-free entrances are required (per OBC).

Spaces that may be used by community and public within fire stations shall be accessible.

Common-use areas within a fire station shall comply with all relevant sections of this Standard. However, the kitchen area is not required to be fully accessible with specialty designed millwork and appliances.



## Vestibule/Lobby

- Front Entrance reconfiguration to include for emergency lock (outdoor door unlocked at all times with thumb turn on interior – the purpose is for the vestibule to serve the public in cases of emergency providing a secure lockable area from external danger). Interior door designed with panic hardware.
- dry sprinkler
- pedimat
- security camera
- entry phone in vestibule
- door bell on interior door
- card reader on interior door
- Entrance should be accessible with automatic door operator

### accessibility clearances

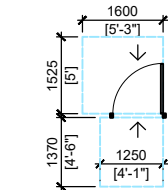

front approach (per FADS 4.1.6)

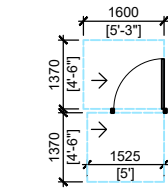

latch-side approach (per FADS 4.1.6)

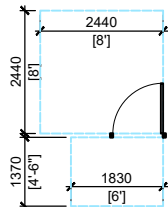

hinge-side approach (per FADS 4.1.6)

### vestibule

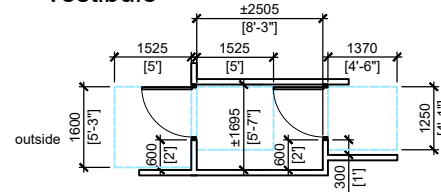

Manoeuvring Space at Doors in Series - Doors Aligned (per FADS 4.1.6)

The minimum space between two hinged or pivoted doors in series shall be 1525 mm (60 in.), plus the width of any door swinging into the space.

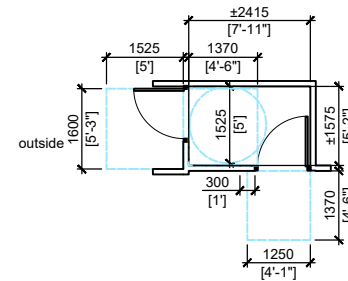

Manoeuvring Space at Doors in Series - Doors Not Aligned (per FADS 4.1.6)

Where doors in a series do not align, a turn circle of at least 1525 mm (60 in.) shall be provided within the vestibule area, clear of any door swing. (See figure 4.1.6.6)

## Fire Call printer

To be placed near access to the apparatus bay from the day room

## Captains' Rooms

each captain has a separate room with:

- a bed - twin XL 39"x90"
- 4 full lockers (18") (1 per captain)
- main workstation table (30"x70") with 'p' shape return, height adjustable
- main workstation to be facing door
- 2 workstation chairs
- printer
- writable and tackable surfaces
- 4-up filing cabinet (36"w x 18"d)
- operable windows with black out shades
- Wall mounted TV

### space components

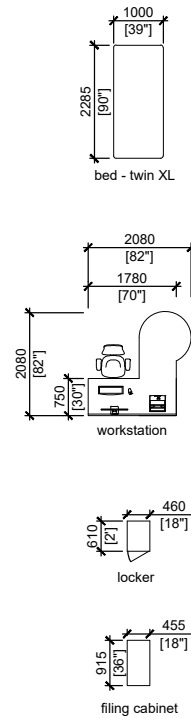

### 2 & 3 truck options

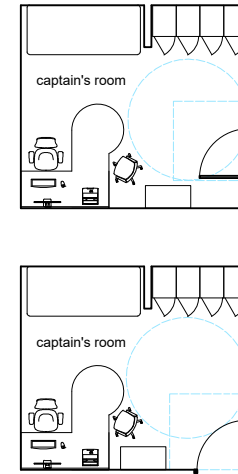

## Dorm Room

Fire fighters have a shared dorm room that contains individual sleeping areas.

For each person, a sleeping area includes:

- an outlet for each bed with combo usb outlet, desk, chair, night light reading lamp, and clothing hooks near each bed.
- Sleeping areas are separated by a 4' wall on each side.

For a 2 truck station:

- Total of 8 beds, 8 desks, 8 chairs

For a 3 truck station:

- Total of 12 beds, 12 desks, 12 chairs

- Dorm is subdivided by occupants of each truck
- No carpet in dorm area
- door lite required for health and safety reasons
- night lite low at floor
- humidity control
- and fan for air circulation and white noise
- operable windows with black out shades

### space components

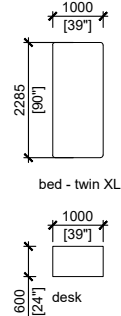

### Sleeping area layouts

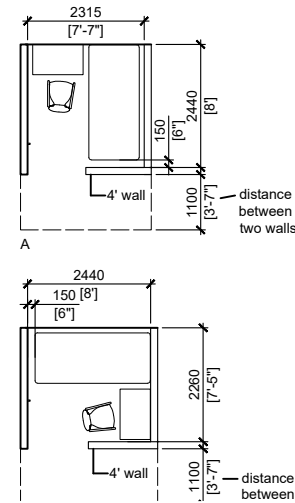

### Suggested Elevation:

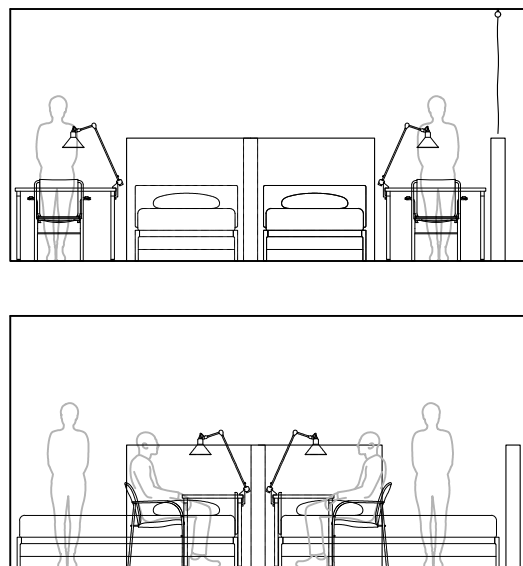

### configurations (2 trucks)

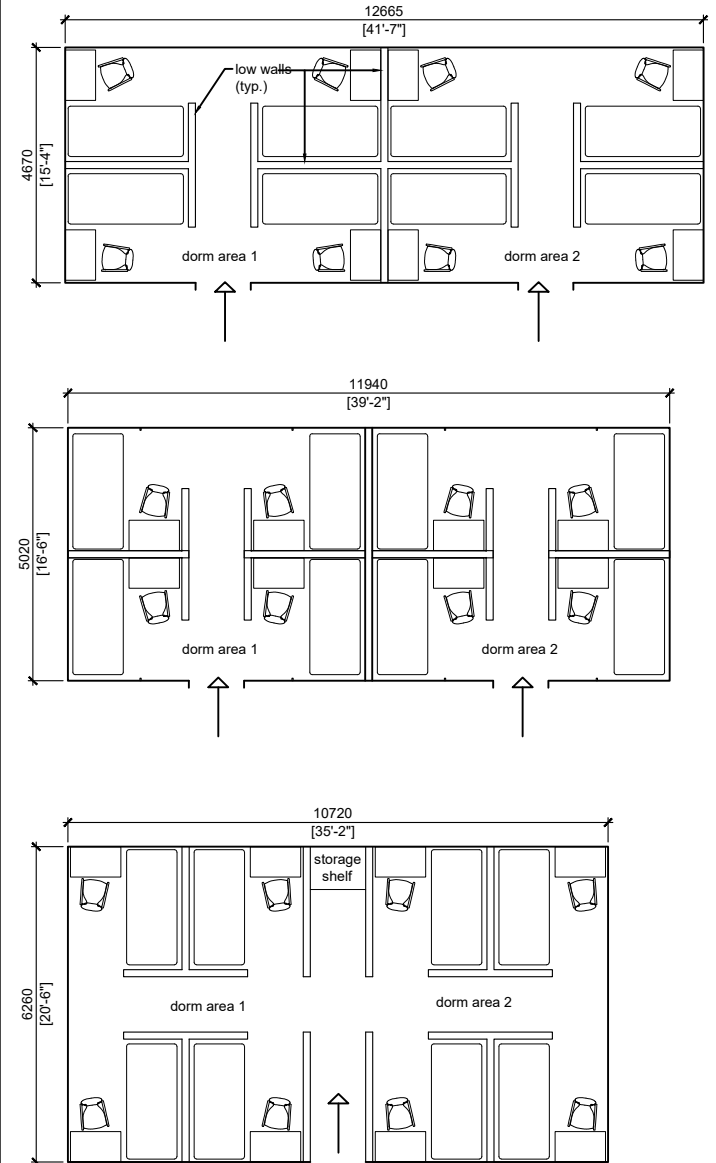

configurations (3 trucks)

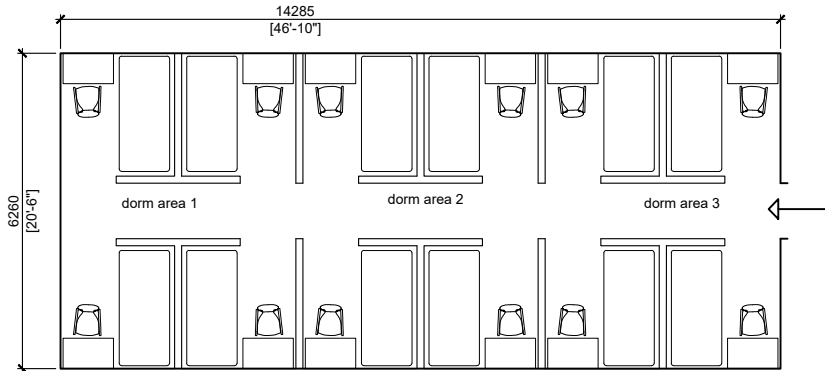
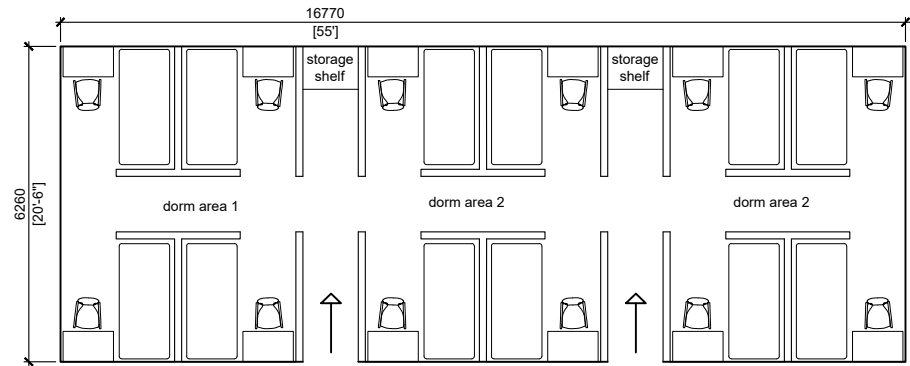
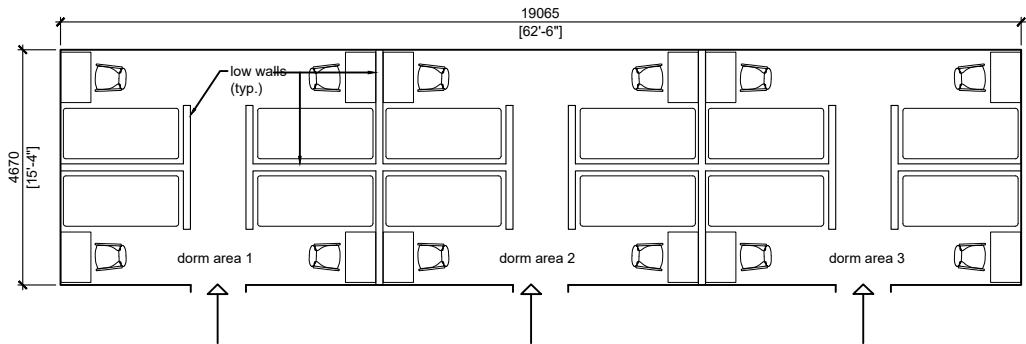

## Locker Room

- 18" lockers
- ideally placed in a separate space from sleeping area
- adjacent to shower and washroom facilities
- Locker area to include benches and change rooms
- number of lockers:  
32 for 2-truck station  
48 for 3-truck station

space components

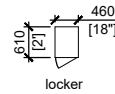
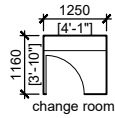

### 2 truck options

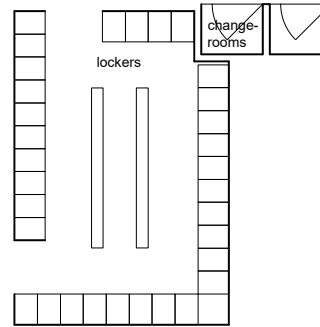

A

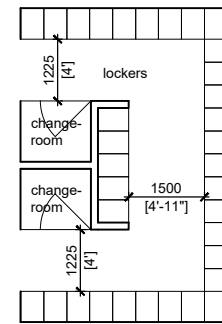

B

### 3 truck options

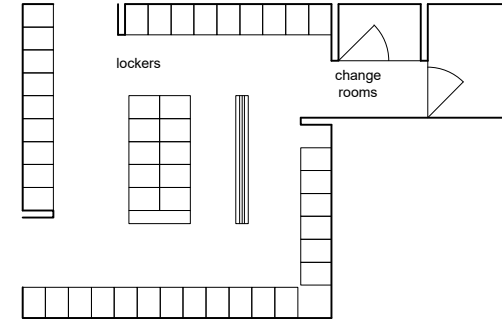

A

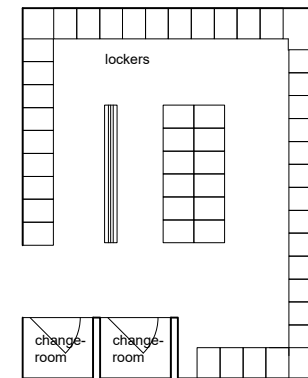

B

## Washrooms

- Four gender neutral, stand-alone washrooms each with toilet and sink.
- Automatic flush fixtures, faucets and soap dispensers
- Washrooms are preferably standalone without shower stalls, so they may be used even when showers are occupied.
- Washrooms to be placed in closer proximity to living areas to avoid circulation within the contaminated shower zone.

## Showers

- Four gender neutral, stand-alone showers.
- Showers are primarily used for decontamination of firefighters.
- Showers should be placed close to the access from the apparatus bays.
- The circulation sequence for controlled contamination should be designed so that firefighters access the shower area first to decontaminate before accessing the living areas.

### space components

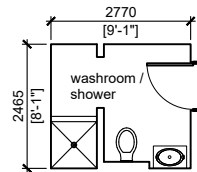
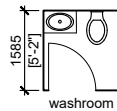
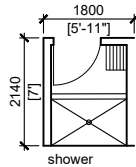

### seperated shower and washroom

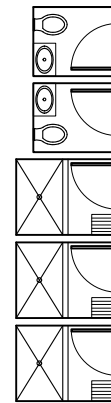
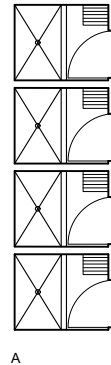
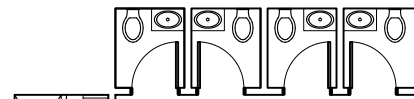

B

### combined shower and washroom

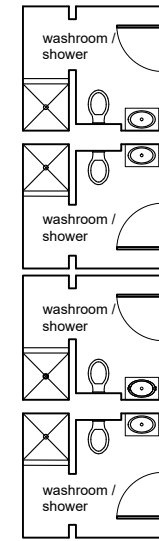

A

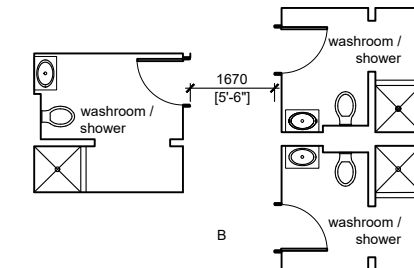

B

## Captain's / Universal Washroom

- 1 gender neutral universal washroom with toilet, sink, and shower.
- Universal washroom does not require an adult-sized change table (but space for an adult sized change table must be provided); and have a baby change table.
- Can serve as captains' washroom

### accessibility standards

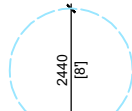

accessibility turning radius

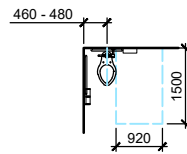

barrier free toilet per FADS 4.2.3

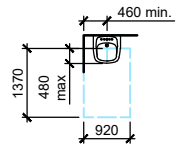

barrier free toilet per FADS 4.2.4

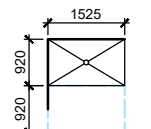

barrier free shower per FADS 4.2.9

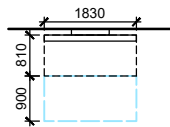

fold-down adult sized change table per FADS 4.2.7

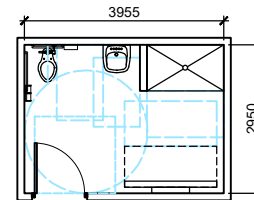
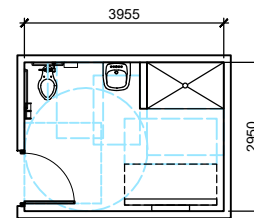

FADS 4.2.7.1 Universal Washroom + Shower

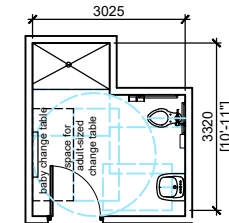

FADS 4.5.11.2 Universal Washroom - Alternate design for fire Stations

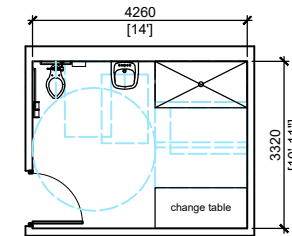

FS 120 universal washroom / captain washroom

## Dayroom

- Day room area is a multi use space that incorporates a kitchen, dining area, lounge and access to an outdoor space.
- Kitchen and Day room reconfiguration to provide comfortable space for:
  - 10 staff for a 2 truck station
  - 15 staff for a 3 truck station
- Integrate computer stations with cisco webex requirements into Day Room.
  - 2 computer workstations for a 2 truck station;
  - 4 computer workstation for a 3 truck station.
- Lighting to be placed on dimmers.
- Multiple switching to be able to separate areas in common spaces. Not all lighting is on one switch.

### space components

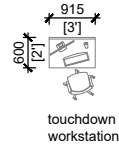

### 2 truck options

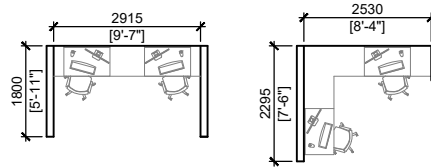

### 3 truck options

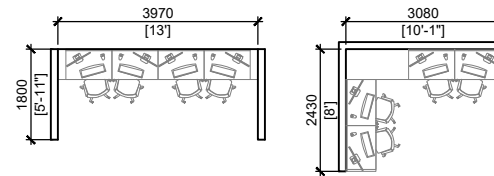



## Dayroom - Lounge

- Lounge with recliner chairs and built to accommodate a TV.
- Lounge should be a separate room acoustically but visually connected to the kitchen dining area with a glazed screen wall or glazed doors
- The lounge doubles as a training room for presentations etc.

### space components

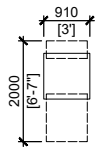

recliner chair



TV



accessibility clearances

### 2 truck configurations

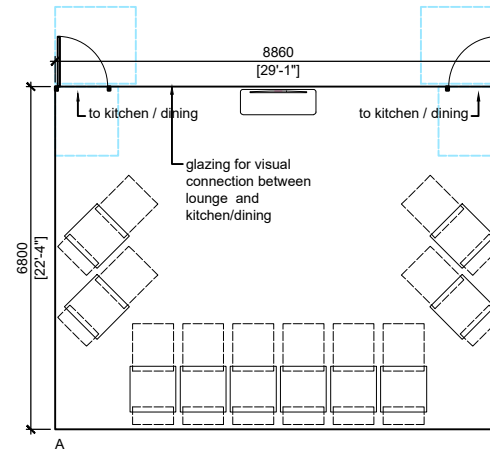

### 3 truck configurations

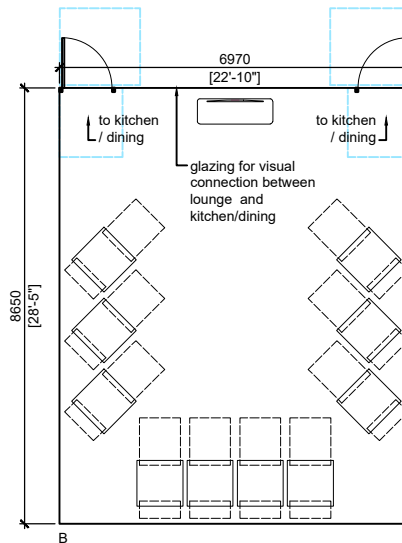
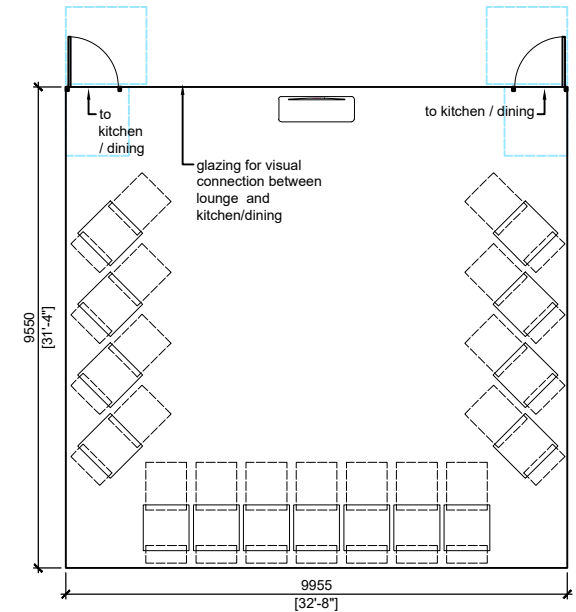

## Dayroom - Kitchen

- Kitchen to contain lockable shift food lockers – 1 per crew. Shift food lockers preferably to be divided into upper and lowers with counter space in between.
- Upper cabinets required in kitchen.
- Kitchen to contain: 2 fridges and 4 storage cabinets, a water filling station, a gas stove, 1 dishwasher for a 2 truck station and 2 dishwashers for a 3 truck station.
- adjacent to dining area and outdoor area
- natural light

### 2 truck options

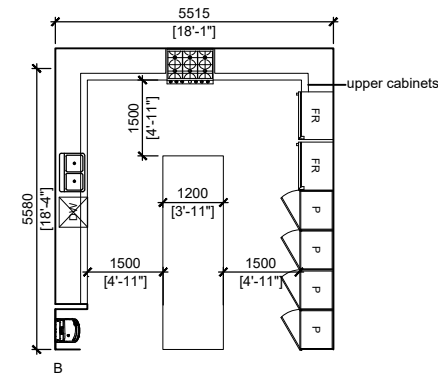
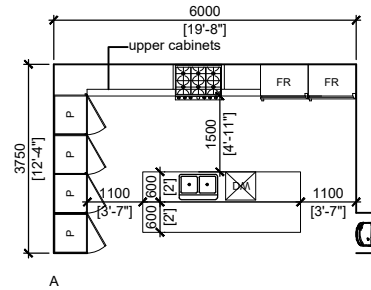

### space components

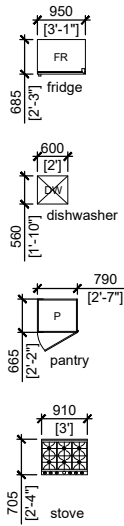

### Pantry Configurations

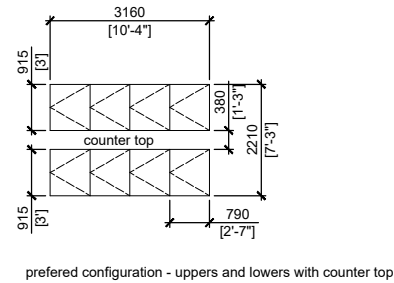

preferred configuration - uppers and lowers with counter top

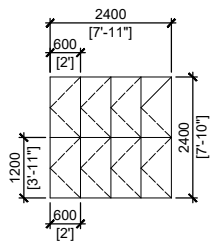

alternate configuration - full cabinets

### 3 truck options

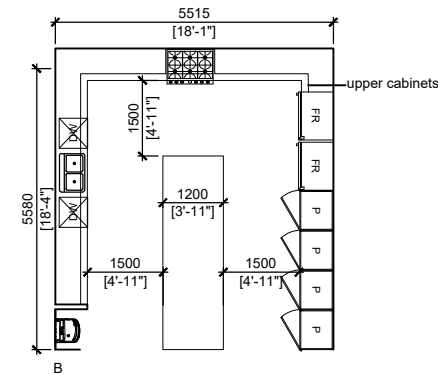
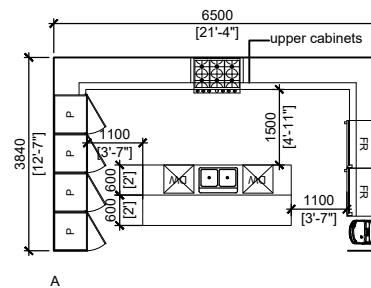

## Dayroom - Dining

- Dining table to seat:  
12 people for a 2 truck station  
17 people for a 3 truck station
- Provide white boards and tack boards in dining area
- Adjacent to dining area and direct access to outdoor area
- natural light

### space components

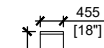

dining chair

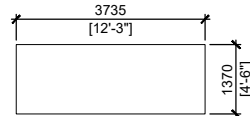

dining table 12 people (1 large table)

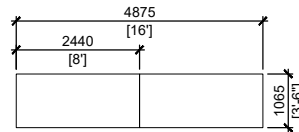

dining table 12 people (2 small tables)

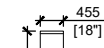

dining chair

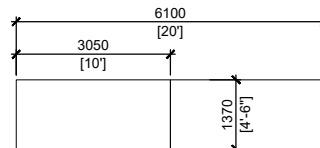

dining table 18 people (2 tables)

### 2 truck options

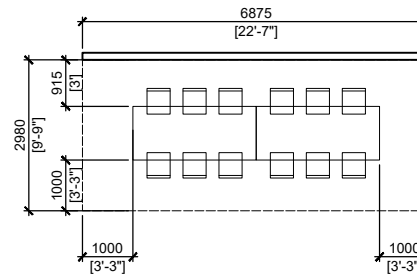
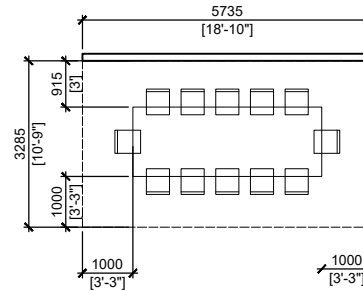

### 3 truck options

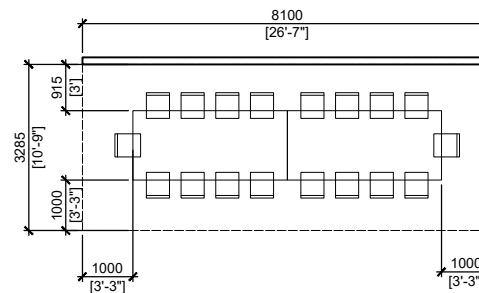

### Outdoor Area

- Outdoor area accessed off the kitchen/dining;
- to accommodate 1 barbecue grill with a gas connection;
- and to have seating for 8-10 people
- provide architecture fencing around outdoor area for privacy and separation

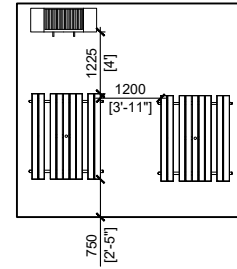
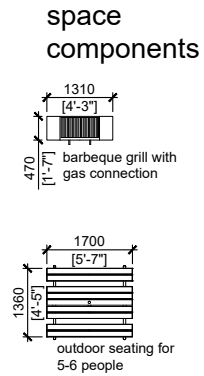

### Gym / Workout Area

- Gym / workout area large enough to accommodate equipment and 5 staff
- Final equipment list: to be coordinated with MFES.
- Approximate area = 30 sqm for a 2 truck station  
= 45 sqm for a 3 truck station

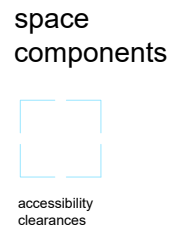

#### 2 truck options

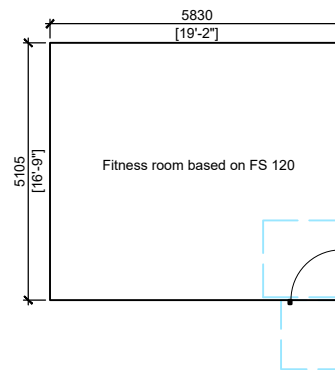

#### 3 truck options

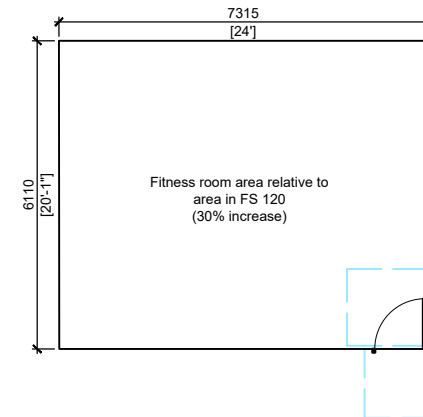

## Apparatus Bay

- All apparatus bays to be designed to aerial fire truck specification.
- Bay length to support an additional support vehicle parked behind the fire truck.
- Trucks to drive in and out of apparatus bays rather than back in
- Apparatus bay door width to be roll up vs folding doors, and to measure a min 4270W x 4270H.
- Card access on front and back man+ O/H doors
- Garage door openers on truck (remote controlled)
- Infrared heating system to be full length of apparatus bay.
- Emergency Vehicle Exhaust Capture System with a rail the full length of the bay and with pull through capabilities
- Provide for air circulation in the summer through high level fans of high level windows. If fans are provided, they should be caged.
- Two Overhead power outlets.
- Design a breakaway electrical outlet in the bays that will cleanly break away from the fire truck when the fire truck is plugged in and needs to pull out quickly for a call.
- Eyewash station to be accommodated in apparatus bay. Its location to not impede on entrance/ exit from trucks.
- Green push buttons to be provided at the bay doors where trucks exit. These tie into the traffic signal box to stop pedestrian traffic and to ensure it is safe for the truck to go.
- Stove off push button to be provided in the access from the living area to the apparatus bay.
- A push button to be provided once inside the bay area to acknowledge the call.
- Provide writable and tackable surfaces in apparatus bay.

**Mobile hose rack for drying is preferred.** However, if the Hose tower for drying is chosen for a design the following criteria should be met:

- Anchorage points for training within tower for each station
- Provide enough room for multiple hoses (1-10). At minimum enough room for drying 1 hose/ truck and for storing 1 hose/2 trucks
- Tower staircase measures 32" wide with 11" deep x 7" high stair treads
- Tower height to be 34'
- Tower to include 24 hose hanging point at 27' off the finished floor
- The hose tower will also be the location for roof access

space  
component:

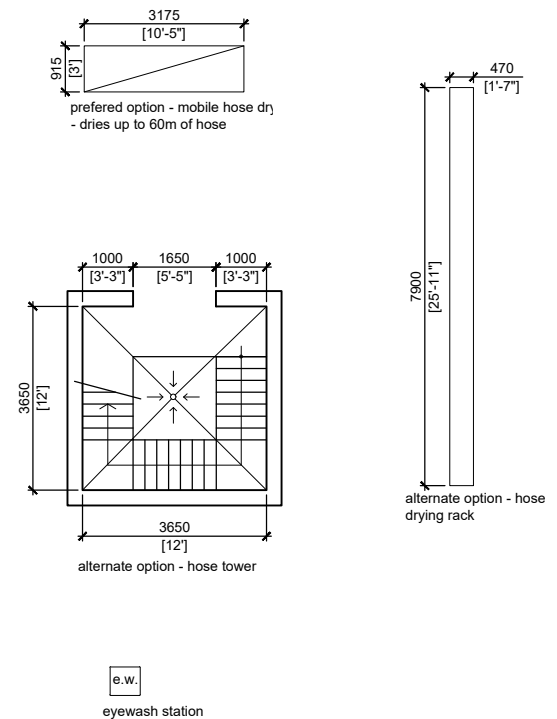

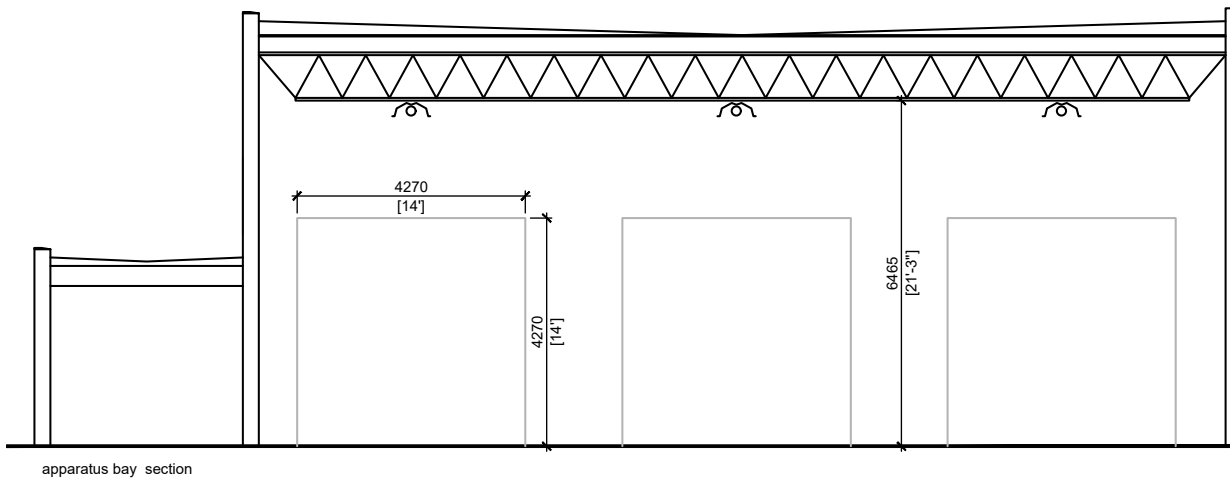
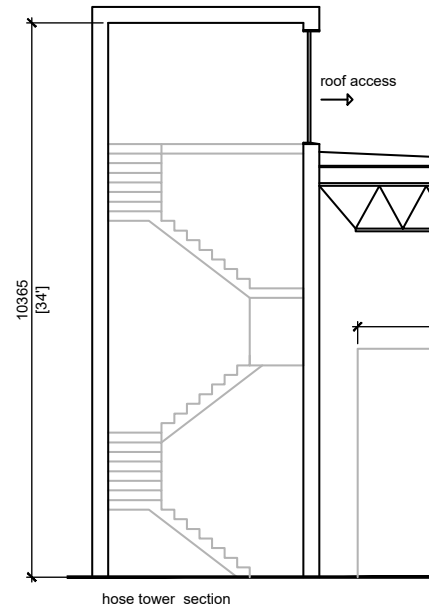
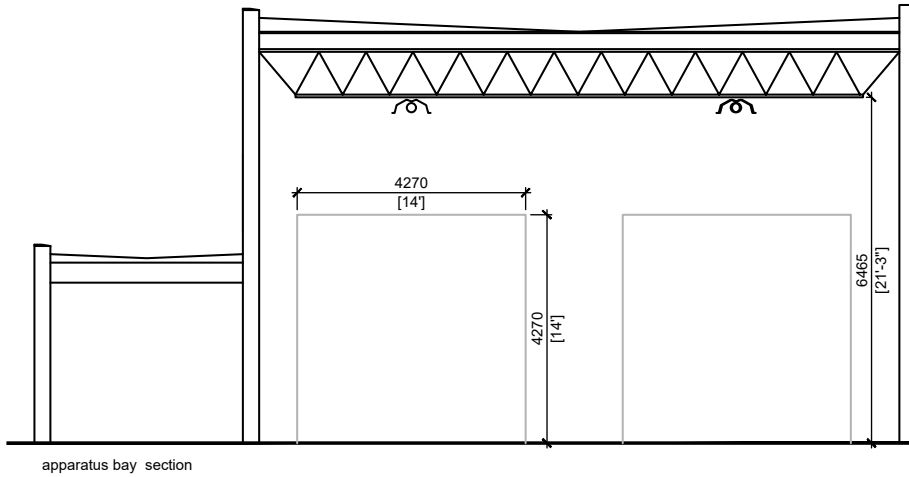

2 truck configuration options

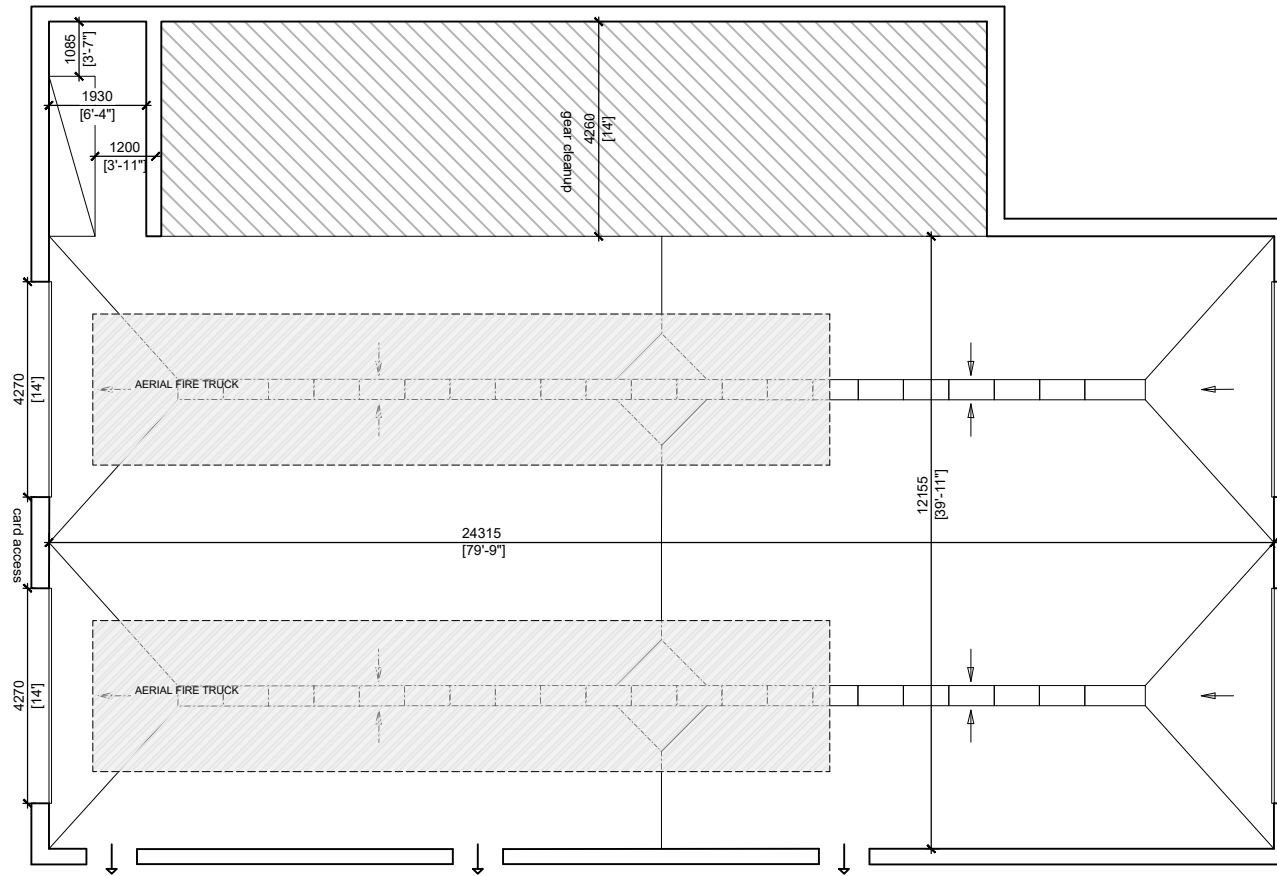

A  
Apparatus bays with mobile hose drying rack

2 truck configuration options

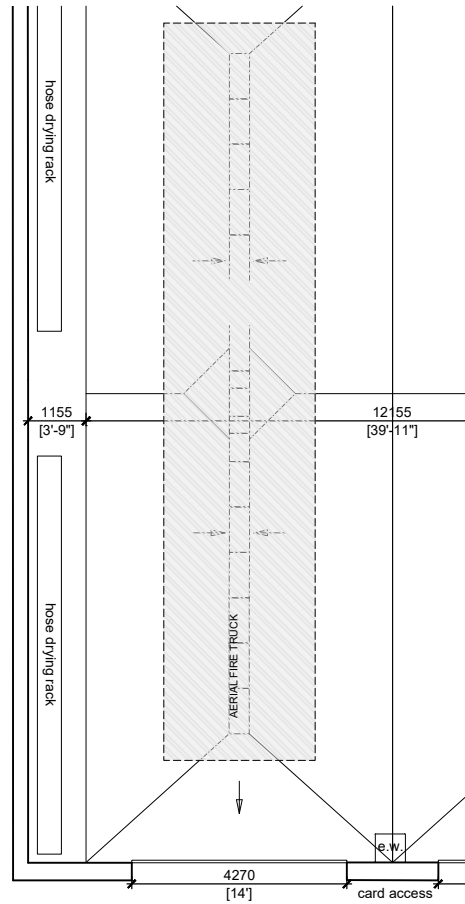

**B**  
Apparatus bays with hose drying racks

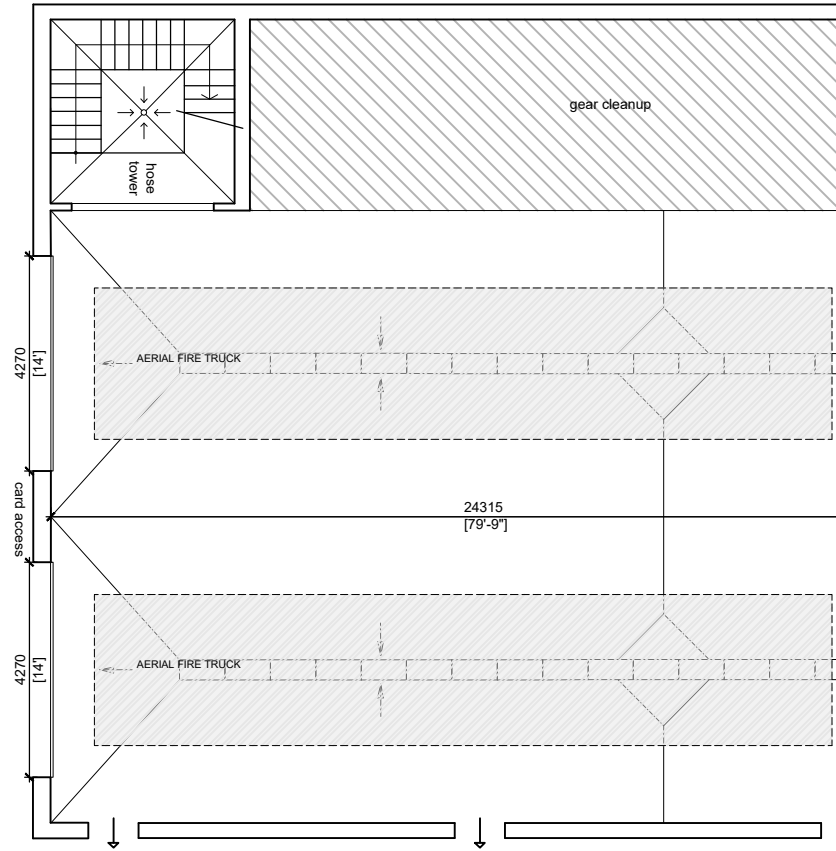

**C**  
Apparatus bays with hose tower



### 3 truck configuration options

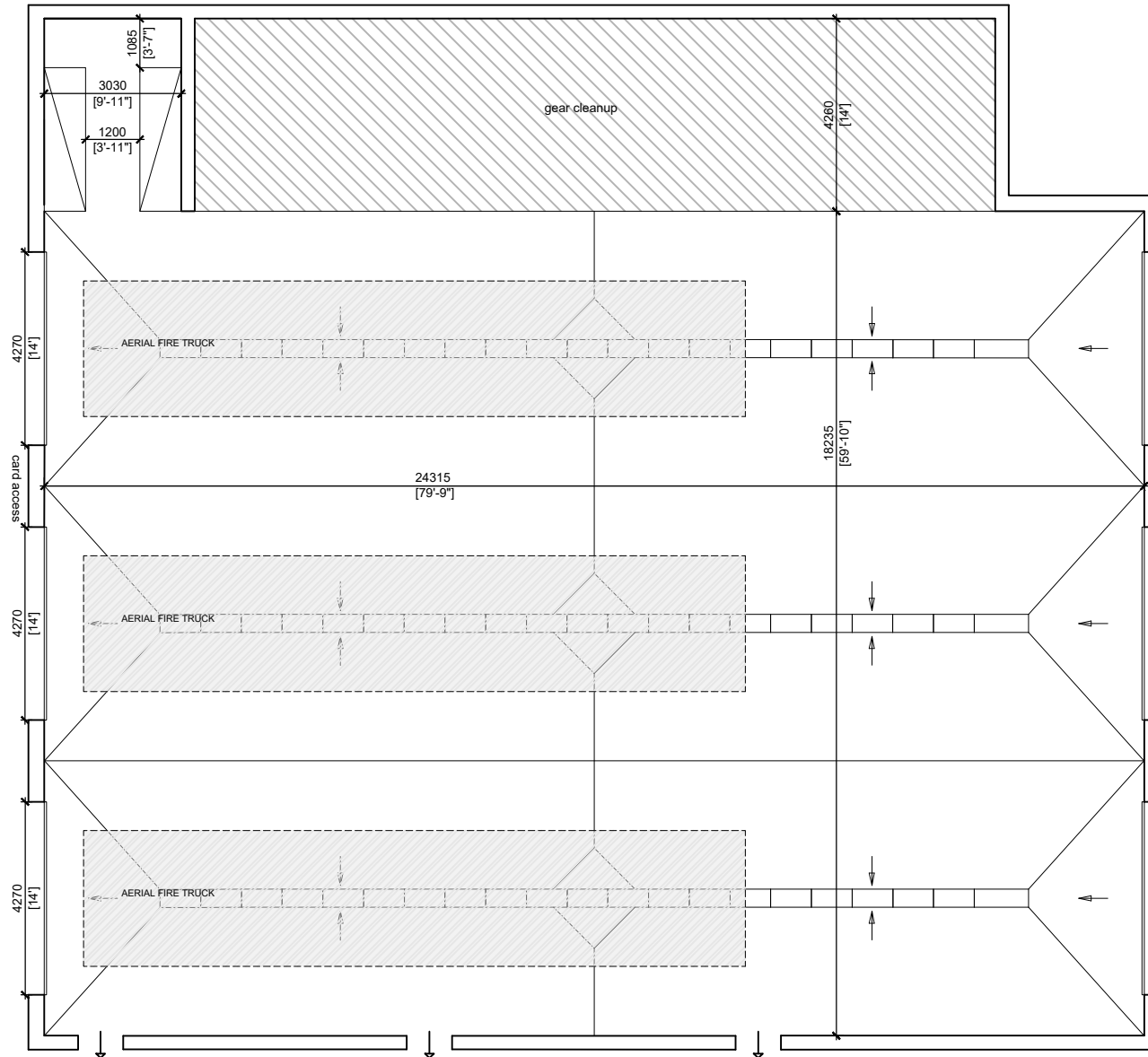

A  
Apparatus bays with mobile hose drying racks

3 truck configuration options

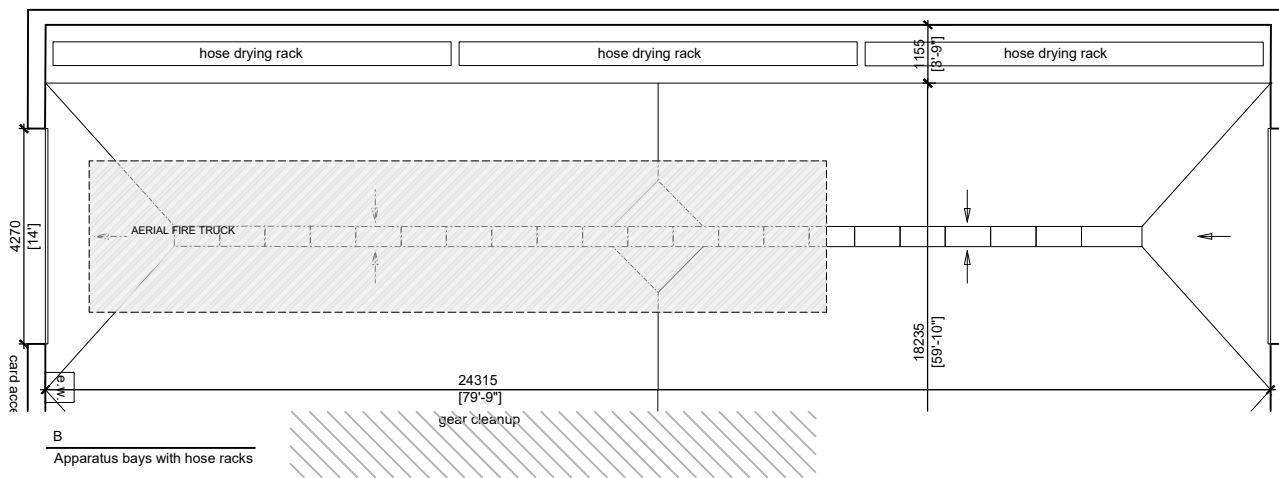
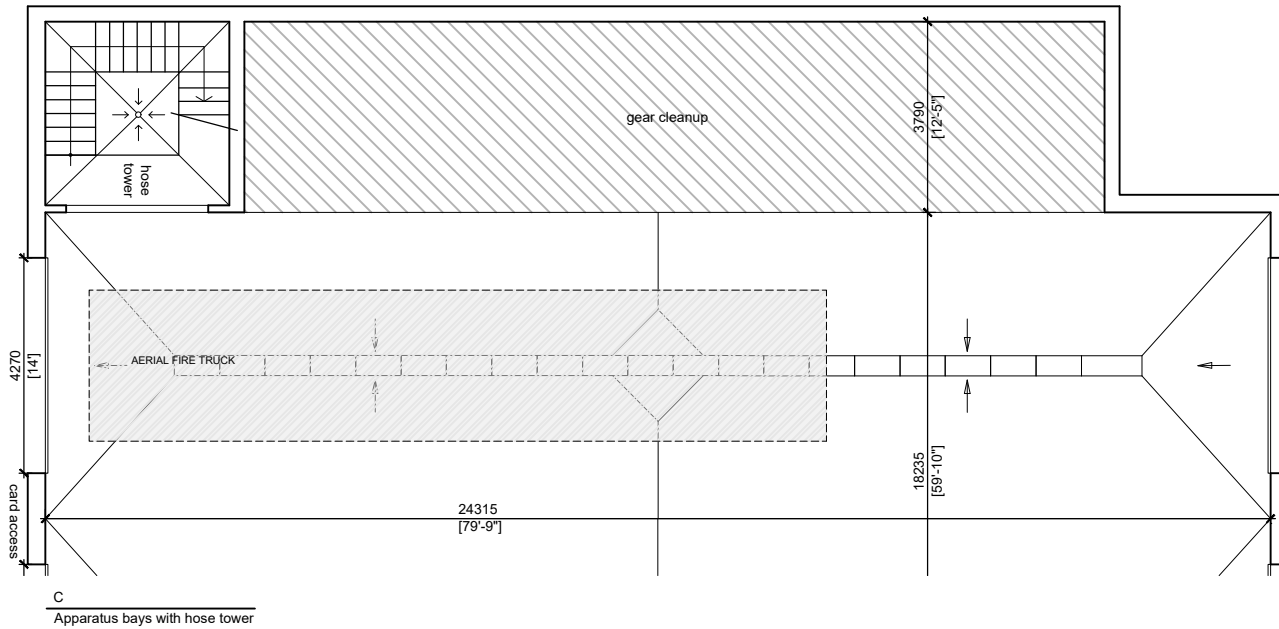

## Bunker Gear Room

- Self-contained Bunker Gear Room complete with recirculation system.
- Combination of wall mounted and mobile racks. Racking system to accommodate minimum of:
  - 40 racks at 24"x24" for a 2 truck station.
  - 50 racks at 24"x24" for a 3 truck station.
- Bunker gear room to accessible from apparatus bays
- Floor drains to be provided in the room.

2 truck configuration options

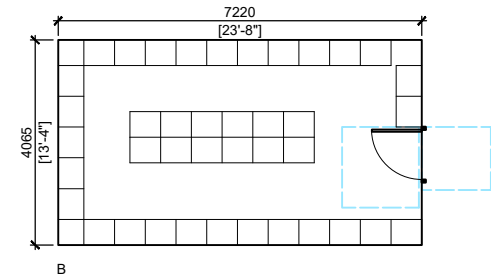
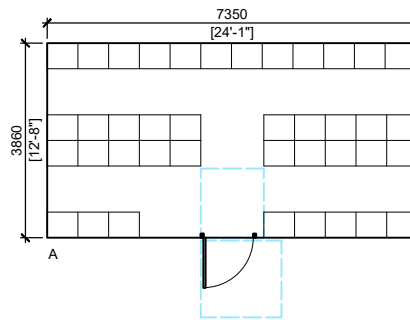

### space components

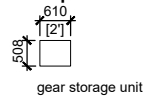

accessibility clearances

3 truck configuration options

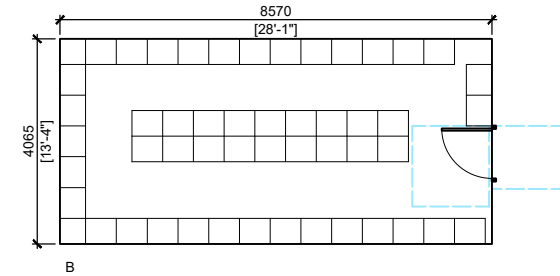
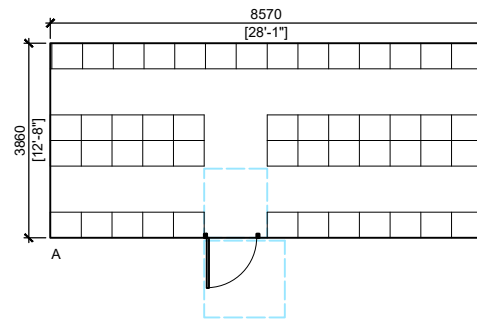

## Gear washer / Dryer / Laundry Room / Shop

- Room in an area accessible from apparatus bay
- Contains Unimac gear extractor equipment and the support system infrastructure
- 1 gear drying rack/ truck.
- The gear extractor to be designed with a support slab that is raised
- The gear extractor drains very quickly, requiring a sufficient size drain.
- Provide sufficient room to store the laundry detergent jugs and cleaning supplies.
- Provide Stacked Washer & Dryer
- Provide 1 work bench, wall tool storage, 1 storage cabinet, and a sink for washing face pieces

### space components

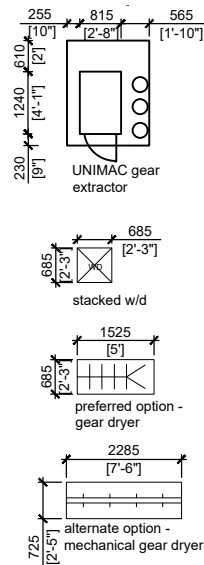

### 2 truck options

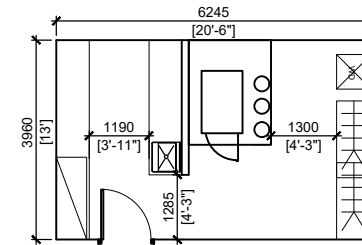

### 3 truck options

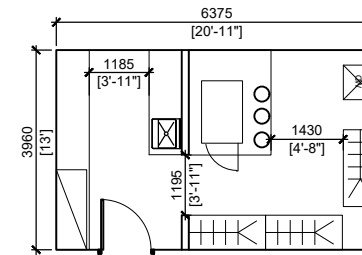

## Material Storage Room

- A nook that directly opens onto the apparatus bay
- The space should accommodate a standard (48"x40") pallet with clearances
- The nook should be placed closer to the rear bay door access point for material loading.

## Compressor Room

- A 3.6 x 3.6 metre room for the compressor, air regulator chamber with fill stations, cascade bottles and bottle storage racks

## Support Spaces

### Mechanical Room

- Rooftop units preferable to free up floor space.
- Provide sufficient ventilation for mechanical room.
- Mechanical room within the floor area to accommodate central vacuum and a hot water tank.
- Should accommodate a double door.
- The domestic hot water tank needs to have sufficient capacity to supply the equipment commercial washing machine.
- Recirculation pump to be accommodated within this room.

### mechanical room space components

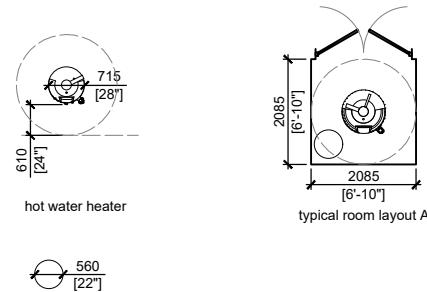

### Electrical Room

- Electrical room approximate area to be 10 sqm with minimum room width of 1600mm for equipment clearances.
- ASCO automatic transfer switch is preferred.
- Room to accommodate a compressor requiring a 305x305mm area.
- Room to house controller for exterior pylon sign.
- Electrical room to be positioned along the building perimeter as close as possible to the proposed transformer location to reduce conduit runs.

### electrical room space components

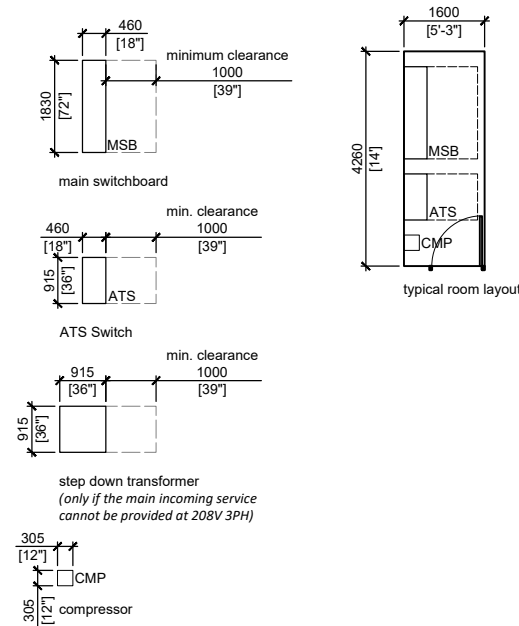

### IT Room

- IT room to be provided to house servers.
- Provide adequate cooling in this room.
- Locate centrally on the plan ideally.

### IT room space components

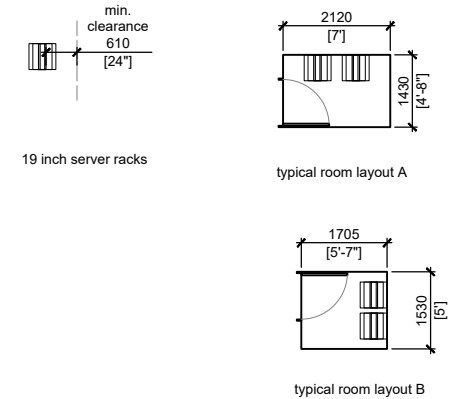

## Support Spaces

### Storage Room

- Provide a general storage space.
- A separate first aid supply storage to be accommodated.

### Janitor Room

- Janitor room to include a slop sink.
- If area allows, 2 janitor rooms are preferred (one on the hot side and one on the cold side)

### Outdoor Storage Room

- Room either within envelope or stand alone for storage that can accommodate a snow blower, 2 lawn mowers, a weed whacker, and a rack of misc tools
- Outdoor storage room to be provided with outdoor access
- Can be combined with sprinkler room
- Positioned towards the rear of the building preferably
- May store combustibles

### Sprinkler Room

- Room to accommodate incoming fire pipes
- Direct Access to the outside closest to the street edge

## Critical equipment & systems:

### Generator

All stations require a full back up generator on site external to the building footprint  
Natural gas generator in accordance with applicable codes, rules & regulations including TSSA requirements.

### Signage:

All stations to include exterior pylon sign. Refer to City of Mississauga standard pylon sign design.

## Waste Management:

An exterior enclosure to accommodate 4 large recycling blue bins and 4 large garbage blue bins per the Peel Region standard cart sizes.

## Parking

- Minimum Parking:
  - 22 spaces (1 barrier free) for 2 truck stations
  - 32 spaces (2 barrier free) for 3 truck stations
- Barrier free parking spaces within 30m of entrance.
- Parking requirements to meet City of Mississauga standards
- Provide electric vehicles' charging station and the system infrastructure in support thereof

### parking stalls

per City of Mississauga Parking, Loading and Stacking Lane Regulations

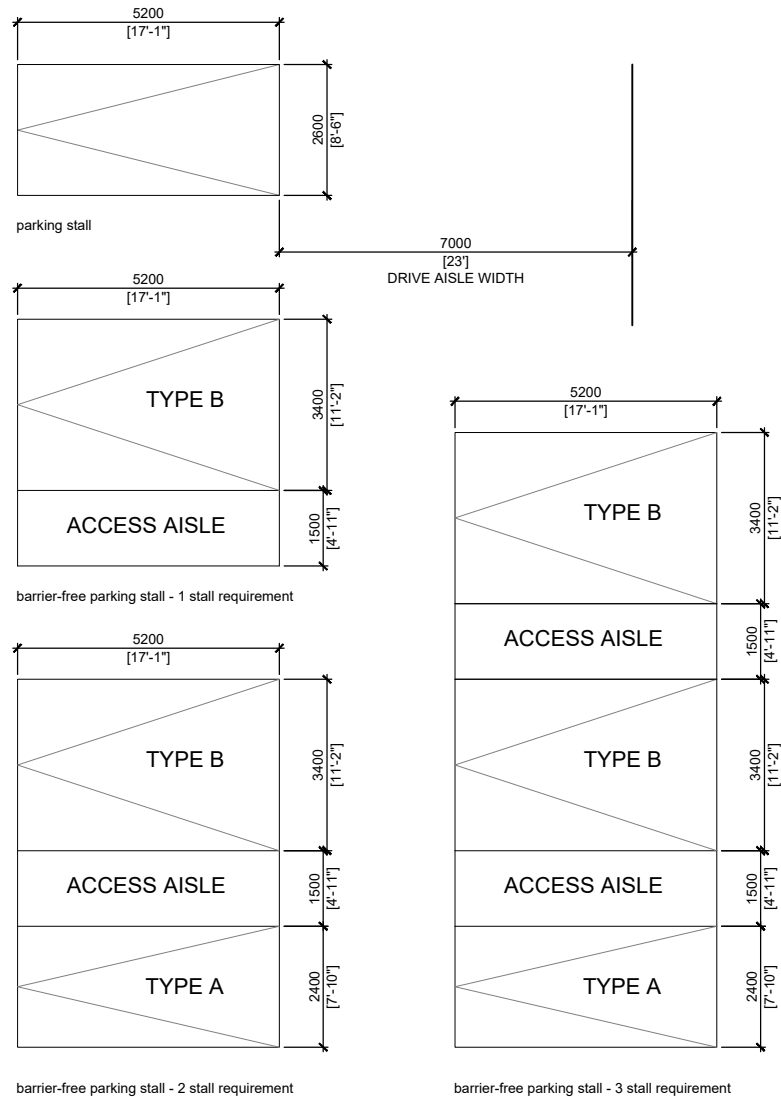

## Fire Truck Maneuvering

Fire trucks should have enough maneuvering space to be able to access the apparatus bays from the rear and exit from the front directly onto the road.

The current standard aerial fire truck turning radius is shown here. Consultants should obtain the full specification sheet from the City of Mississauga Fire and Emergency Service at the time of design.



## Turning Performance Analysis

**Bid Number:** 690  
**Department:** Mississauga Fire and Emergency Services

**Chassis:** Arrow XT Chassis, PAP/Midmount  
**Body:** Aerial, Platform 100', Alum Body

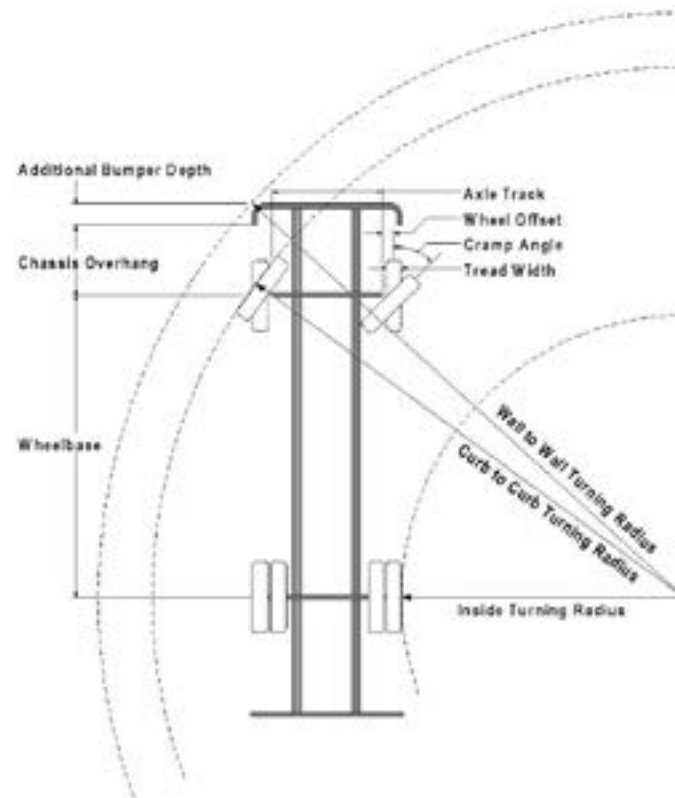

### Parameters:

*Inside Cramp Angle:	42°
Axle Track:	81.92 in.
Wheel Offset:	5.3 in.
Tread Width:	17.7 in.
Chassis Overhang:	68.99 in.
Additional Bumper Depth:	19 in.
Front Overhang:	140.1 in.
Wheelbase:	263.5 in.

### Calculated Turning Radii:

Inside Turn:	23 ft. 4 in.
Curb to curb:	39 ft. 6 in.
Wall to wall:	46 ft. 10 in.



## 2.2 fire station design principles

### Spatial Relationships

A fire station supports both the needs of the fire department and the community. It must house diverse functions, which includes sleeping facilities, recreation, administration, training, community education, equipment and vehicle storage and maintenance, and hazardous materials storage. While it is usually only occupied by trained personnel, the facility may even need to accommodate the general public for community education or outreach programs occasionally.

### Cross contamination and Hot/Cold zones

Those on the front lines in any Fire and Rescue operation are at high risk of exposure to contaminants, carcinogens, and other hazardous and dangerous substances. These substances are often brought back into the Fire Station with contaminated equipment. The apparatus Bays and Maintenance zones that contain these contaminants are sometimes referred to as HOT zones. Containment and avoidance of cross contamination of “clean or COLD” zones in the station is one of the most important principles of fire station design.

*Contain the Contaminants: Crossover control between zones*

- Autonomy and self sufficiency of each zone to reduce requirement of crossover visits.
- Separate HVAC systems for each distinct zone to avoid air borne cross contamination.
- Design crossover areas with proper signage, hand sinks, sanitizers, and walk off floor mats.
- Positive air pressure must be maintained in the COLD zones.
- Consider separate janitors closets in each zone.
- Separate laundry facilities should be provided in both zones.

*PPE storage*

- Contaminated equipment should not be stored in open racks to avoid migration of contaminants.
- Exhaust this room directly through the roof, remote from any fresh air intakes.

### Quality of Life

Fire stations are usually occupied 24 hours a day, seven days a week by personnel in continuous 24-hour shifts. Often, personnel will spend long stretches of time in the station without a call. It is imperative that a comfortable and supportive living environment be provided for the firefighters. Some of these principles include:

- Ample natural light
- Ensure dorm rooms are quiet and comfortable with privacy between beds
- If possible provide separate noisy recreation areas (such as a game room/kitchen) and quieter areas for reading, etc.
- Provide opportunities for exercise for firefighters

### Durability

Fire stations experience a high level of wear and tear due to their 24-hour occupancy and number of users. It is important that the construction materials and finishes are durable and long-lasting.

Fire stations are also typically cleaned by firefighters themselves, therefore finishes should be easy to clean and maintain. Finishes with rough textures that trap dirt should be avoided.

### Response Time

Fire station living areas should be designed to facilitate quick access to the apparatus bays. This should be done by minimizing travel distances to the bays and maintaining a clear path of travel free of obstructions and containing a minimal number of jog and turns.



## 2.3 adjacency diagram

one storey option

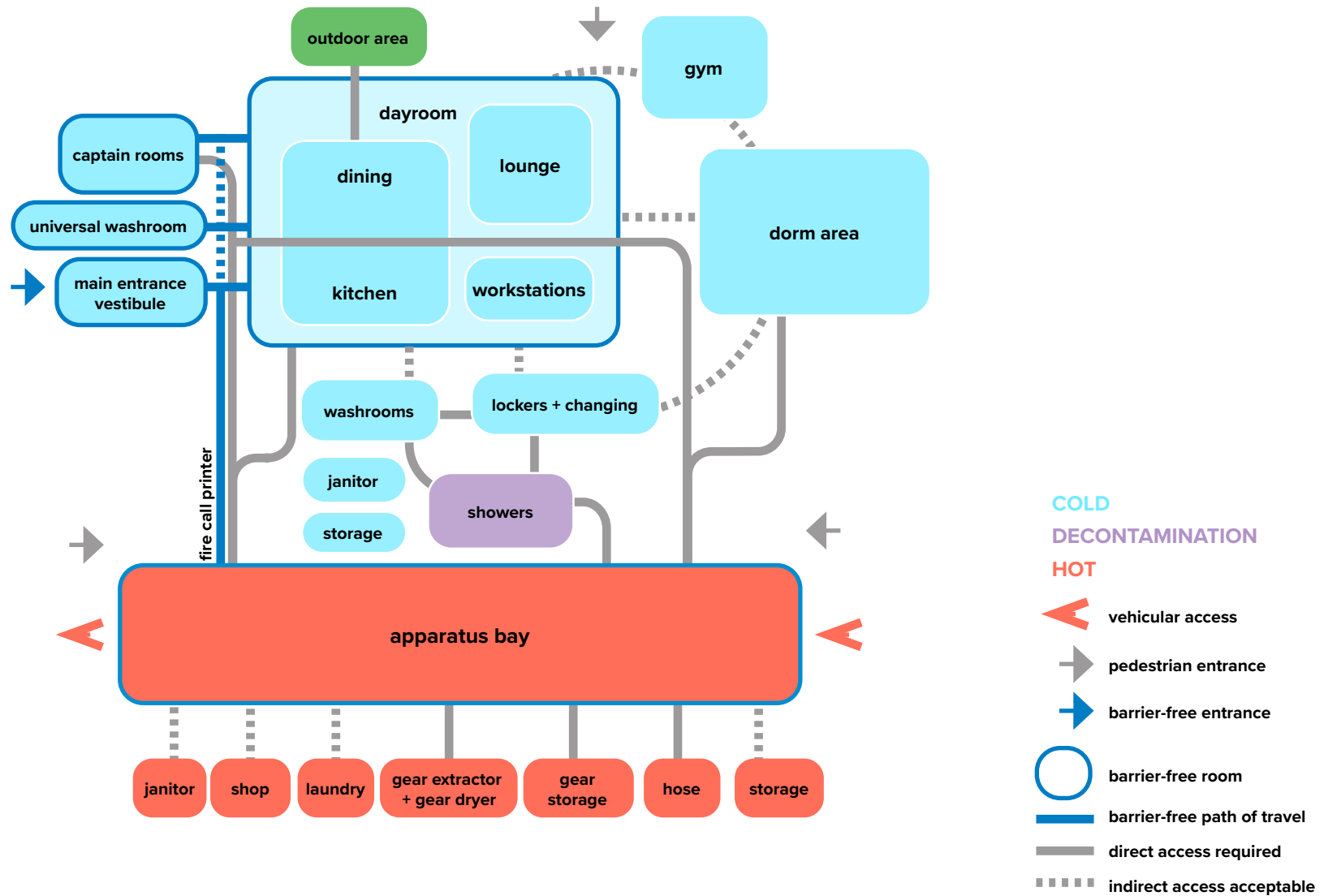

two storey option

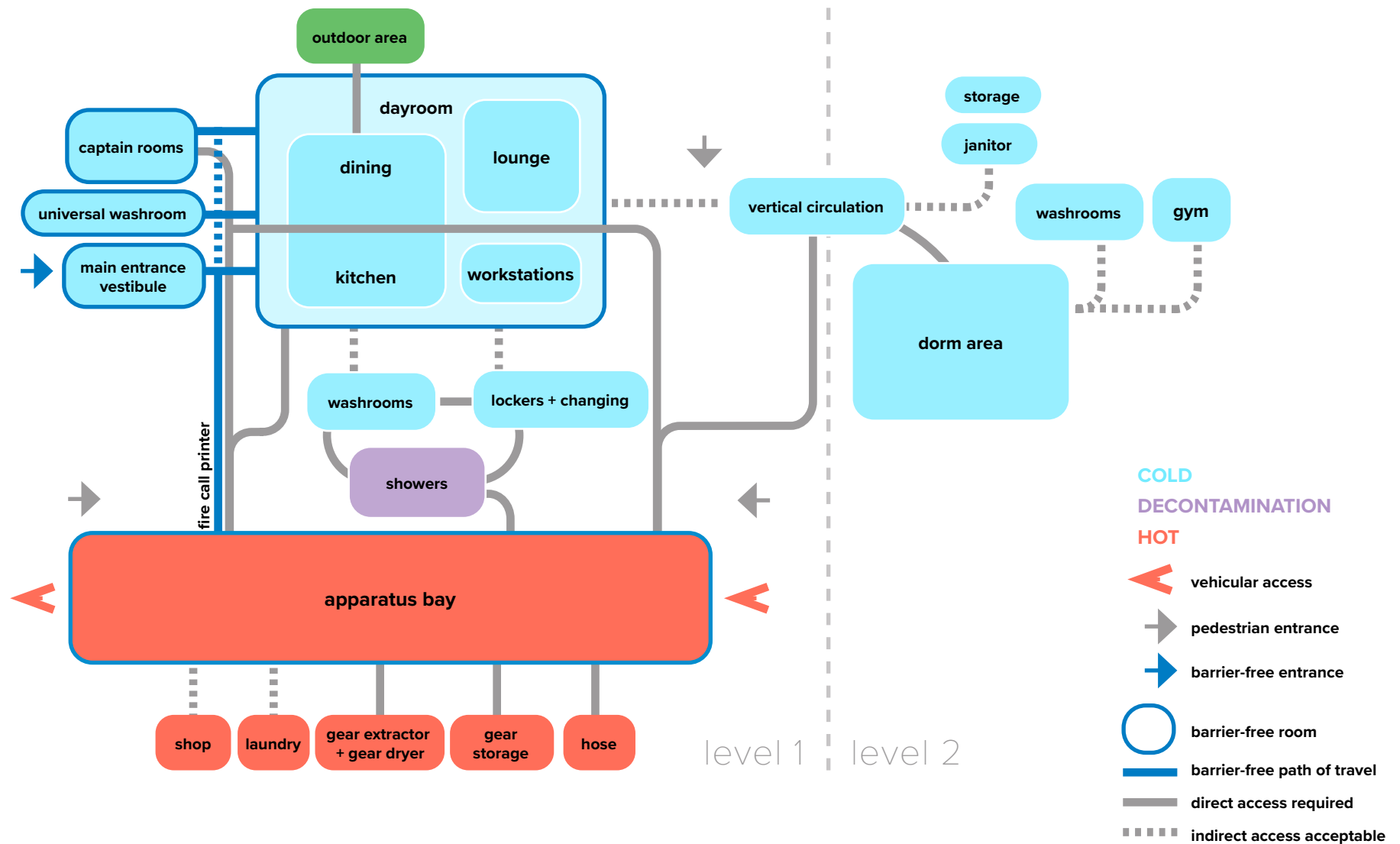

## 2.4 green design



Future fire stations should aim to meet the requirements identified in the City of Mississauga's (the City) Corporate Green Building (CGBS) Standard. The CGBS is a set of performance requirements that applies to new construction and major renovation in City-owned and operated buildings.

The intent of the CGBS is to promote environmentally, financially, and socially responsible practices in building design and construction. It is intended to be a standard and a guide for the City, design, and construction teams to deliver high-performance buildings with market-leading design, construction, and operations practices.

The CGBS Standard is organized into the following environmental performance areas: Energy and Climate Change, Materials, Transportation, Waste, Water, and Natural Heritage.

The Standard sets three increasing levels of performance that design teams can elect to pursue according to a specific project's characteristics and constraints:

**LEVEL 1:** This level sets the base performance targets that are required to be achieved in all new municipal buildings and facilities. New construction projects must achieve this minimum level of performance in all environmental performance areas.

**LEVEL 2:** This level represents a set of performance targets that have been identified as moderately more

ambitious than Level 1, and that should be considered as highly desirable by the City of Mississauga. They represent a higher level of performance than Level 1 that should be considered in design.

**LEVEL 3:** This level outlines a set of environmental performance targets that are considered "best in class" and that should be pursued wherever project parameters allow. Applicants should note that the achievement of the International Living Future Institute's Living Building Challenge and/or any relevant petals should be considered an alternative compliance pathway for Level 3.

The following green design brief directly responds to the CGBS requirements outlined in each area for each level with further detailed recommendations specific to fire station design. However, during design development, it is recommended that the prime consultant also refer to the CGBS Standard for a detailed list of requirements at each level.

The City of Mississauga also requires base case modeling in addition to the energy modeling required to achieve the CGBS. The base case model is intended to measure building performance as if no CGBS strategies are implemented. This comparison will help assess the effectiveness of CGBS and inform the savings associated with implementing CGBS.

### 1. Energy and Climate Change

#### 1.1 Energy and Emissions Performance

The overall building design should achieve the Energy Use Intensity (EUI), Thermal Energy Demand Intensity (TEDI), and Greenhouse Gas Intensity (GHGI) targets on each level. These targets will have to be confirmed through energy modeling at two stages: Site Plan Approval and As-Built Stage.

Level 1	Level 2	Level 3
<b>EUI:</b> 105 kWh/m <sup>2</sup> /yr	<b>EUI:</b> 80kWh/m <sup>2</sup> /yr	<b>EUI:</b> 60kWh/m <sup>2</sup> /yr
<b>TEDI:</b> 75 kWh/m <sup>2</sup> /yr	<b>TEDI:</b> 60 kWh/m <sup>2</sup> /yr	<b>TEDI:</b> 30kWh/m <sup>2</sup> /yr
<b>GHGI:</b> 11 kgCO <sub>2</sub> e/m <sup>2</sup> /yr	<b>GHGI:</b> 5 kgCO <sub>2</sub> e/m <sup>2</sup> /yr	<b>GHGI:</b> 5 kgCO <sub>2</sub> e/m <sup>2</sup> /yr

The energy of building performance targets should first and foremost be achieved through high quality envelope design and equipment selection along with the utilization of renewable energy sources. While a wealth of systems, equipment and technologies are available to achieve a green building, focusing on "simpler" systems that are designed for long operational life and lower maintenance costs will be the most successful and future proof.

In the design of fire halls it is important to note the two occupancies (living areas vs apparatus bays) of this building type. These occupancies have different operations and functions which require different energy consumption levels and are subject to very different environmental stresses.

It is recommended that when designing fire halls to establish higher performance levels for the living areas than the apparatus bays.

#### *envelope design:*

A building's energy consumption is highly reliant on the quality of its building envelope. The building envelope should be designed with high thermal and moisture control by designing in continuous thick insulation, air tight construction, reduced thermal bridges and careful vapour control. These passive elements will reduce the reliance on HVAC systems and thereby reduce power

consumption.

The building should also be designed with ample natural light through the placement of well oriented windows. This reduces the reliance on electrical lighting systems in the design.

Windows however can be a major source of heat loss, therefore it is important to select highly performing insulated glazing units, with triple glazed units being our recommendation. Window frames also constitute a major point of thermal bridging and a point of condensation. Therefore, it is recommended that window frames be detailed to be thermally broken from the structure. Consider PVC window head and sill flashing to reduce thermal bridging. It is also recommended to maximize the glass and minimize frames so designing in larger but fewer windows is preferable from a thermal bridging perspective.

Windows also serve an avenue for heat gain that could aid in the heating season. Southern facing windows are great to aid in heating in the winter season and can be easily shaded with overhangs to reduce heat gain in the cooling seasons. East/West oriented buildings are harder to control in terms of overheating, so employing deciduous vegetation for window shading in the summer and heat gain in the winter is recommended.

#### *mechanical design:*

**Level 1** – Detailed mechanical energy usage calculations shall be performed during detailed design through energy modeling. To achieve the required Level 1 parameters, the mechanical design shall incorporate the use of high efficiency gas-fired heaters and air conditioners and adherence with ASHRAE SB-10 and OBC energy requirements. In addition, energy recovery units with above 70% efficiency shall be specified for all ventilation related designs. Condensing domestic water heater or multiple instantaneous water heater should be considered. Standard SB-10 compliant HVAC and hot water heating equipment selection is also anticipated to help the overall design in achieving the Level 1 requirements. The requirements of Level 1 is to exceed

the SB-10 requirements by at least 35%. Provisions to achieve these requirements will not lead to significant higher equipment costs. A possible 10-15% increase in price as compared to the standard efficiency units.

**Level 2** – Even higher efficiency HVAC and hot water heating equipment alongside more sophisticated building automation controls are anticipated for helping to achieve Level 2 compliance. This may include energy recovery units (ERVs), domestic water and building drain piping heat recovery systems and solar energy electronic flush plumbing fixtures. Further coordination for mechanical HVAC control systems with electrical discipline is anticipated in order to control fan speed and ventilation requirements depending on occupancy. Provisions to achieve these requirements is anticipated to increase the mechanical budget by approximately 40-60%.

**Level 3** - This Level requires a reducing in overall energy usage of 45% over and above Level 1. A mechanical HVAC system consisting of geothermal heating and cooling and centralized exhaust system and ventilation system by means of a custom make-up air with an ERVs may be required to achieve this level.

Geothermal wells beneath the ground take advantage of the earth's stable temperatures. Water with glycol mixture is circulated through pipes extending into the ground to extract or discharge heat to efficiently warm and cool the building.

A high-efficiency ERV system captures and reuses 75% of the exhaust heat that would otherwise be lost from the building. This along with the highest efficiency heat pumps on the market, and gas fired equipment for supplementary heat and domestic hot water heating will help contribute to a level 3 compliant design.

Consideration for a hybrid heat pump packaged rooftop unit with supplementary gas-fired heating and fully modulating compressor to provide exact heating and cooling with highest efficiency. The supply fan and condenser fan should both be with electronically commutated motor (ECM) also known as VFD motors.

Where possible, RTU should also incorporate a packaged ERV add on.

A hydronic water heating system installed on the roof can be used to preheat domestic water along with high efficiency boilers complete with ECM motor pumps will help add solar heating to the DHW system.

Using multiple units for improved zoning and temperature control will lead more energy efficiency.

Provisions listed here to achieve these requirements is anticipated to increase the mechanical budget by approximately 150%.

#### *electrical design:*

**Level 1** – Detailed electrical energy usage calculations shall be performed during detailed design through energy modeling. To achieve the required Level 1 parameters above, the electrical design shall incorporate the use of low energy LED light fixtures and adherence with ASHRAE SB-10 and OBC energy requirements. Standard SB-10 compliant lighting control design is also anticipated to help the overall design in achieving the Level 1 requirements. Provisions to achieve these requirements is anticipated to increase the lighting and load control budget by 25%.

**Level 2** – More sophisticated lighting controls are anticipated for helping to achieve Level 2 compliance. This may include day light sensing and lighting control, auto dimming for perimeter lighting and adding occupancy sensor zoning above and beyond SB-10 requirements. Further coordination with mechanical HVAC control systems is anticipated in order to control fan speed and ventilation requirements depending on occupancy. Provisions to achieve these requirements is anticipated to increase the lighting and load control budget by 50%.

**Level 3** – This Level requires a reducing in overall energy usage of 45% over and above Level 1. A DALI lighting system may need to be incorporated in order to help achieve these levels. Switching off of non-essential power loads through sensors, timers, occupancy

sensors, etc. may also need to be implemented. Integration of all HVAC, plumbing and electrical systems and the provisions of a sophisticated BAS system may also need to be implemented to achieve this rating. Once energy modeling is performed, a more detailed list of deliverables can be provided for achieving Level 3 performance. Provisions to achieve these requirements is anticipated to increase the lighting and load control budget by 100%.

## 1.2 Building Commissioning

Building commissioning ensures that all systems and components of a building are designed, installed, tested, operated, and maintained according to its operational requirements in an optimized manner.

### *mechanical commissioning:*

Monitoring-based Commissioning: Develop monitoring-based procedures and identify points to be measured and evaluated to assess performance of the major energy-consuming systems representing more than 10% of the building's total energy use (at a minimum heating, cooling, lighting, fans, and pumps).

**Level 1** – This level of commissioning requires Monitoring-based Commissioning including but not limited to:

- i. Commissioning Plan
- ii. Commissioning Report
- iii. Current Facilities Requirements and Operations and Maintenance Plan

Mechanical equipment and related systems that will be included in the commissioning plan includes but is not limited to:

- i. Hot water heaters (gas fired & Solar)
- ii. Plumbing fixtures
- iii. Energy recovery units (air and water)

- iv. Air handling units (heat pumps, packaged RTU's, fans)
- v. Geothermal loop
- vi. Building automation System (BAS)
- vii. Pumps

Level 1 commissioning will add a 15% cost to the overall mechanical budget compared with a package where no documented commissioning is required

**Level 2** – This level includes all requirements of level 1 with the addition of the following:

- System operational manual.

Level 2 commissioning cost increase as it relates to Level 1 will be 20-30% higher.

**Level 3** – As it relates to mechanical systems this level is not applicable.

### *electrical commissioning:*

Monitoring-based Commissioning: Develop monitoring-based procedures and identify points to be measured and evaluated to assess performance of the major energy-consuming systems representing more than 10% of the building's total energy use (at a minimum heating, cooling, lighting, fans, and pumps).

**Level 1** – This level of commissioning requires Monitoring-based Commissioning including but not limited to:

- Commissioning Plan
- Commissioning Report
- Current Facilities Requirements and Operations and Maintenance Plan

Electrical equipment and related systems that will be included in the commissioning plan includes but is not limited to:

- Lighting systems
- Lighting control systems

- Power distribution equipment
- Generator
- Fire alarm system (as required)
- Door access control
- Security systems

Level 1 commissioning will add a 10% cost to the overall electrical budget compared with a package where no documented commissioning is required.

**Level 2** – This level includes all requirements of level 1 with the addition of the following:

- System operational manual.

Level 2 commissioning cost increase as it relates to Level 1 will be negligible.

**Level 3** – As it relates to electrical systems this level is not applicable.

### *envelope commissioning:*

The CGB standard identifies the requirement for building envelope commissioning for a Level 3 performance standard.

Building envelope commissioning (BECx) differs from electrical and mechanical commissioning in the fact that it should be implemented earlier in the design and construction process. The critical parts of a building envelope are usually hidden behind exterior cladding and interior finishes, therefore commissioning cannot be left to the end of the project because it would be hard to identify any problems and very costly to fix them. It is best for BECx to be developed early at the conceptual design phase and implemented at each stage of the design, construction, and occupancy phases. Early in the design phase it is recommended to retain a Building Envelope Commissioning Authority (BECA) to conduct 3rd party peer reviews throughout the process and identify critical elements to be commissioned and key points for design and construction reviews.



### 1.3 On-Site Renewables

On-site energy generation is encouraged where possible, using renewable energy sources to reduce GHG emissions associated with building operation, as well as to reduce stresses imposed on the local electricity grid and further improve building resilience in the wake of power outages.

#### *mechanical design:*

On-site energy generation using renewable energy sources is encouraged to reduce GHG emissions associated with building operation, as well as to reduce stresses imposed on the local electricity grid and further improve building resilience in the wake of power outages.

**Level 1** – Domestic hot water hydronic heating systems can help achieve level 1 compliance. It shall be noted that typically these systems are located on roof spaces. Depending on renewable goals, a cost benefit analysis will be required to determine the most efficient use of roof space for achieving the renewable goals. Evaluating, Hydronic heating vs. Solar PV electrical generation in order to determine the best use of budgets, roof space etc. will determine which system (or perhaps a combination of both) can be implemented. A Solar Hydronic heating system will add 15% - 25% to the mechanical budget.

**Level 2** – For level 2, a geothermal system shall be considered. Geothermal wells beneath the ground take advantage of the earth's stable temperatures. Water with glycol mixture is circulated through pipes extending into the ground to extract or discharge heat to efficiently warm and cool the building. The cost of this system is anticipated to add a 50% increase to the entire

mechanical budget.

**Level 3** – This level is not possible with a mechanical renewable system. There is the option of adding solar panels to the rooftop units to reduce the energy cost. The unit's solar energy is first used to meeting the cooling/heating demand, when the cooling system is not operating, the system powers lighting, appliances and other electronic devices. The solar system is not capable of providing the fully power needed during peak demand and thus will need power connection to the building. Currently, there is nothing available in the market to completely make the mechanical system external energy independent.

#### *electrical design:*

On-site energy generation using renewable energy sources is encouraged to reduce GHG emissions associated with building operation, as well as to reduce stresses imposed on the local electricity grid and further improve building resilience in the wake of power outages.

**Level 1** – Designed to accommodate future installations of rooftop PV, including but not limited to structural capability to support rooftop PV, space available for future electrical equipment in electrical room, etc. Solar-ready provisions clearly identified in all applicable design documentation, and coordinated between the various design disciplines (electrical, structural, etc.). Provisions of the system will be designed to produce energy equivalent to 5% of the building's annual consumption. The system will be designed such that future PV panels can be installed and connected at a later date. A Net Metering connection is recommended where the PV system shall feed power directly back to the utility grid offsetting actual consumption of the facility. Anticipated

costs for a system such as this (not including structural improvements) is \$3 per watt (of the proposed system) for the electrical infrastructure only.

**Level 2** – This level requires actual functional installation of on-site renewable energy devices to offset 5% of building annual energy consumption. All applicable documentation to facilitate the design, installation, operation and maintenance of the renewable energy system (drawings, specifications, maintenance manuals, etc.) shall be produced. Supporting renewable energy analysis calculations to demonstrate that the 5% requirement has been met will be provided. Roof top solar PV is considered the best option for achieving this goal. The cost of this system is anticipated to be \$8 per watt not including structural improvements.

**Level 3** – This level requires actual functional installation of on-site renewable energy devices to offset 100% of building annual energy consumption. All applicable documentation to facilitate the design, installation, operation and maintenance of the renewable energy system (drawings, specifications, maintenance manuals, etc.) shall be provided. Supporting renewable energy analysis calculations to demonstrate that net zero energy has been met shall be provided. PV is still the most suitable system for achieving this goal for a fire station. Bio-gas, bio-fuel and wind are not really viable for this type of building. The limiting factor will be area (available suitable roof space). A detailed roof study will be required during detailed design. Average cost per watt for a system of this size will be reduced. The cost of this system is anticipated to be \$5 to \$6 per watt not including structural improvements. However, the overall cost of the system will 10-15 x





## 1.4 Air Tightness

Air tightness ensures that the air barrier systems of building envelope systems are constructed and performing as per design intent, given its significant influence on the overall energy and thermal performance of the building.

One of the main reasons for achieving air tightness in a construction is comfort and health. Airtightness is important to prevent condensation within wall assemblies which carries a high risk of mould growth and its associated health implications.

Indoor air quality is another important aspect of airtightness. Traditionally, buildings have been designed and constructed with interrupted air barriers. This causes a significant source of indoor air to be air passing through toxic building envelope layers.

Air tightness also prevents drafts and cold floor and wall surfaces which have a direct impact on comfort levels of occupants.

Air tightness improves insulation effectiveness, reduces ventilation heat losses, and improves the effectiveness of ventilation systems. This has direct implications on the design of HVAC equipment and carries the potential to significantly reduce heating load requirements and thereby reducing HVAC equipment sizes along with their associated energy consumption.

Airtightness should be designed early in the design process. At the design stage the line of continuous air barrier should be clearly illustrated on plans and sections. Any potential interruptions in the air barrier should be detailed since air barriers are as strong as the weakest detail.

Air barrier location: Exterior air barrier is recommended to avoid the need for lapping and taping around floor/wall/roof connection points. The air barrier will have to be sturdy enough to withstand the elements. An exterior air barrier is harder to install on taller buildings. The location of the air barrier should be coordinated with the

location of the vapour barrier. For Interior air barriers, it is recommended to use an installation cavity to protect the barrier's continuity from penetrations through it due to conduit and other installations.

The GBC standard identifies that for all levels a whole-building air leakage test be conducted to improve the quality and air tightness of the building envelope. It states that Projects shall target a test pressure of 75Pa. Projects unable to achieve 75Pa must follow either ASTM W35913 alternative test methods, a Repeated Single-Point Test, or a Repeated Two-Point test and demonstrate compliance using projected curves for air tightness at 75Pa.

It is our further recommendation, especially for performance Levels 2 and 3, to do three blower door tests during construction. The first one after the installation of the air barrier, the second one after the installation of all mechanical systems and sealing of all penetrations, and a final one at the end of construction. We also recommend airtightness requirements meet the passive house standard minimum requirement of 0.6 air changes per hour @ 50Pa.

Fire stations apparatus bays should be designed to be outside the thermal envelope and be excluded from this airtightness requirement.

In a highly air tight building, mechanical ventilation become the main source of fresh air supply – besides operable windows which only supply outdoor air. Fresh air ventilators can improve air quality by exhausting stale dirty air and bring in filtered fresh air.



## 1.5 Metering and Benchmarking

The intent of this measure is to ensure that buildings are provided with an adequate level of metering and measurement systems to facilitate ongoing tracking of energy usage by the building systems.

*mechanical*

### All Levels

- Metering - Install electricity and / or thermal sub-meters for all energy end-uses that represent more than 10% of the building's total energy consumption. This shall include lighting panels, large HVAC equipment, large gas loads such as hot water tanks, infra-red tube heaters, etc. Provision of electricity and thermal sub-meters shall be clearly indicated on electrical single-line diagrams. A metering plan listing all meters along with type, energy source metered, diagrams, and/or references to design documentation shall be provided.
- Benchmarking - Register the building on ENERGY STAR Portfolio Manager and co-ordinate with the City of Mississauga Energy Management Team to establish the process for ongoing reporting and benchmarking.

- There will be a 2-3% increase to the mechanical construction cost and approximately additional 5-10% for building automation integration.

*electrical*

### All Levels

- Metering - Install electricity and / or thermal sub-meters for all energy end-uses that represent more than 10% of the building's total energy consumption. This shall include lighting panels, large HVAC equipment, large gas loads such as hot water tanks, infra-red tube heaters, etc. Provision of electricity and thermal sub-meters shall be clearly indicated on electrical single-line diagrams. A metering plan listing all meters along with type, energy source metered, diagrams, and/or references to design documentation shall be provided.
- Benchmarking - Register the building on ENERGY STAR Portfolio Manager and co-ordinate with the City of Mississauga Energy Management Team to establish the process for ongoing reporting and benchmarking.
- There will be a 5% increase to the overall electrical construction budget to facilitate this provision.

## 1.6 Resilience Performance Requirements

The intent of this measure is to promote buildings that are designed to maintain critical operations and functions in the face of a shock or stress, and quickly return to normal operations to maintain healthy, liveable spaces for its occupants.

*electrical*

**Level 1** - Provide 72 hours of back-up power and thermal energy to a central refuge area and to essential building systems as per the City's Minimum Backup Power Guidelines for MURBs. Combustion-based or battery-based systems are both permitted. A narrative describing the project's approach to resilience, with the back-up power source / quantity of fuel to be verified post construction. A natural gas generator providing full back up power to the facility will be installed at this facility. Natural gas has been the preferred fuel source for emergency generators in the GTA post 2003. The generator will be compliant with OBC, ESA, TSSA, NFPA and CSA standards. This will provide the requirements of this provision and the cost addition will be 0% beyond the planned provisions for emergency power.

**Level 2** - Only a non-combustion-based system using battery storage or other non-combustion forms of back-up generation is permitted. A battery back-up solution is not feasible for 72 hours of backup for this type of facility. This is due to the amount of storage required. The space and cost of implementing Level 2 is not considered feasible at this time due to limitations of existing battery technology.

**Level 3** – Not applicable.



## 2. Materials

### 2.1. Low-impact Materials

The intent of this measure is to encourage the use of environmentally preferable building materials, including those that are reused, recycled, and locally-sourced.

#### *Cement for Super Structure:*

##### **Level 1:**

Consideration should be given to replacing ordinary portland cement with 20% blast furnace slag, silica fume or fly ash. This involves the use of blended hydraulic cements, which often do not satisfy Class C1 and C2 requirements. They are acceptable for any slabs-on-grade supporting pedestrian traffic, but not heavy equipment or fire trucks. The proportioning and mixing of blended hydraulic cements are specified under ASTM C595.

Blended hydraulic cements produced from replacements exceeding 20% are generally not recommended for major structural components, because limiting the amount of ordinary portland cement can reduce the

reactive ingredient - Lime (CaO) – needed for hydration to occur. Blast furnace slag, silica fume and fly ash all have pozzolanic properties, allowing them to behave like portland cement; however, they are not recommended for footings, piers and suspended slabs.

##### **Level 2:**

For concrete components with replacements exceeding 20%, slag is considered the preferable pozzolanic replacement material. Type IS (25) slag-based cement could be used. It should be noted that air-entraining admixtures will be needed for all outdoor applications.

##### **Level 3:**

The following types of blend hydraulic cement are recognized and regulated by ASTM C595:

- Type IP cement is portland-pozzolan cement in which Ordinary Portland Cement (OPC) is mixed with a pozzolanic material, such as fly ash. (Replacement rates for type IP range from 15-25%.)
- Type IS cement is portland-slag cement in which ordinary portland cement (OPC) is blended with blast furnace slag in varying proportions ranging from

5-50%.

- Type IT cement is ternary cement consisting of ordinary portland cement blended with two different pozzolans, one of which is usually blast furnace slag. For example, Type IT (S25)(P15) is 60% OPC, 25% slag and 15% pozzolan (fly ash, silica, etc.).

In Ontario, most components require 5-8% entrained air; therefore, any air-entraining admixture must be compatible with the chosen hydraulic blended cement. As discussed previously, footings, piers and suspended slabs should be constructed of 35MPa Class C1 concrete made from ordinary Portland cement.

#### *Cement for Substructure / Foundations*

##### **Level 1:**

MM-1: Replace Ordinary Portland Cement (OPC) with 20% blast furnace slag, silica fume or fly ash. This involves the use of hydraulic cements, which often do not satisfy Class C1 and C2 requirements. This is acceptable for any slabs on grade supporting pedestrian traffic, but not heavy equipment or fire trucks.

##### **Level 2:**

MM-1: Type IS (25) Slag-based cement could be used for sidewalks and any interior slab-on-grade not required to resist the load of a fire truck or any heavy equipment. Blended cements must be compatible with the air-entraining admixture. In Ontario, concrete usually contains 5-8% air-entrainment to mitigate the problems that can arise from the freeze-thaw cycle.

**Level 3:**

MM-1: Refer to International Living Future Institute's Living Building Challenge. ASTM C595 governs the proportioning of blended hydraulic cement. Higher fraction replacements are used for non-structural components, sidewalks, curbs and interior slabs subject to standard occupant loads. The cements listed below the blended hydraulic cements in which ordinary Portland cement has been replaced with 40% pozzolanic material:

- Type IS (40)
- Type IT (S25) (P15)

*Wood:*

**Level 1:**

Use 25% FSC Certified Wood Products in construction. This is possible in many locations; however, it is recommended that the tower be constructed of steel.

**Level 2:**

Use 75% FSC Certified Wood Products in construction. This is suitable in many locations, with the exception of the tower, 2nd storey fitness centre and 2nd storey mechanical room. The 2nd storey fitness centre shall be built by using materials that limit the structural vibration. Structural steel and reinforced concrete are more suitable for this application. The 2nd storey mechanical room shall be built by using materials that can handle the weight of the mechanical equipment and machines. Wood products tend to be unsuitable to carry the machines' weight.

**Level 3:**

Satisfy the material requirements set out in the International Living Future Institute's Living Building Challenge. This may not be a practical alternative.

*Structural Steel*

**Level 1:**

The structural steel content must include 50% post-consumer recycled steel. Approximately 93% of structural steel is recycled and most structural steel contains some post-consumer content; however, a steel mill or steel fabricator should be consulted to confirm that Grade 350 Weldable Steel can be produced from a large fraction of post-consumer material.

**Level 2:**

The structural steel content must include 80% post-consumer recycled steel. Approximately 93% of structural steel is recycled. If Grade 350 Weldable Structural Steel can be produced from 80% post-consumer recycled steel, then this is acceptable. Either a steel mill or a steel fabricator should be consulted to ensure this is a viable option.

**Level 3:**

Refer to International Living Future Institute's Living Building Challenge. Most structural steel is oftentimes produced from 100% recycled material. Rebar for concrete could be an exception due to its higher grade.

*Steel Rebar*

**Level 1:**

The steel rebar content must include 50% post-consumer recycled steel. As discussed above, 93% of structural steel is recycled and most structural steel contains a very high percentage of post-consumer content; however, a steel mill or steel fabricator should be consulted to confirm that Grade 400 Steel can

be produced from predominately post-consumer (or recycled) steel. Because this is a higher grade, it might be more challenging.

**Level 2:**

The structural steel content must include 75% post-consumer recycled steel. Approximately 93% of structural steel is recycled. If Grade 400 Steel rebar can be produced from 75% post-consumer recycled steel, then this is acceptable. Either a steel mill or a steel fabricator should be consulted to ensure this is a viable option.

**Level 3:**

Refer to International Living Future Institute's Living Building Challenge.

*Sheet Steel Used for Decking*

**Level 1:**

The structural steel content must include 50% post-consumer recycled steel. Approximately 93% of structural steel is recycled and most structural steel contains some post-consumer content; however, a steel mill or steel fabricator should be consulted to confirm that Grade 350 Weldable Steel can be produced from a large fraction of post-consumer material.

**Level 2:**

The structural steel content must include 80% post-consumer recycled steel. Approximately 93% of structural steel is recycled. If Grade 350 Weldable Structural Steel can be produced from 80% post-consumer recycled steel, then this is acceptable. Either a steel mill or a steel fabricator should be consulted to ensure this is a viable option.

**Level 3:**

Refer to International Living Future Institute's Living Building Challenge.

## 2.2. Embodied Carbon Footprint

The intent of this measure is to reduce the embodied carbon footprint of projects, while promoting environmental and social sustainability.

All construction products have some environmental impact. This impact is present at all stages of a product's life from cradle to grave and each material outperforms the other at different stages of the process. The best tool we have at hand is conducting a Life Cycle Assessment of each product.

Therefore, we recommend that in the selection of a structural system, materials, and finishes that a Life-Cycle Assessment (LCA) be conducted and a carbon footprint report be prepared to identify the Global Warming Potential (GWP), measured in kilograms of Carbon Dioxide equivalent (CO<sub>2</sub>e). The Building Life-Cycle Impact Reduction in greenhouse gases must be estimated, which should account for demolition and decommissioning, and the diversion rates of each construction material should be taken into account.

## 2.3. Ozone Depleting Compounds

The intent of this measure is to reduce stratospheric ozone depletion and limit human health impacts caused by refrigerant emissions.

Mechanical air conditioning units are release harmful HCFC' from the refrigeration liquid. HVAC coolants naturally deplete over time by leaks in piping and fittings.

**Level 1** – Calculate and report HVAC & Equipment emission associated with the air handling units installed. All equipment using refrigerants in its process to provide air conditioning must comply with equation  $LCGWP + LCODP * 105$  must be less or equal to the number 13.

**Level 2** – Calculate and report carbon footprint as calculated in step 1 and to reduce to completely eliminate the HCFC and Halon emissions.

**Level 3** – Not feasible for this project, as this option requires zero level of refrigerant and the use of evaporative cooling. Evaporative cooling is not likely option for areas with high humidity in the summer such as the greater Toronto area.

## 3. Transportation Performance Requirements

### 3.1. Electric Vehicle Infrastructure



The intent of this measure is to reduce community-wide GHG emissions by promoting electric vehicle use.

**Level 1** - Design the building to provide 20% of parking spaces with electric vehicle supply equipment (EVSE) of Level 2 or higher. The remaining parking spaces must be designed to permit future EVSE installation (i.e. EV-ready). Include at least two regular electrical outlets for electric bicycle charging in bike storage area(s).

Vehicle charging requirements place a large demand on the electrical power distribution system. As a result, the

power distribution service capacity and all associated equipment including the generator must also be increased.

**Level 2** Charging Stations are available anywhere from 3KW to 20KW. The higher the wattage, the faster they charge. As these cars for these stations are anticipated to be charging for over 8 hours, we can specify a lower wattage to reduce the impact on the electrical system. For 3 x 5KW, the increase in service size can be ignored as this is within the safety factor but if the design is expected to provide provisions for future connection for all parking spots, then the service size will have to accommodate for 15+ parking spaces which will require a possible 50% increase in service size and all associated power distribution.

In order to prevent a large increase in service size, it is recommended that future charge ready parking spots be placed on a control system which limits and cycles power from one spot to another when cars are plugged in. The system can be programmed to within the limits of the power system in order not to oversize the incoming power system on day 1 to accommodate future loading. The should be understood that future vehicle charging stations can be added but at that time not all stations will receive 100% charging capacity at all times. This is how most charging parking lots are presently designed.

Costing for each vehicle charging station complete with all associated infrastructure is anticipated to be \$10,000 per station for complete stations and \$2,000 for each future parking spot to make them EV-ready.

**Level 2** - Design the building to provide 25% of parking spaces with electric vehicle supply equipment (EVSE) of Level 2 or higher. The remaining parking spaces must be designed to permit future EVSE installation (i.e. EV-ready). Include at least two regular electrical outlets for electric bicycle charging in bike storage area(s).

Similar to Level 1, costing for each vehicle charging station complete with all associated infrastructure is anticipated to be \$10,000 per station for complete

stations and \$2,000 for each future parking spot to make them EV-ready.

**Level 3** - Design the building to provide 30% of parking spaces with electric vehicle supply equipment (EVSE) of Level 2 or higher. The remaining parking spaces must be designed to permit future EVSE installation (i.e. EV-ready). Include at least two regular electrical outlets for electric bicycle charging in bike storage area(s).

Similar to Level 1, costing for each vehicle charging station complete with all associated infrastructure is anticipated to be \$10,000 per station for complete stations and \$2,000 for each future parking spot to make them EV-ready.

### 3.2. Bicycle Infrastructure

Providing bicycle infrastructure reduces community reliance on vehicles, lessen traffic congestion, and improve public health by promoting bicycles as a reliable mode of transportation.

**Level 1:** A minimum of 8 bicycle parking spaces is required for the building.

**Level 2:** A minimum of 8 bicycle parking spaces is required for the building.

**Level 3:** A minimum of 12 bicycle parking spaces is required for the building.

Include a bike repair station in the shop area of the station.



## 4. Waste Management Performance Requirements

The intent of this requirement is to reduce the amount of construction and demolition waste that is sent to landfills or incinerated by promoting good waste management practices.

To meet all levels a Construction and demolition waste management plan should be provided and a Construction and demolition waste declaration to be provided post construction. Refer to the CGB Standards for detailed requirements for each level.

## 5. Water Performance Requirements

### 5.1. Stormwater Management

The intent of this measure is to manage and reduce the stormwater discharge from the site to city sewer system by controlling roof drains flow and by absorbing the water on the site soil.

#### *site design:*

Consider permeable paving over conventional paving to capture precipitation and reduce surface run off. Consciously design in vegetation beds in parking areas over hardscaping to capture more storm water and reduce flow velocities.

#### *mechanical design:*

**Level 1** – Installing control flow roof drains to collect water on the roof of building and installing scupper drain for any overflow that will flow onto grade. Introduce gray water system by collecting rain water in storage tanks above ground for irrigation use. Provisions to achieve these requirements is negligible to the total mechanical budget. The structural load on the roof will have to be reviewed by the structural discipline.

**Level 2** – Design a water storage cistern that is designed to store a once in 100-year rainfall. The tank will be stored

below grade and away from vehicle traffic. The system will require space to install the pumps and irrigation system and other non-potable water use services. The storage system will be designed with the option to bypass and discharge directly into city's street storm lines. This option will add at least 20% to the mechanical and civil budgets.

**Level 3** – In addition to the above, a green roof system designed by architect and structural engineer may require drainage system. Mechanical scope of work is dependent on the type of green roof. Allow a 10% adder to the mechanical plumbing and drainage budget.



#### *civil design:*

By referencing historic rainfall data for the project location, a storm management plan will be designed, utilizing a combination of green infrastructure and low-impact development strategies to replicate the site's natural hydrological cycle and reduce the peak flow and runoff volume

Provide a stormwater management report, include rainfall data & volume calculations. A stormwater management plan must be prepared along with details, and/or cross-sections consistent with report and including topography, landscaping, grading, etc. After the project is completed, a post construction stormwater runoff declaration must be provided.

Refer to the CGB Standards for detailed requirements for each level.

## 5.2. Water Use Intensity

The intent of this measure is to conserve potable water by reducing water used inside the building and for irrigation.

To reduce potable water usage it is important to select highly water efficient fixtures in addition to employing rainwater collection systems. Rainwater can be used for landscape irrigation and other uses that don't require significant treatment. If the collection vessels are on or under the ground, they don't pose a problem. Gray water is typically recognized as a source of potentially recycled water that has been used but not polluted. This normally comes from bathing, washing, and similar activities. Gray water can be collected and reused for landscape irrigation and other uses that don't require potable water.



**Level 1** – Install high efficiency toilets, urinals, faucets, and shower heads. Install aerators on faucets heads to further reduce water discharge. The water closet (toilet) flow rates can start from 1.28 gallons per flush (gpf) and down to 0.8 gpf. The show flow rates to 1.75 gpm @ 80 psi of pressure, and sink faucets down to 1.5 gpm. Installing electronic no touch faucets and timers on showers help to reduce water usage. Cost of installing water saving fixtures is approximately 1-2% of total mechanical budget.

**Level 2** – Use gray water for all irrigation demand. Rainwater from roof drains can be collected into a storm water reservoir. The incoming water into the tank will be

strained and filtered. The water can then be pumped for reuse. The tank can be buried similar to a septic tank at landscaped area near the building. The drawback to using gray water for all outdoor potable services is that supply may not always satisfy the demand. The cost addition is estimated to be between 5-10% of the mechanical budget.

**Level 3** – Using gray water to flush toilets and urinals will help achieve level 3. This measure requires the installation of a separate water supply piping system from the cistern to the fixtures. There is added cost of pump installation and operation to push the water from tank to the fixtures. The additional cost associated with this option is approximately 10-15% of the mechanical cost.

## 6. Natural Heritage Performance Requirements

### 6.1. Erosion and Sediment Control

During construction, an Erosion & Sediment Control plan is to be established to ensure stormwater runoff during this phase does not transport sediment to the existing municipal infrastructure. Refer to the CGB Standards for detailed requirements for each level.

### 6.2. Light Pollution

The intent of this measure is to reduce the negative impacts that a building's lighting can have while accentuating the benefits.

Light pollution is misused light caused by glare, light trespass, over lighting, and sky glow. It generally results from exterior lighting designs that are inappropriate for the site context. While proper lighting is important for human safety and convenience, light pollution creates numerous environmental problems. It can interrupt wildlife species that hunt or forage at night and disrupt the movement patterns of others (e.g. migratory birds

and bats). Misdirected light can also impact human health, with implications for our night vision, circadian rhythms, melatonin production, and sleep patterns. In addition, light pollution into areas that do not need illuminating is a waste of both energy and money.

When designing the station ensure that site lighting is not shining directly into indoor spaces especially since stations are occupied 24/7 and this could be a source of nuisance.

**Level 1** - All exterior fixtures must be Dark Sky compliant, as per the International Dark Sky Association (IDA). Any rooftop and facade architectural illumination must be directed downward and turned off after facility operating hours. Install an automatic device that reduces the outward spillage of internal light by:

- Reducing the input power to non-emergency lighting fixtures by at least 50 per cent outside of facility operating hours.
- Shielding all non-emergency light fixtures outside of facility operating hours.

A lighting list highlighting Dark Sky compliant fixtures shall be provided as part of the lighting schedule. A lighting plan showing boundaries, location of fixtures, and lighting control measures will be provided as part of the photometric analysis during detailed design. A lighting controls declaration to be provided post construction by the contractor and signed off by the engineer of record.

The costs associated with installation of dark sky compliant fixtures is no more than what is already required by ASHRAE SB-10 requirements and most municipalities.



**Level 2** – This level incorporates all requirements outlined in Level 1 as well as the requirement to ensure that any lighting not physically attached to the building is connected to solar PV as a primary source of power. This requirement includes all light

poles having an onboard solar charging component. The cost addition for this provision shall be budgeted at \$1,000 to \$1,500 per pole.

### 6.3. Biodiversity

To conserve biodiversity by promoting planting while avoiding invasive species, in addition to protecting local bird species.

**Level 1** - The landscaping plan must indicate soil volume, species and quantity for each planting area. It is also to include a comprehensive plant list, provided including both common and scientific names of each plant, and highlighting all pollinator-friendly and native species.

- Provide trees planted in both softscape & hardscape, and ensure these trees have at least the minimum required soil volume. 15 cubic meters of high-quality soil will be provided for small trees, 30 m3 for medium trees and 45 m3 for large-sized trees.



- The site landscaping must include the planting of 'shade trees' Approximately 6 - 8 m apart along all street frontages, open space frontages and public walkways.
- The landscaped area should include pollinator-friendly species. At least 10% of all plantings provided must be pollinator-friendly.



- The use of indigenous plant species is to be prioritized. Ensure that at least 25% of all proposed plantings are native species to the region.
- No invasive plant species are to be used in the landscape design as per Ontario Invasive Plant Council Guidelines.

**Level 2** - This level includes all requirements of level 1 in addition to the following:

- At least 25% of all plantings provided on site must be pollinator-friendly.
- Ensure that at least 50% of all plantings proposed on the landscaping plan are native species to the region.

**Level 3** - This level includes all requirements of level 1 in addition to the following:

- At least 50% of all plantings provided on site must be pollinator-friendly.
- Ensure that 100% of the plantings proposed on the landscaping plan are native species to the region.

In addition to planting requirements, bird friendly development must be demonstrated. Refer to the CGB Standards for detailed requirements for each level.





## 3.0 site design

### Site Plan Design Principles:

- Fire trucks should have enough maneuvering space to be able to access the apparatus bays from the rear and exit from the front directly onto the road.
- The truck egress driveway to be solely dedicated for the fire truck and to be designed as close as possible to the road edge
- Allow enough depth at the front of the apparatus bay for fire trucks to be parked entirely within the property for truck cleaning.
- Zoning and setbacks should conform to the City of Mississauga Zoning By-law
- Minimum 3 metre setbacks on all sides are recommend
- Increased landscaped buffer from residential zones with sound attenuating vegetation is recommended
- Stacking distance from edge of property line to first parking space should be 6 metres minimum
- Provide a flag pole in a prominent location
- Provide access from the public sidewalk to the main entrance
- Barrier-free parking stalls to be designed to slope up to meet the edge of curb for barrier-free access
- Sidewalks providing a barrier-free path of travel should conform to the City of Mississauga FADS with a minimum width of 1500mm.

For each concept, a site plan was explored using the principles detailed above. The aim of this exercise is to determine the minimum site dimensions required to accommodate each proposed concept. This can be used as a guide for the City of Mississauga when considering future properties for the development of new fire stations.

There was no significant change in the minimum required site acreage between a single storey and two storey stations. These studies assume rectangular sites, however in reality sites will be irregular in shape and the important dimensions to be considered would be the minimum clear site widths and depths shown here.

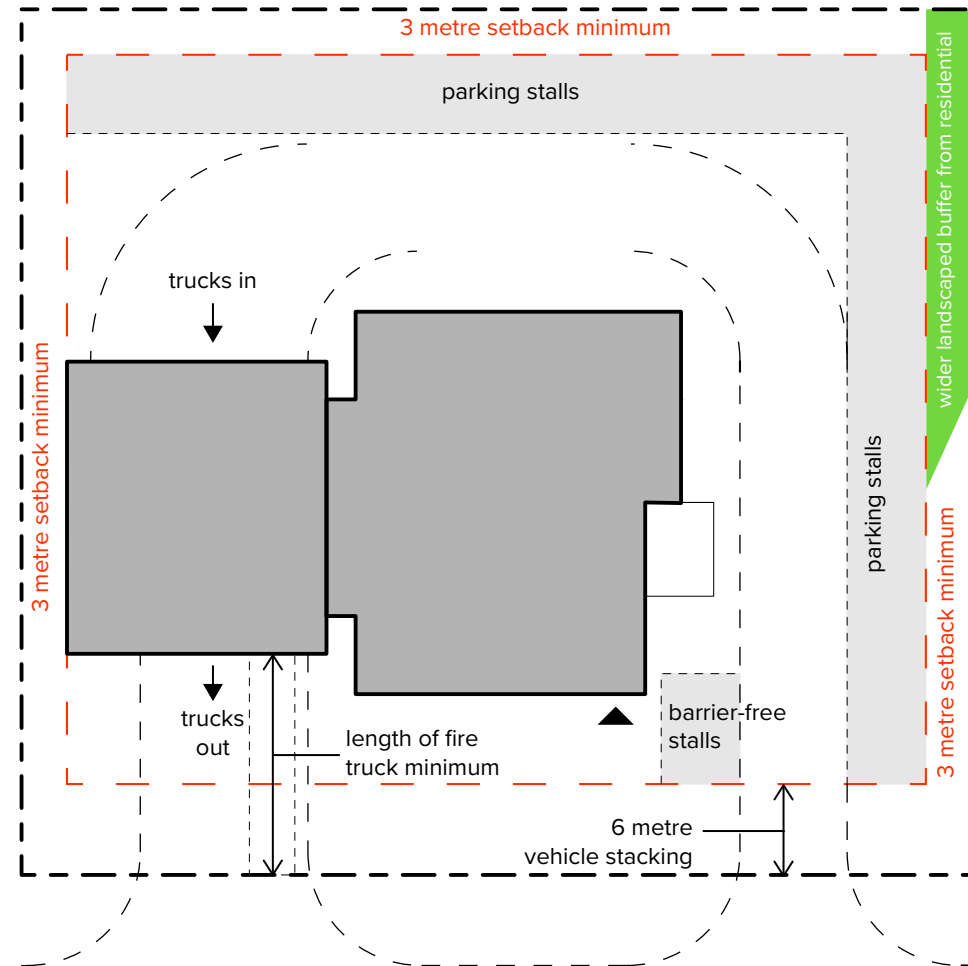

### 3.1 two truck one storey site plan

SITE PLAN - OPTION A

Scale: 1:400

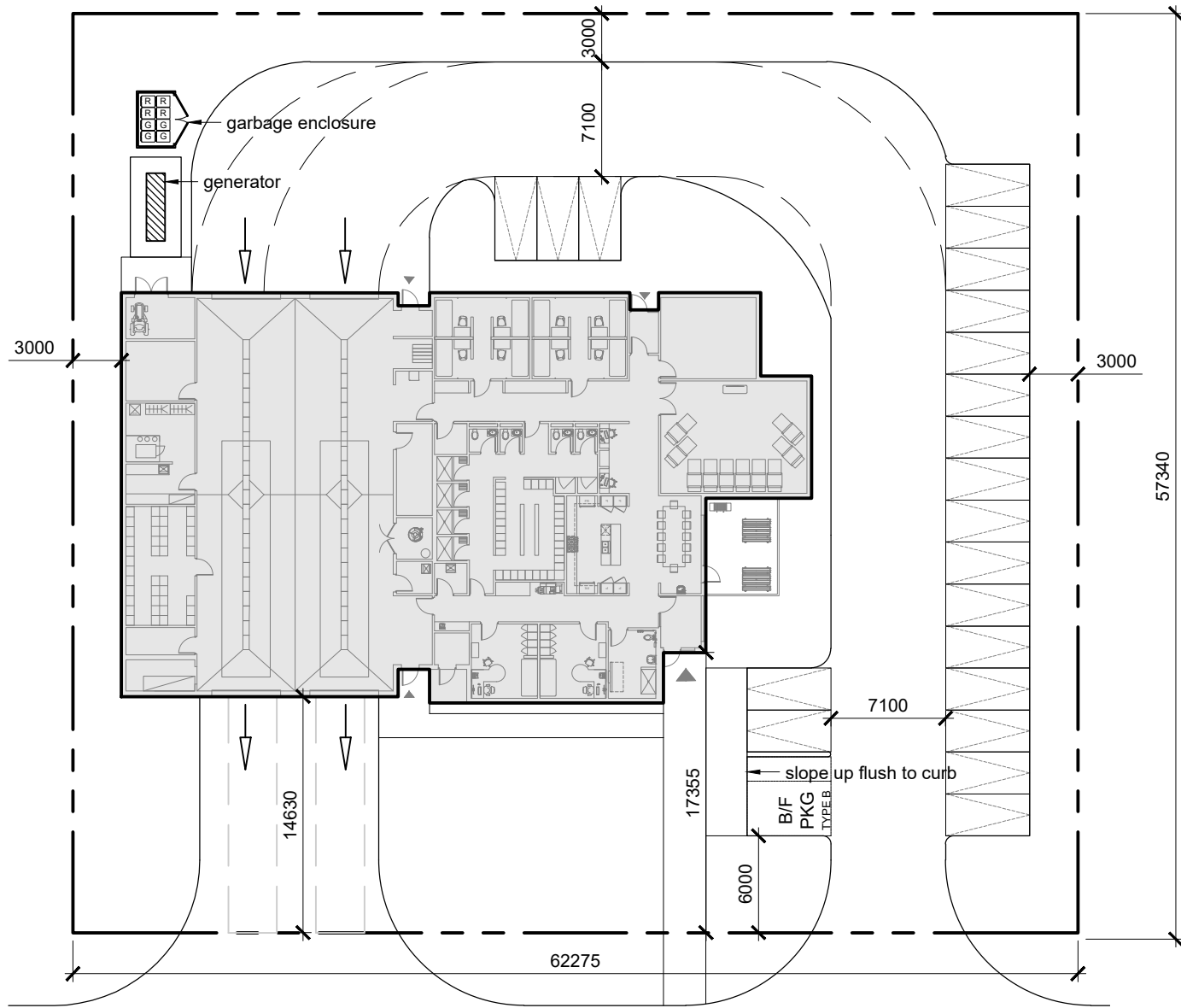

63 m site frontage  
57 m site depth  
0.9 Acres

### 3.2 two truck two storey site plan

SITE PLAN - OPTION A

Scale: 1:400

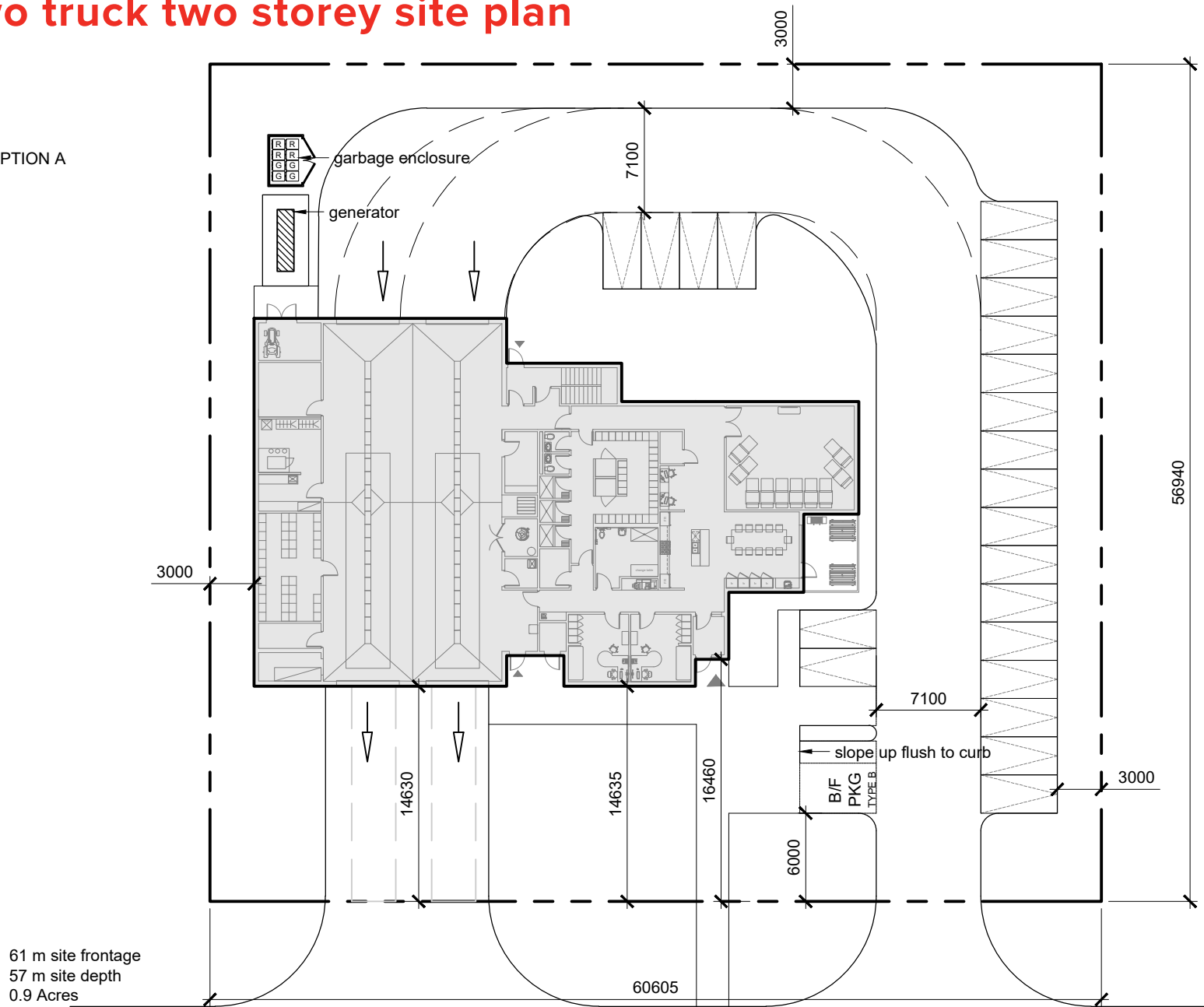

# 3.3 three truck one storey site plan

SITE PLAN - OPTION A

Scale: 1:400

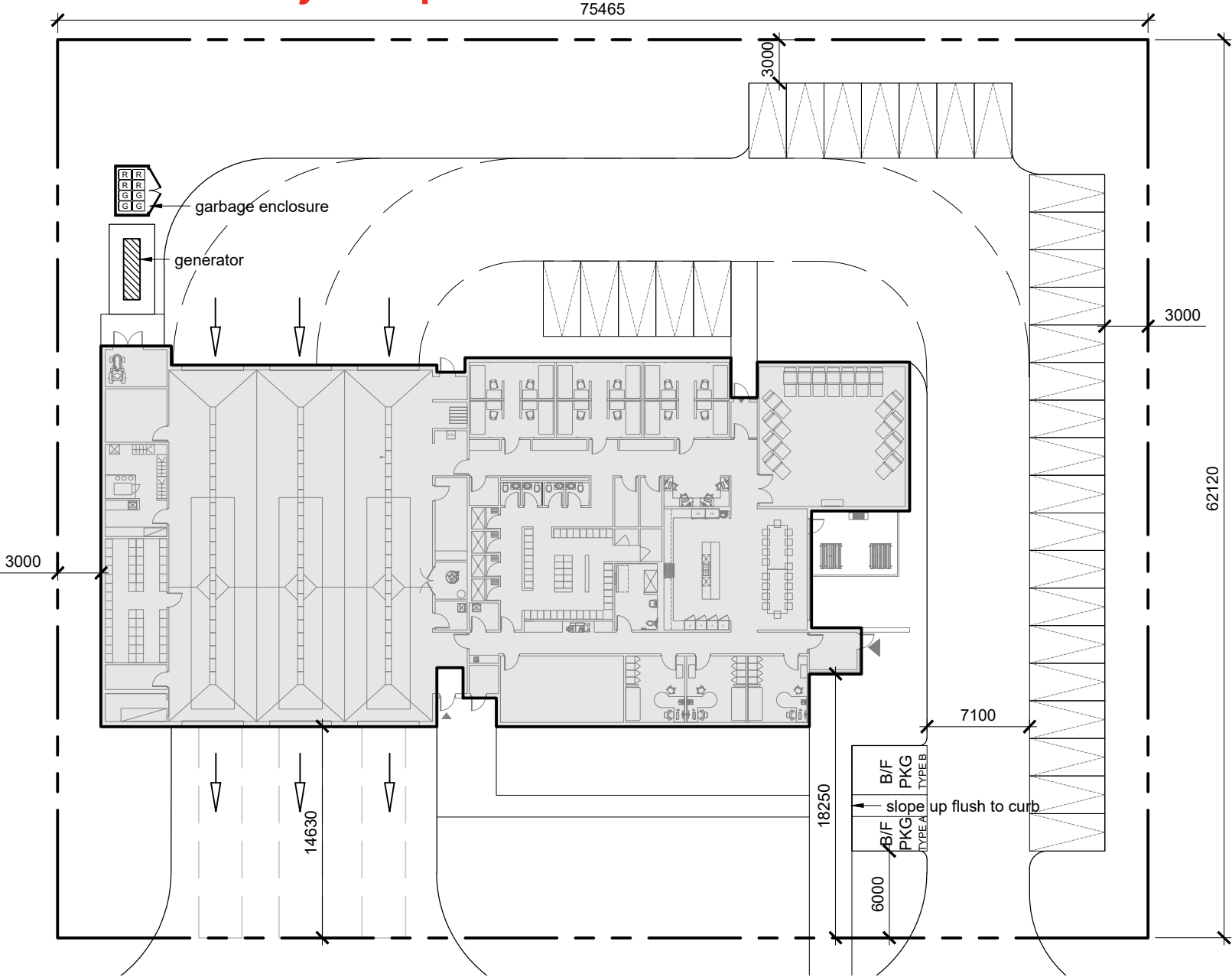

76 m site frontage  
62 m site depth  
1.2 Acres

### 3.4 three truck two storey site plan

SITE PLAN - OPTION A

Scale: 1:400

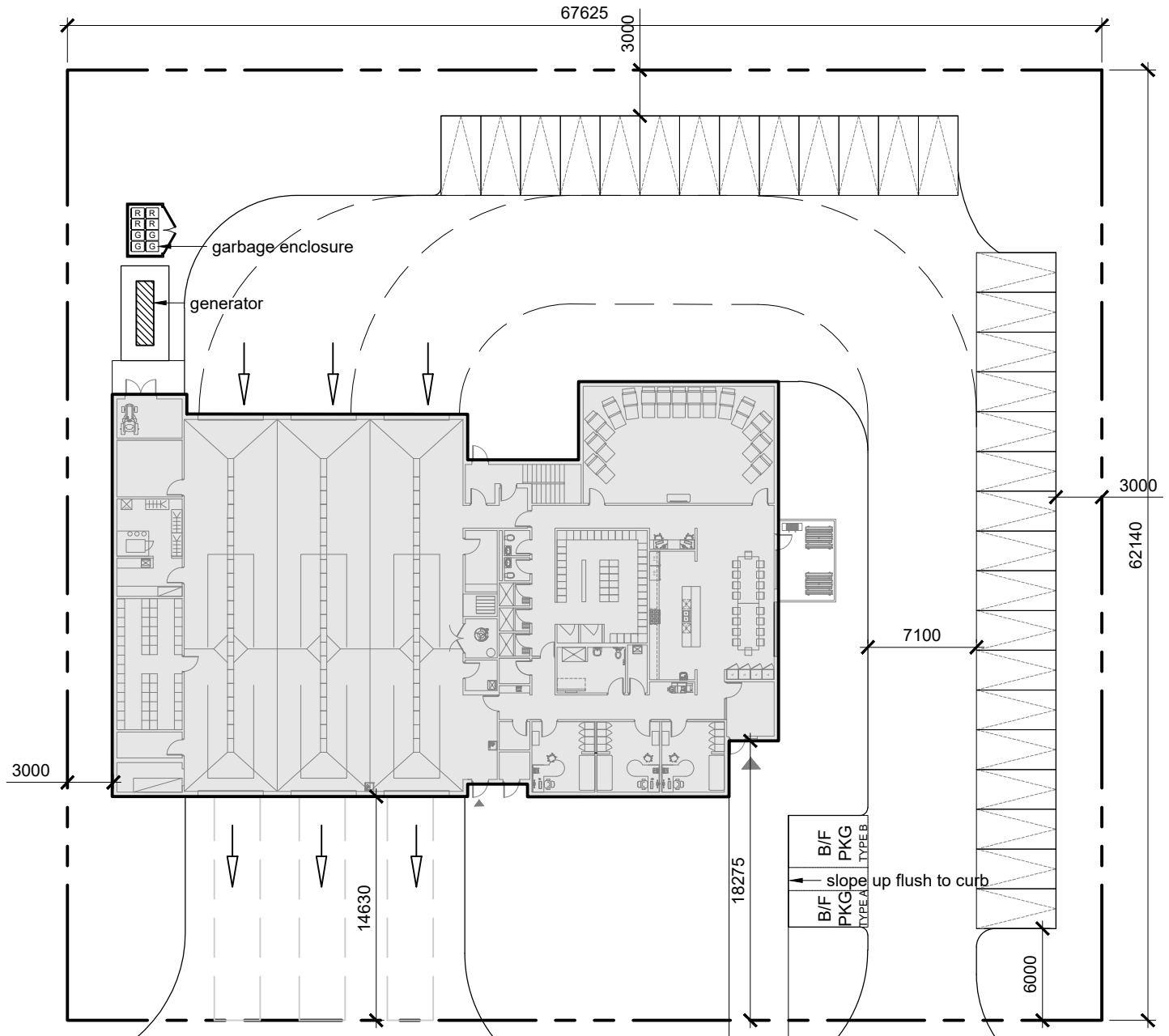

68 m site frontage  
63 m site depth  
1 Acres

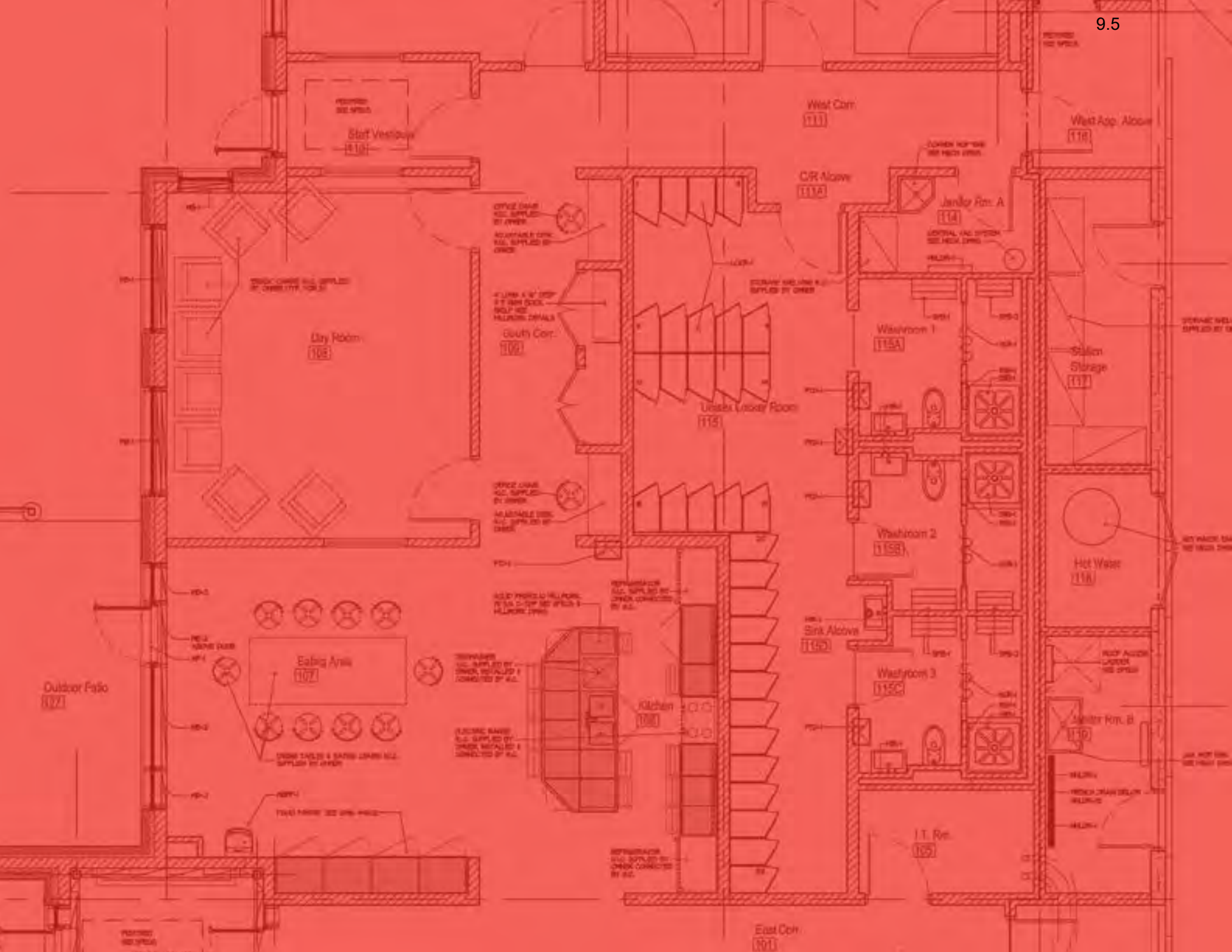

## 4.0 floor plans

### floor plan design principles:

The concepts explored the most compact space possible to satisfy the programmatic requirements.

The circulation between the apparatus bays and living areas is designed as a continuous u-shape that is clear of obstructions. Dorm rooms and captain rooms are situated closest to the apparatus bays. In two storey schemes, the exit stair opens up directly onto the apparatus bays to allow for faster response times.

The kitchen and dining area are designed as a single open plan space with direct access to the outdoor area, and provisions for ample natural light.

All floorplans show a separation of showers and washroom facilities. This was designed as a contamination control measure. There are two access points into the shower/ washroom/ locker area:

- The contaminated access point is directly adjacent to the showers, closer to the access from the apparatus bays. This configuration controls the spread of contamination into the clean areas after responding from a call. Firefighters usually take a shower after returning from a call to decontaminate.
- The clean access point is adjacent to the washrooms so that fire fighters may use those facilities when using the facilities on the clean side.

All plans incorporated a hose rack nook as it was indicated as the preferred option for hose drying and storage.



## 4.1 two truck one storey

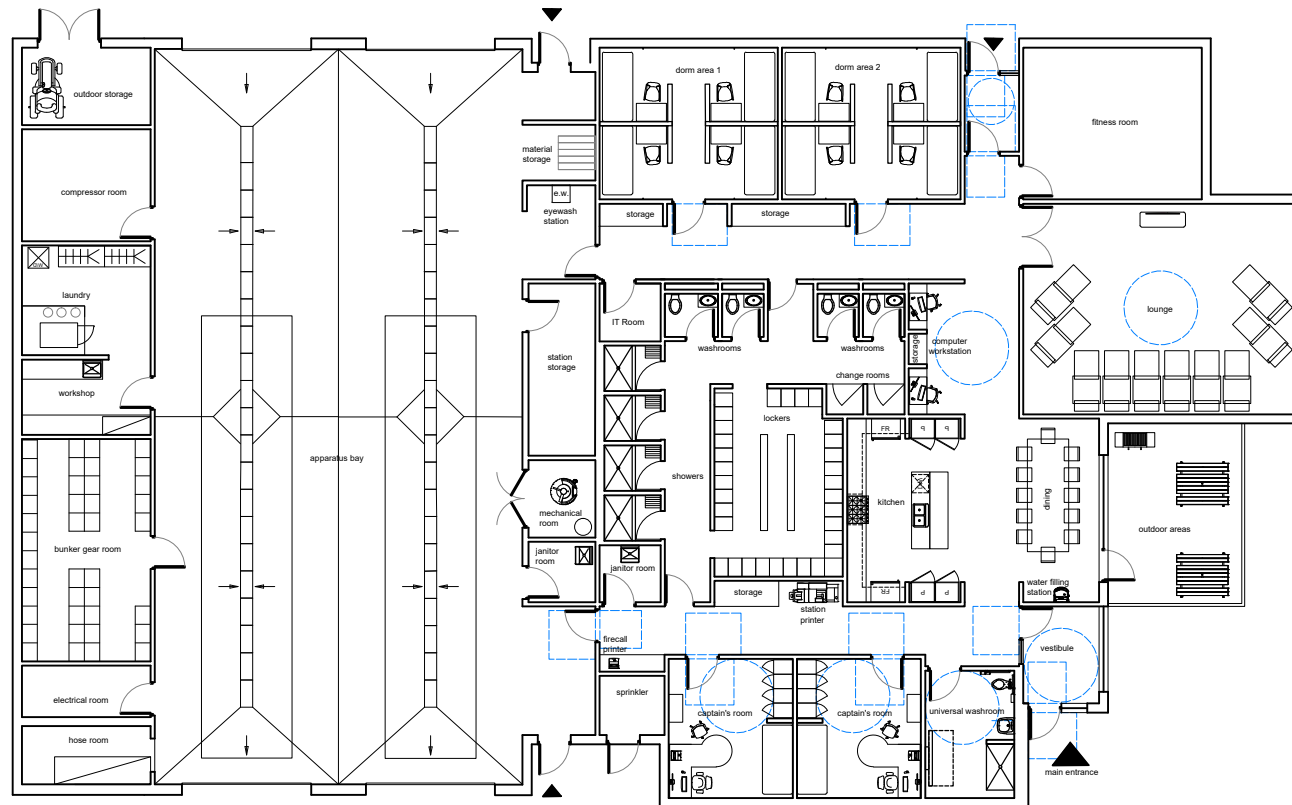

two truck one storey - floor plan

floor area: 960 m<sup>2</sup>

scale 1:250

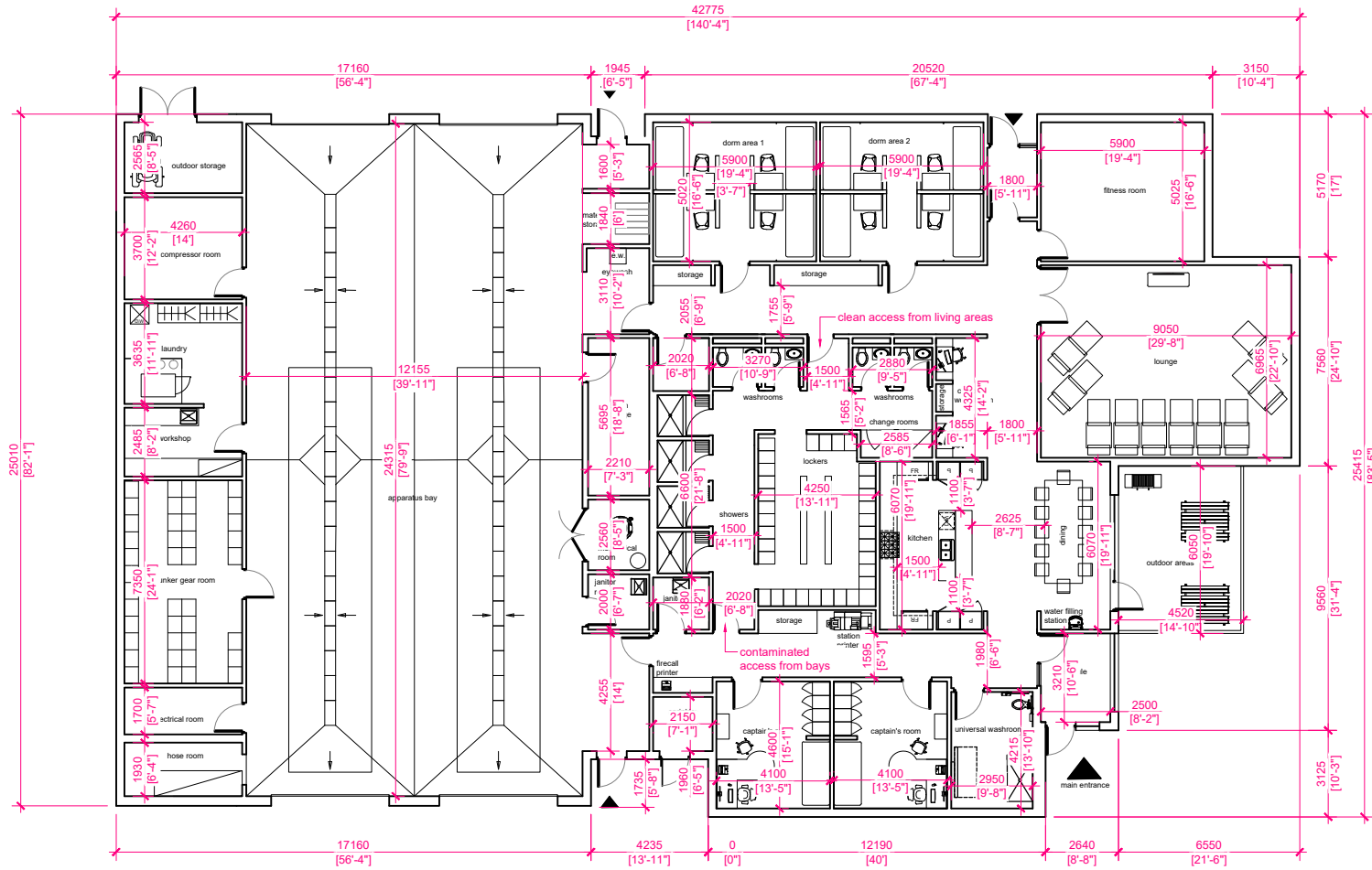

two truck one storey - floor plan - dimensioned  
scale 1:250

## 4.2 two truck two storey

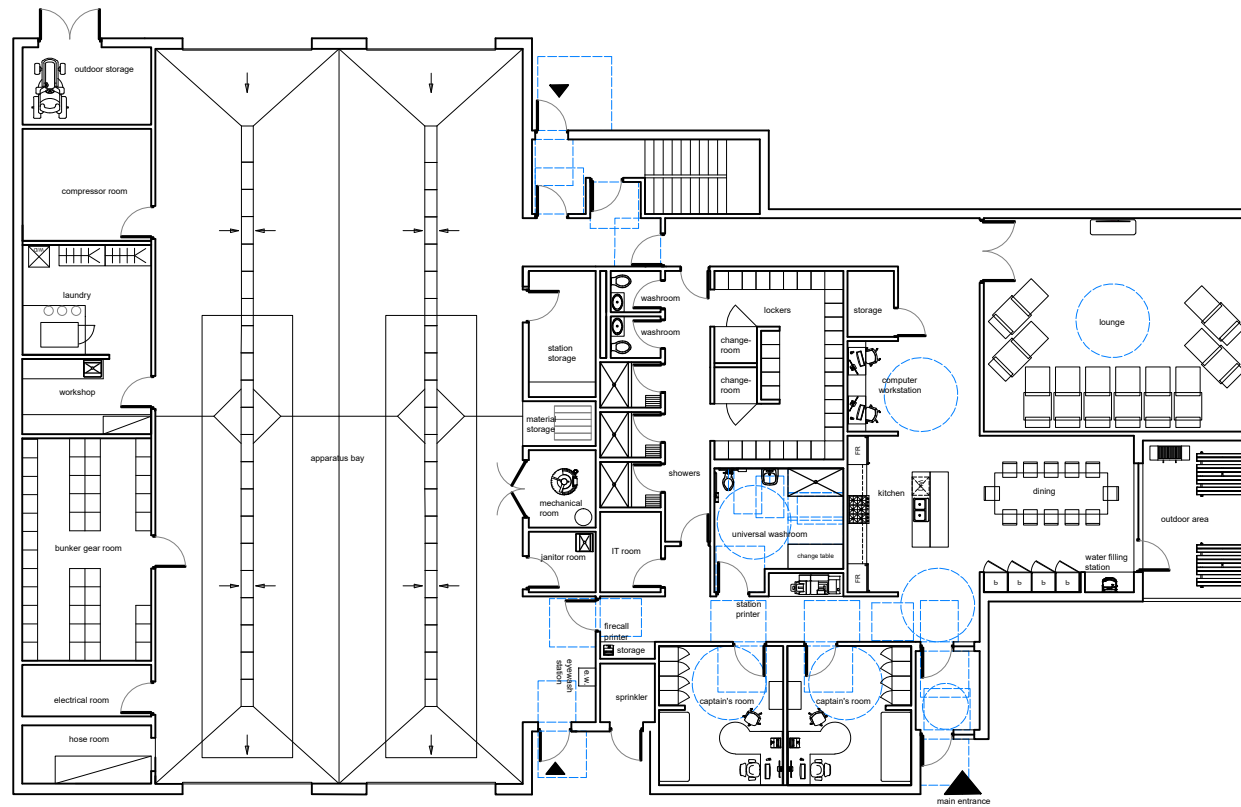

ground floor area: 825 m2

two truck two storey - first floor plan  
scale 1:250

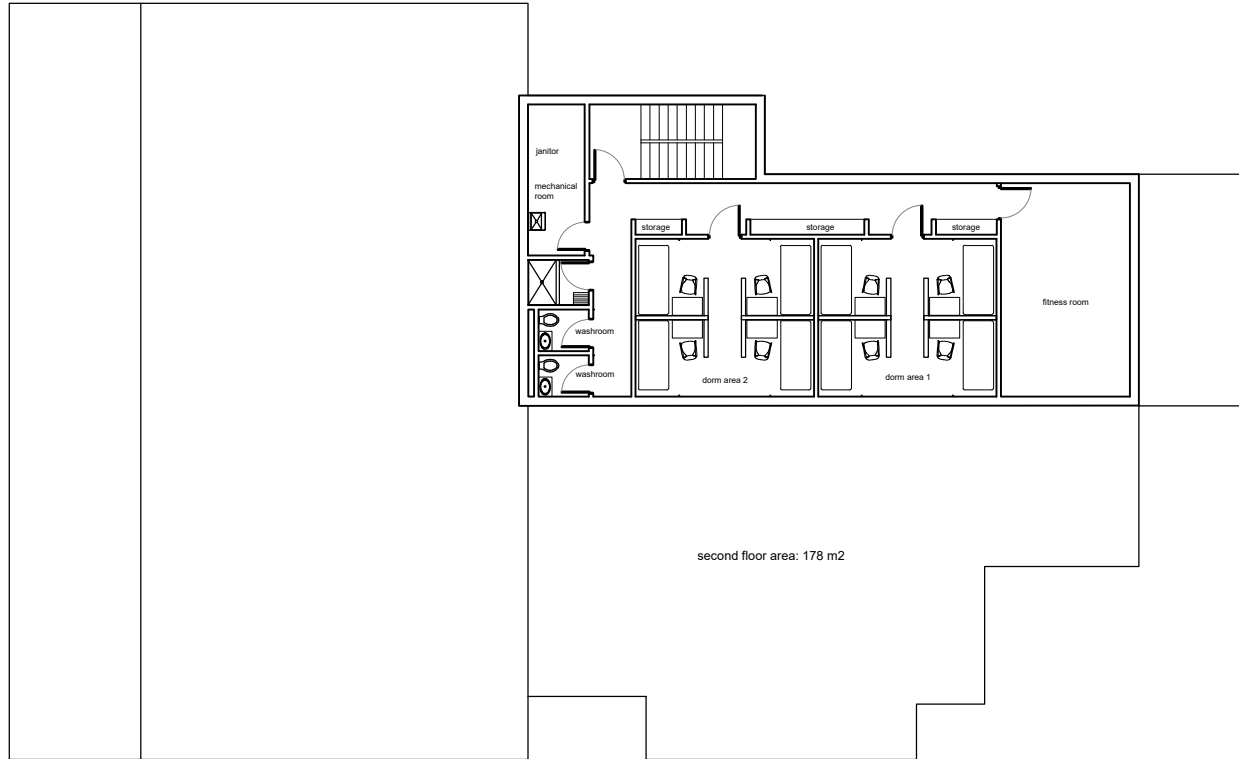

two truck two storey - second floor plan  
scale 1:250

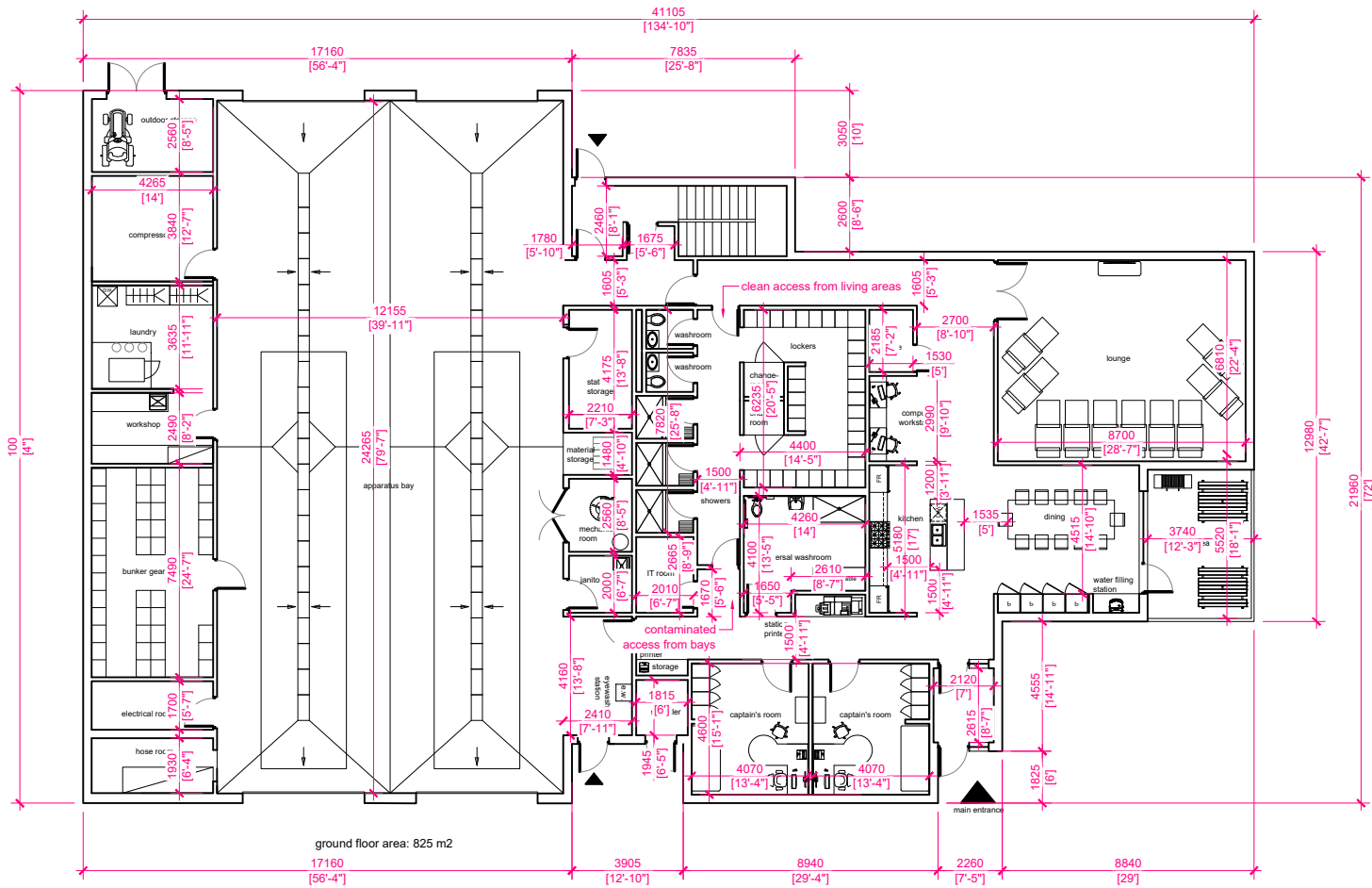

two truck two storey - first floor plan - dimensioned  
scale 1:250

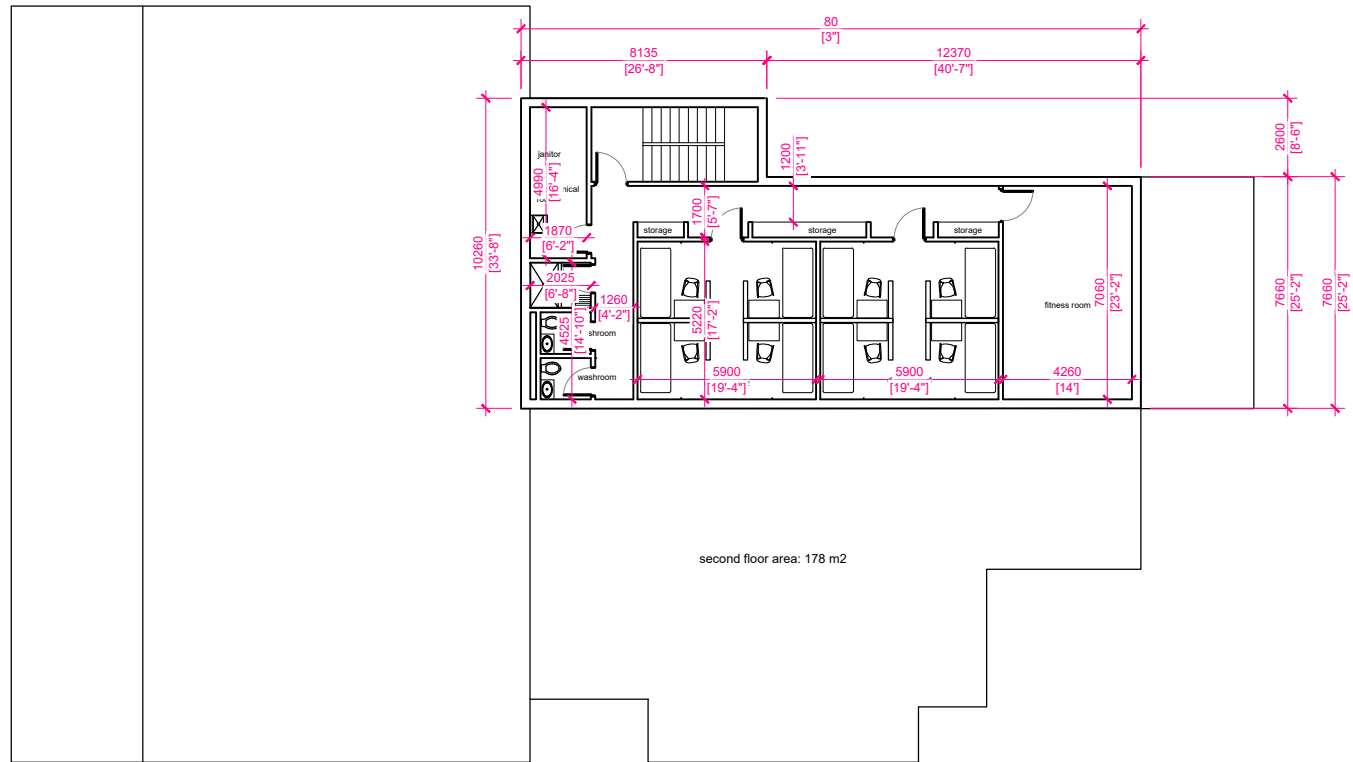

two truck two storey - second floor plan - dimensioned  
scale 1:250

## 4.3 three truck one storey

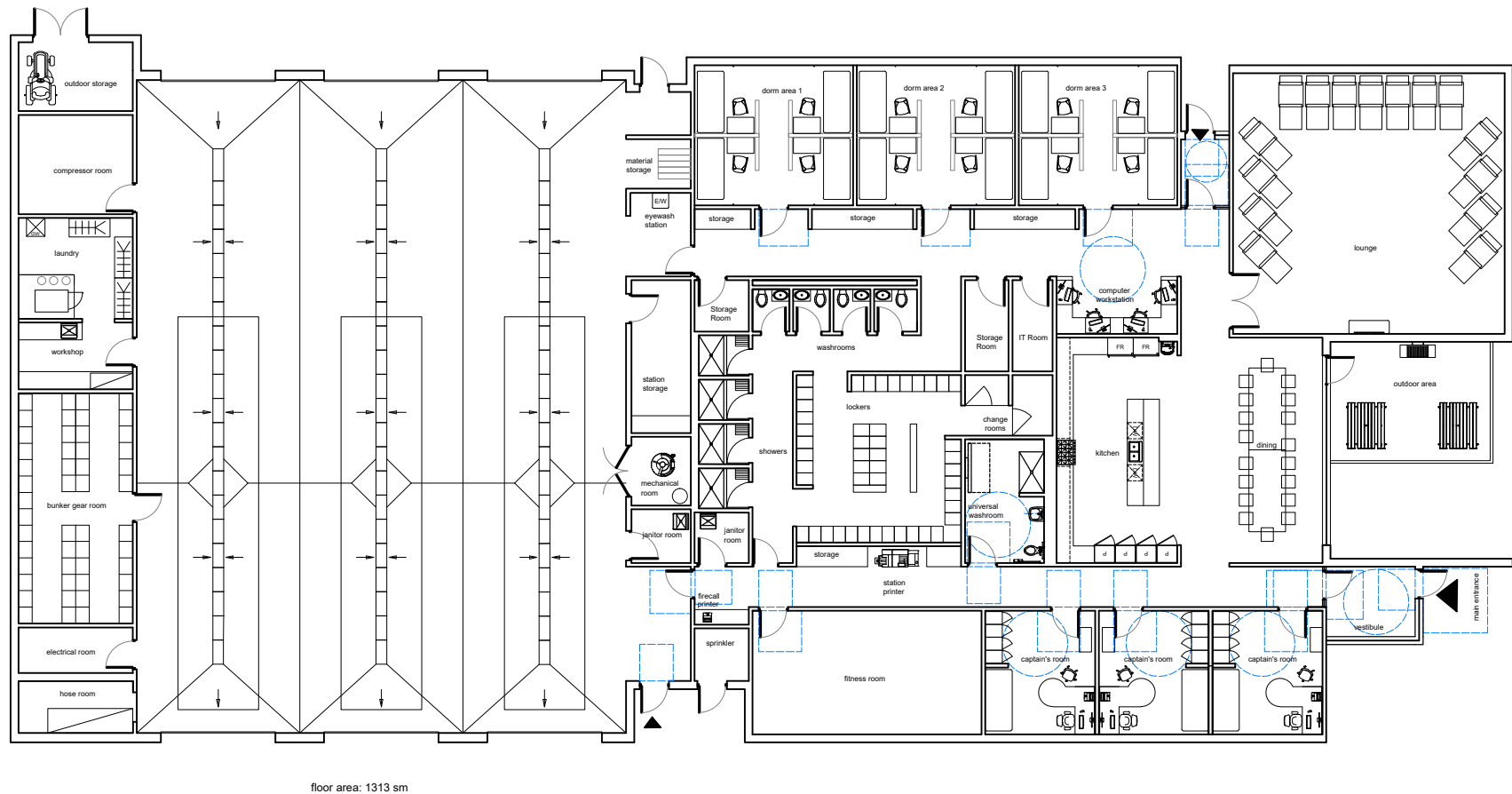

three truck one storey - floor plan

scale 1:250

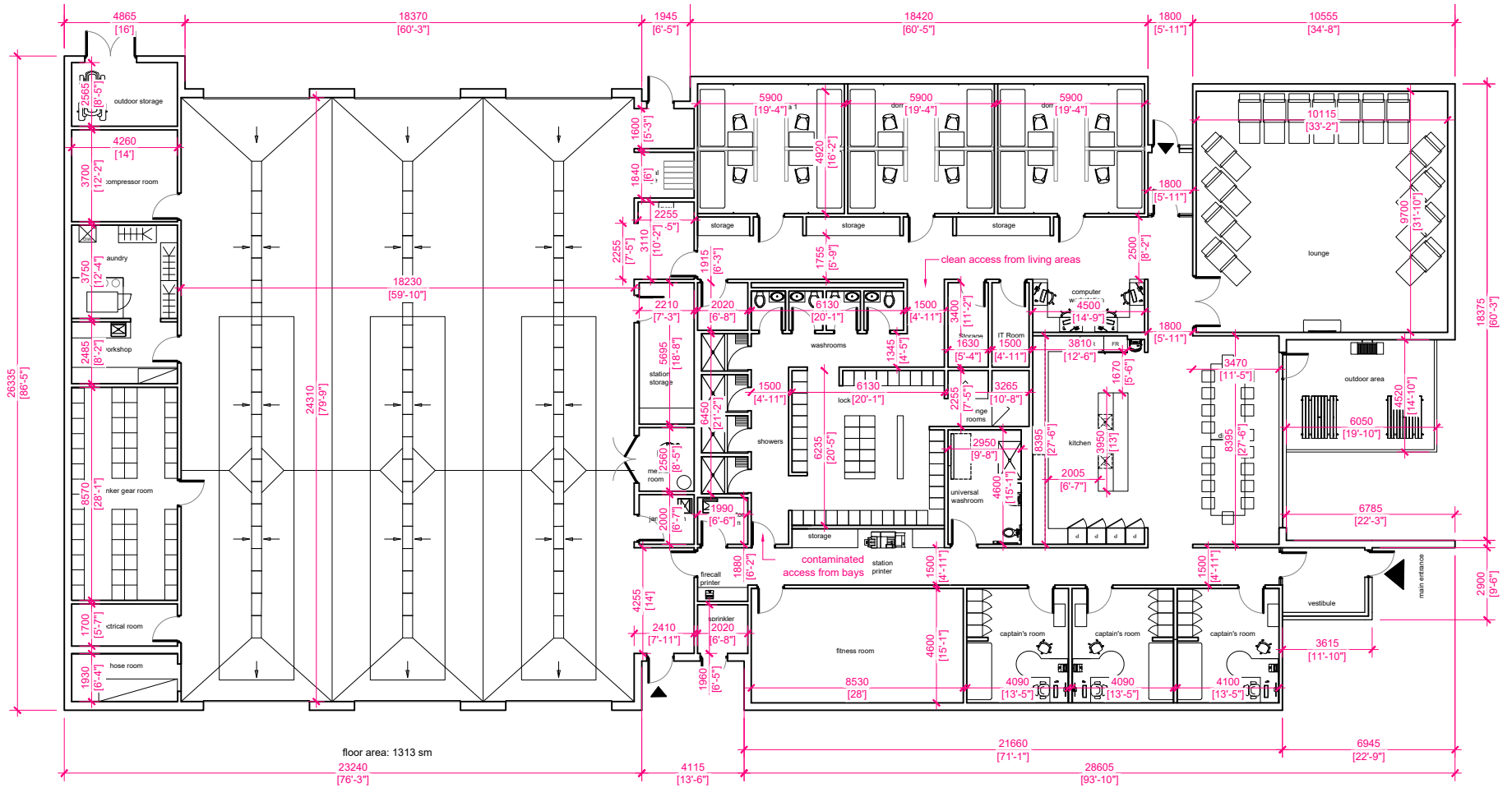

three truck one storey - floor plan - dimensioned  
 scale 1:250



## 4.4 three truck two storey

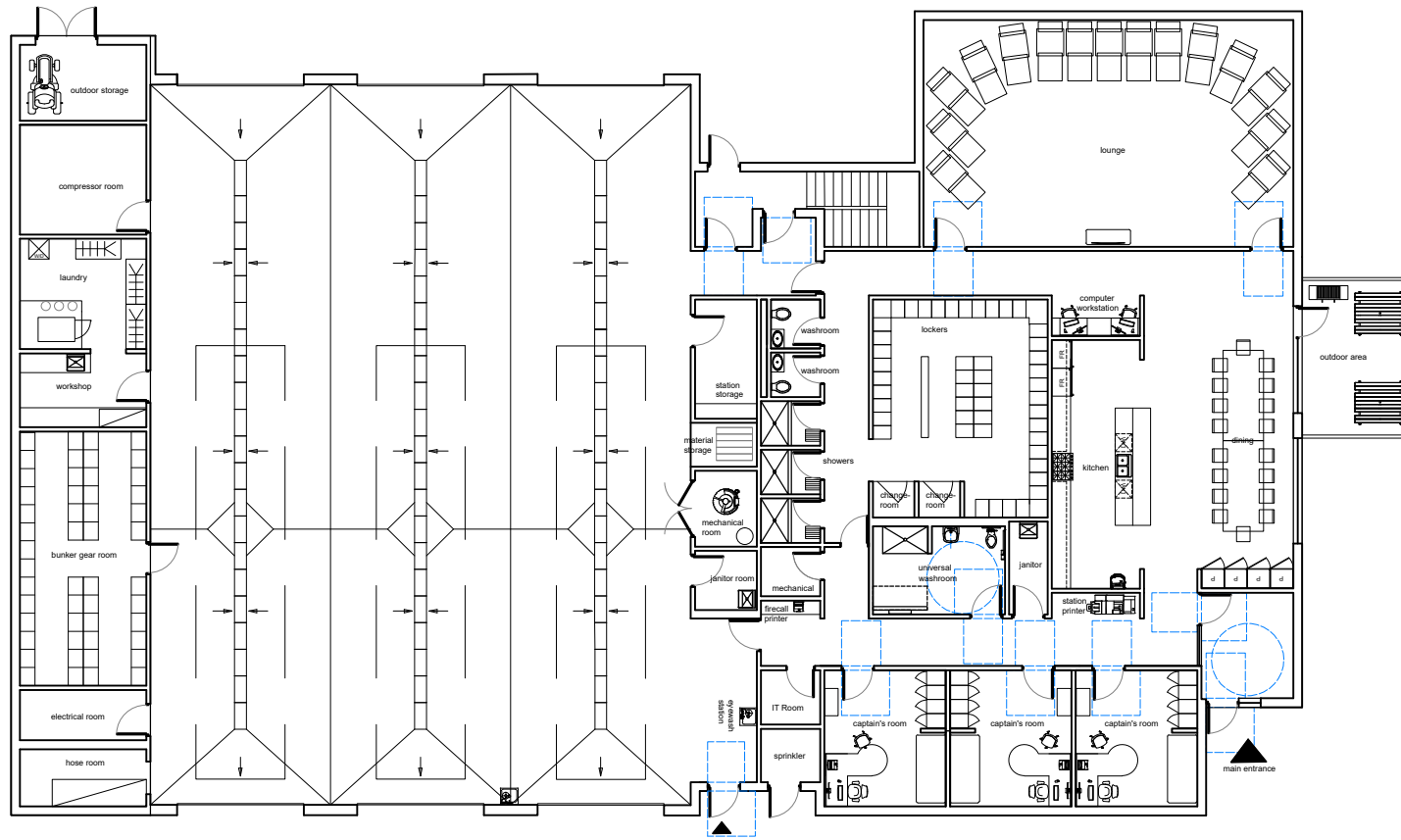

ground floor area: 1087 m2

three truck two storey - floor plan - Level 1

scale 1:250

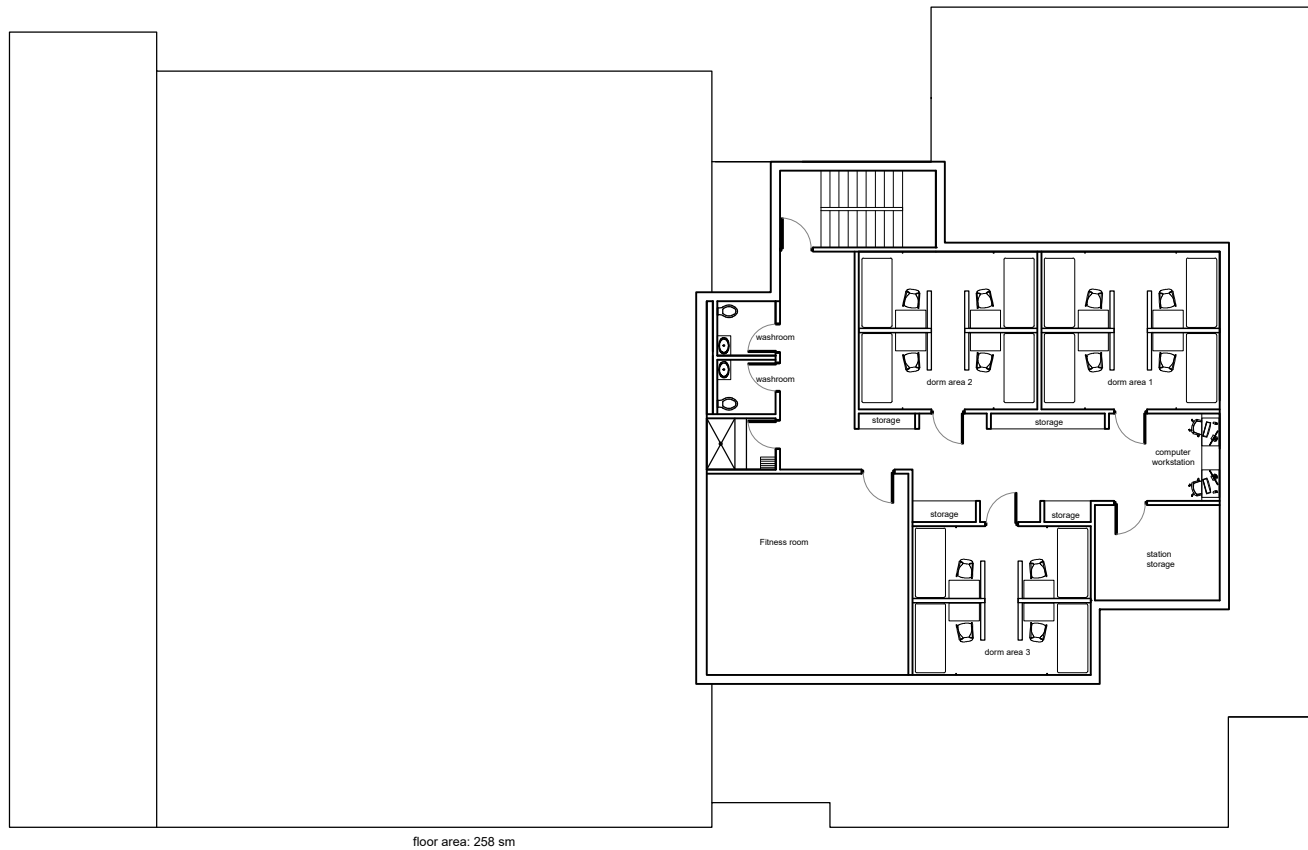

three truck two storey - floor plan - Level 2  
scale 1:250

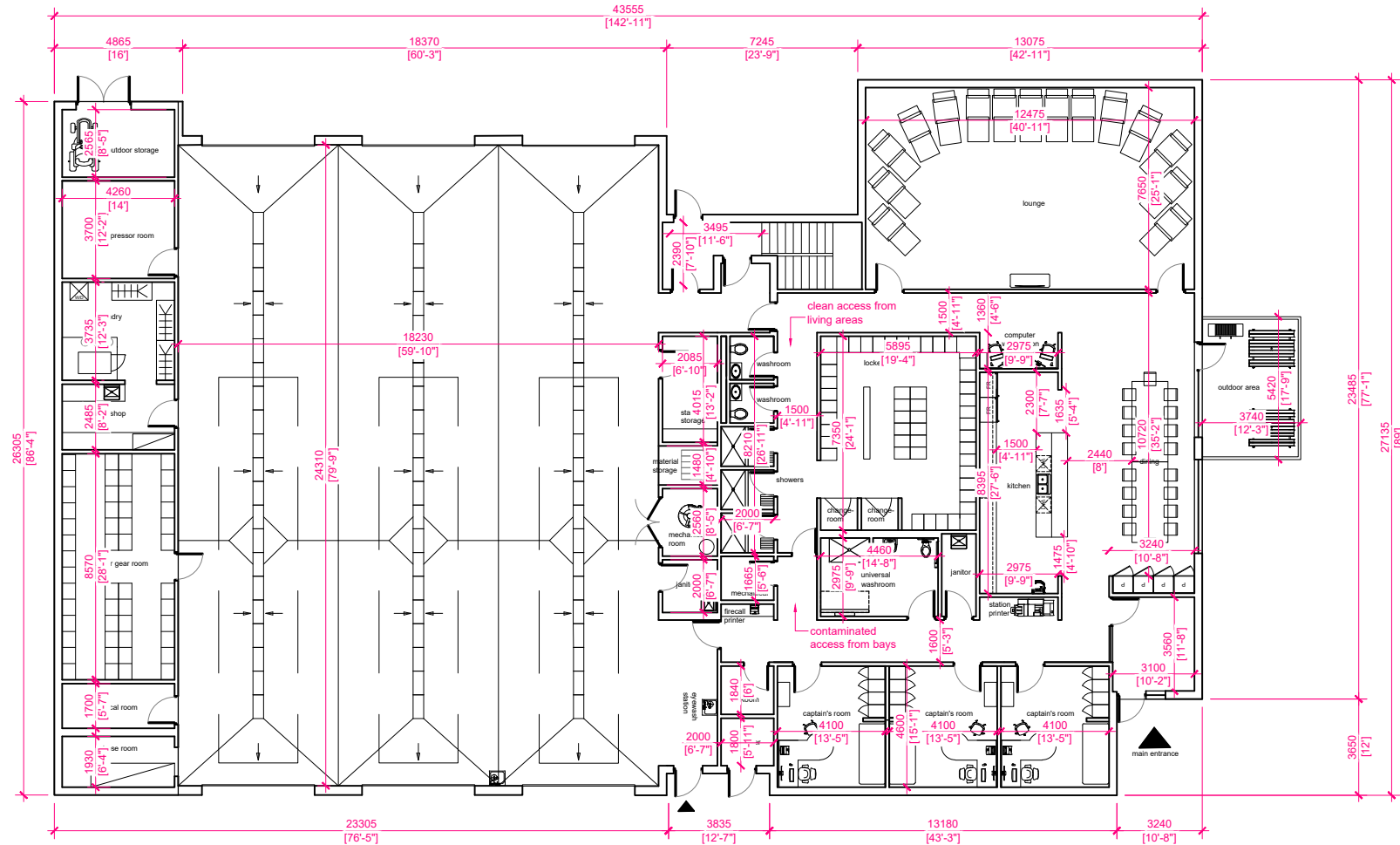

three truck two storey - floor plan - dimensioned  
 scale 1:250

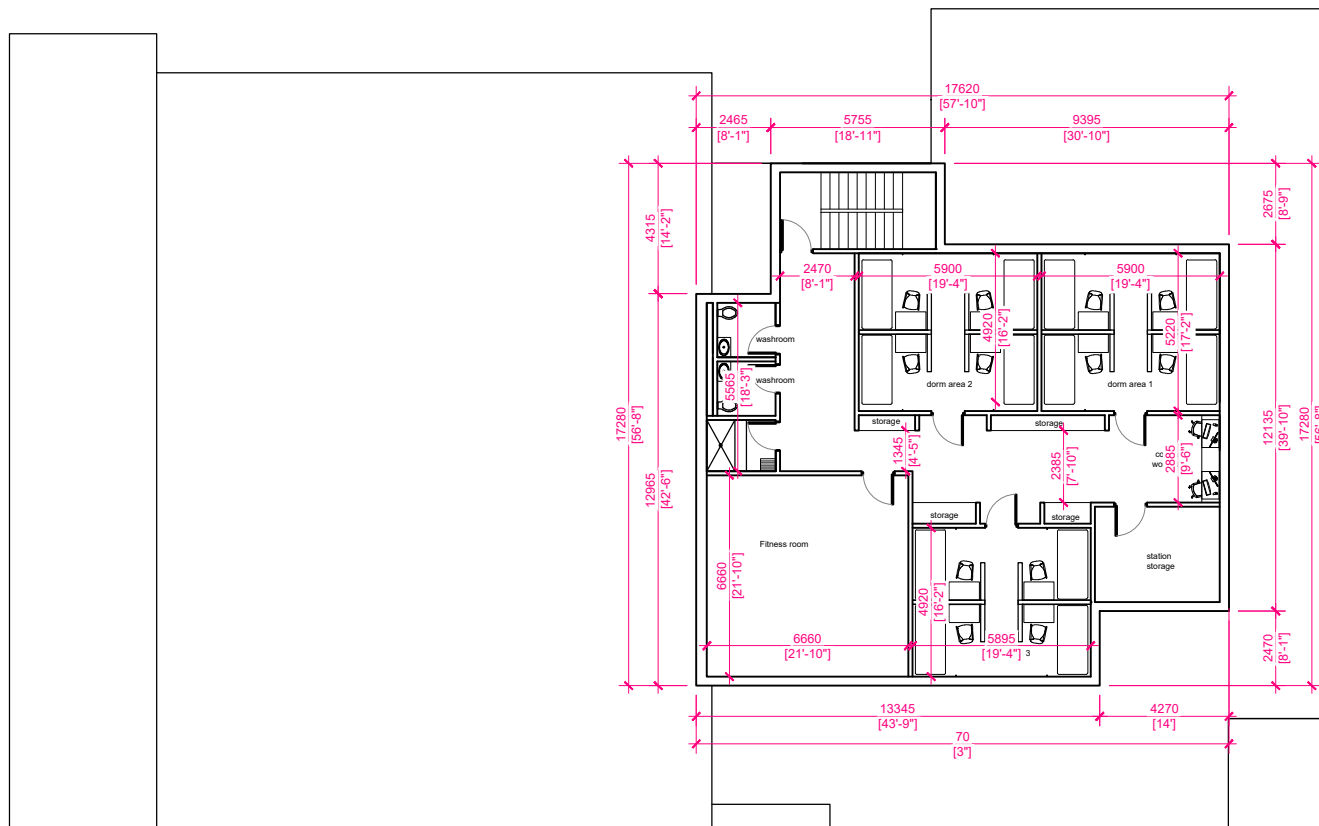

three truck two storey - floor plan - Level 2 - dimensioned  
 scale 1:250

## 4.5 area comparison plans

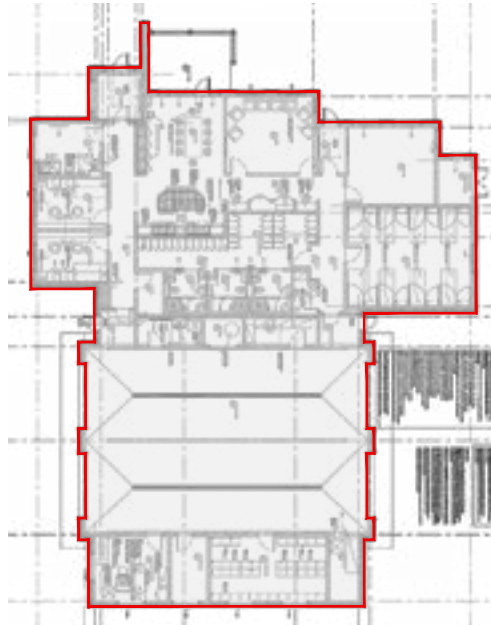

fire station 120  
762 sqm building footprint  
762 sqm gross floor area

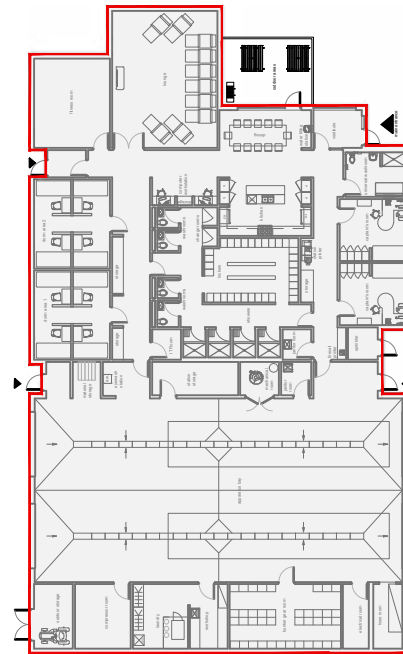

2 trucks -1 storey  
960 sqm building footprint  
960 sqm gross floor area

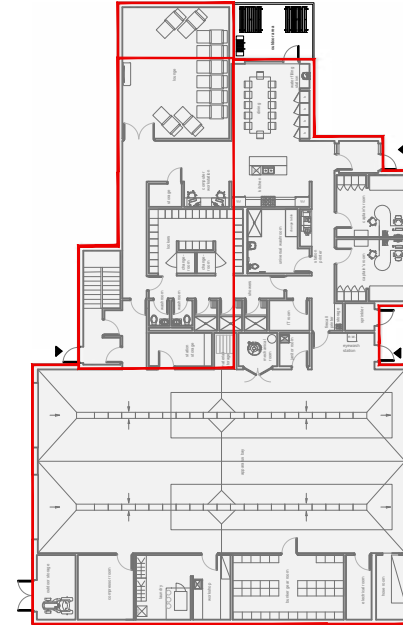

2 trucks- 2 storey  
825 sqm building footprint  
1002 sqm gross floor area

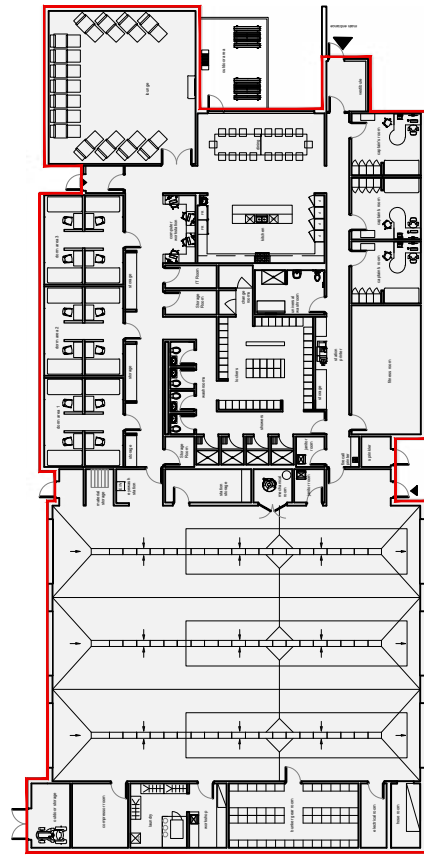

3 trucks - 1 storey  
 1313 sqm building footprint  
 1313 sqm gross floor area

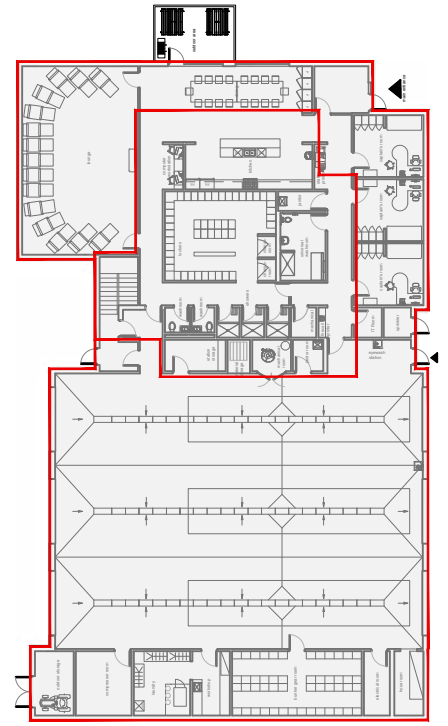

3 trucks - 2 storey  
 1087 sqm building footprint  
 1345 sqm gross floor area

## area comparison

Fire Station 120 (located at 125 Eglinton Ave W, Mississauga, ON) is the most recent fire station built by the City of Mississauga at the time of the development of this document. FS120 is a compact single storey two truck station.

The consultant team visited FS120 during the information gathering stage and recorded what was successful in the station's design and what needed improvement, and used this information as a benchmark in the development of the program and the floor plans.

The areas of some spaces developed for the two truck station floor plans in some cases exceed those reflected in FS120 for a variety of reasons listed below.

1. Captain's rooms to accommodate the accessibility requirement of a 2440mm turning circle.
2. Dayroom - lounge to accommodate more recliner chairs and training functions.
3. Dorm room - to accommodate separate sleeping area for each crew, permanent beds separated by low walls, and a desk and chair for each fire fighter.
4. Showers and washrooms to accommodate the separation of showers, toilets, and changing functions.
5. Apparatus bays to accommodate support vehicles
6. The addition of a compressor room.
7. A laundry room that supports an additional drying rack and clearances from the gear extractor.
8. A separate sprinkler room directly accessed from the exterior.
9. The addition of a material storage nook

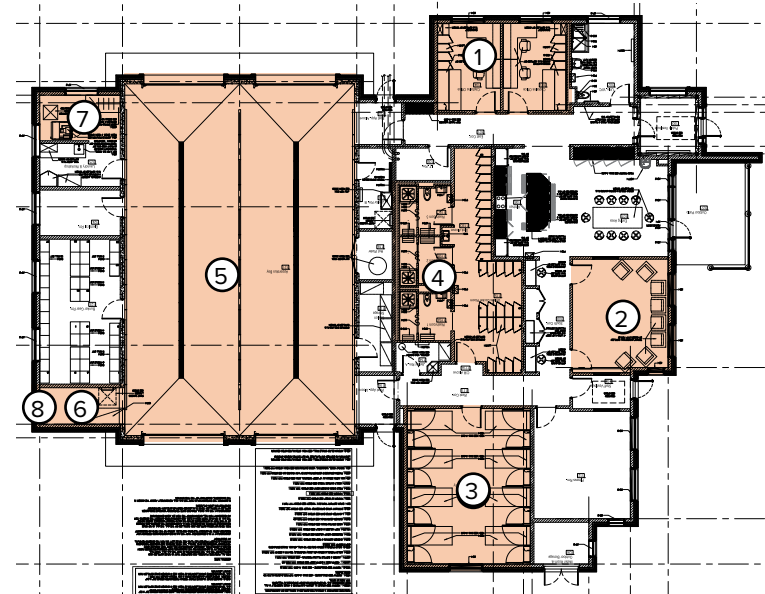

FS120 Ground Floor Plan  
Scale 1:400

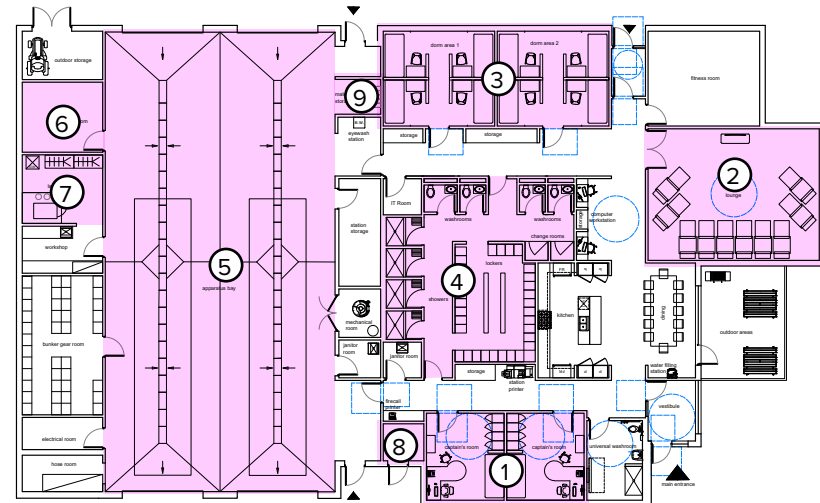

2 Truck 1 Storey Floor Plan  
Scale 1:400

Areas in the comparison chart below are shown in sqft.

	FS 120 Area	Proposed Design Area 2T1S	Proposed Design Area 2T2S	Proposed Design Area 3T1S	Proposed Design Area 3T2S
<b>GFA</b>	8202	10333	10785	14144	14477
<b>Building Footprint</b>	8202	10333	8880	14144	11700
<b>Cold Side</b>					
Vestibule/Lobby	Public Vestibule - 91.5 Staff Vestibule - 65 Front Apparatus Bay Vestibule - 65 Back Apparatus Bay Vestibule - 59	Public Vestibule - 86 Staff Vestibule - 57 Front Apparatus Bay Vestibule - 56 Back Apparatus Bay Vestibule - 45	Public Vestibule - 59 Staff Vestibule - 74 Front Apparatus Bay Vestibule -111 Back Apparatus Bay Vestibule - 100	Public Vestibule - 93 Staff Vestibule - 55 Front Apparatus Bay Vestibule - 56 Back Apparatus Bay Vestibule - 43	Public Vestibule - 119 Staff Vestibule - 75 Front Apparatus Bay Vestibule - 43 Back Apparatus Bay Vestibule - 86
Fire Call printer	10	51	43	46	47
Captains' Rooms	338	414	414	608	608
Dorm Room	579	637	663	995	975
Lockers	342	278	286	494	466
Showers and washrooms	242	300	325	456	423
Universal washroom	150	133	167	146	143
Captain's washroom					
Day Room-Lounge	313	678	678	1056	1027
Dayroom-Kitchen	245	254	244	406	301
Dayroom-Dining	311	291	284	313	328
Workstations	47	86	54	103	84
Outdoor Area	212	283	205	283	217
Gym	312	319	323	422	457
Sprinkler Room		45	38	45	38
<b>Hot Side</b>					
Apparatus Bay	2452	3181	3181	4773	4773
Hose Room	88	88	167	167	167
Bunker Gear Room	351	337	337	393	393
Gear washer/dryer/ laundry room	111	166	166	166	166
Shop	107	114	114	114	114
Compressor Room		170	170	170	170
Material Storage		47	39	47	39
<b>Support Spaces</b>					
Mech. room	50	61	61	61	61
Electrical Room	111	78	78	78	78
IT Room	54	42	42	55	40
Storage Room (hot)	90	136	99	136	90
Storage Rooms (cold)		108	75	200	198
Janitor Room (Hot)	90	47	47	47	45
Janitor Room (Cold)	45	40	46	41	44
Outdoor Shed	69	117	117	117	117





## 5.0 engineering guidelines

BOLD Engineering Inc. was retained by dpai architecture inc. on behalf of The City of Mississauga to provide an Engineering Feasibility Study in order to aid in the design of proposed layouts for new fire stations in order to meet the program requirements of the City of Mississauga Fire Department and associated stake holders. BOLD's review assesses Structural, Mechanical and Electrical systems of the proposed layouts.

The following engineering analysis is based on the program requirements outlined in the previous sections. In addition to this document, BOLD's analysis will take into consideration, the latest building codes (OBC, ESA, TSSA, ASHRAE, etc.), City of Mississauga accessibility standards and City of Mississauga – Corporate Green Building Standards.

Refer to Appendix B for The Structural Engineering Feasibility Review prepared by BOLD Engineering Inc.

Refer to Appendix C for The Mechanical Engineering Feasibility Review prepared by BOLD Engineering Inc.

Refer to Appendix D for The Electrical Engineering Feasibility Review prepared by BOLD Engineering Inc.

Refer to Appendix E for The Civil Engineering Feasibility Review prepared by BOLD Engineering Inc.

# 5.1 structural engineering guideline

## Superstructure – Main Building

1. The structure of the proposed building can be either (a) typical commercial construction, or (b) hybrid wood and steel frame construction.

**(a) Typical commercial construction** consists of square hollow structural steel (HSS) columns, concrete masonry unit (CMU) walls, a hollow core slab second floor supported by steel beams and corrugated steel roof decking supported by open web steel joists (OWSJ).

**(b) Hybrid construction** will include wood, steel and concrete. Timber framing (platform-frame construction) with wood studs, wood I-section joists and wood decking will be used throughout the building in conjunction with reinforced concrete masonry unit walls and some structural steel components.



Hip or gable-style roofs shall consist of wood roof trusses with either plywood or particleboard decking.

Flat roof structures may consist of wood I-section joists, glue-laminated beams (or steel girders) and either cross laminated timber (CLT) or particleboard decking.

Either steel or glue-laminated timber portal frames maybe used for the garage superstructure. The garage roof structure will consist of timber joists spanning between the portal frame girders and timber decking (plywood, particle board or cross-laminated timber panels).

It is recommended that the tower be constructed with steel HSS columns and beams. Braced frame construction is preferable for resisting lateral loads and limiting sway; however, a steel moment frame could also be considered acceptable provided it is designed to limit drift.

Alternatively, the tower’s columns could be constructed of glue-laminated timber sections, but steel bracing would be needed to limit lateral drift.

2. The structural steel will satisfy the requirements of CAN/CSA G40.21, Grade 350W.
3. The steel rebar will satisfy the requirements of CAN/CSA G40.21, Grade 400W.
4. The sheet steel used for decking shall conform to one of the following material specifications:
  - (a) ASTM A653/A653M Steel Sheet, Zinc-Coated (Galvanized) or Zinc-Iron Alloy-Coated (Galvannealed) by the Hot-Dip Process; or
  - b) ASTM A792/A792M Steel Sheet, 55% Aluminum-Zinc Alloy-Coated by the Hot-Dip Process.
5. The cladding or brick veneer will be tied to either 2x6 wood studs, light gauge steel studs or concrete masonry unit (CMU) walls with steel reinforcement at 400mm (16”) on center.

6. The flat sections of the building’s roof will have a corrugated steel roof deck supported by open web steel joist. The center to center spacing of the open web steel joists shall be between 3’-0” and 5’-6”, although there are steel decks with much greater allowable spans. This type of roof construction can be designed and modified to support rooftop condensers and air handling equipment.
7. Prefabricated wood roof trusses with plywood roof sheathing may be used for any hip, gable or sloped sections of the roof. Light-gauge steel trusses are considered an acceptable alternative to wood roof trusses. Please note that all lightweight roof framing and OWSJs must be designed for both snow loading and uplift.
8. The specified ground snow load and rain load are 1.1kPa and 0.4kPa for Mississauga. However, if the building is located south of the QEW, the specified ground snow load can be reduced from 1.1kPa to 0.9kPa because there is less snow accumulation in the areas of Mississauga located near Lake Ontario. This would apply for any fire stations constructed in the communities of Clarkson and Port Credit.
9. Lateral loads applied to the building will be transferred from the roof diaphragm to either steel bracing or concrete masonry unit (CMU) infill walls tied to the building’s steel frame. In CMU walls, it is anticipated that every other masonry core will be filled with grout and steel reinforcement.
10. The lateral load resisting system will consist of both steel bracing and reinforced concrete masonry unit (CMU) shear walls, and it must be checked against both wind and earthquake loading.
11. The structural design loads have been outlined in the chart below.

Proposed Building -Design Criteria	
<b>Dead Loads</b>	
Roof (Deck, Mod-Bit, Insulation, M&E Allowance)	1.45 kPa

<b>Specified Live Loads</b>	Value
Fire Truck Parking Area	12.0 kPa
Dorm Rooms	2.4 kPa
Fitness Room	4.8 kPa
Washroom / Toilet Areas	2.4 kPa
Mechanical Equipment Rooms	3.6 kPa
Corridors, Common Areas, Etc.	4.8 kPa
<b>Snow Loads</b>	
Ss*, Ground Snow Load:	1.1 kPa
Sr, Rain Load:	0.4 kPa
* Ground Snow Load may be reduced to 0.9kPa for Port Credit, Clarkson and areas located south of the QEW.	
<b>Design Wind Loads</b>	
Wind Pressure (1/10y)	0.37 kPa
Wind Pressure (1/50y)	0.48 kPa
<b>Seismic Design Parameters</b>	
Seismic Spectral Acceleration: SA(T=0.2s)	0.280
Seismic Spectral Acceleration: SA(T=0.5s)	0.150
Seismic Spectral Acceleration: SA(T=1.0s)	0.065
Seismic Spectral Acceleration: SA(T=2.0s)	0.021
Peak Ground Acceleration, PGA	0.150
<b>Serviceability Limit States (SLS):</b>	
Allowable Live Load Deflection:	L/360

## Tower

1. A tower may be incorporated into the design of the new fire station as an architectural focal point and a place to dry the hoses.
2. It will likely include four (4) HSS 152x152 posts, w-shape beams and diagonal struts for bracing. Alternatively, glue-laminated columns can be substituted for the HSS posts; however, steel

bracing should be provided.

3. Braced frame construction is recommended for the tower, as opposed to moment frame construction. The critical base shear for the tower must be indicated on the drawings.

## Substructure / Foundations

1. The proposed foundations shall be constructed of 35MPa, Class C1 concrete with 5-8% air-entrainment, 19mm max. aggregate and a water to cement ratio (W/C) of 0.40.

The foundation walls and piers must be Class C1 concrete, which might not satisfy any of the green building standards. The hydraulic cement outlined above (20% OPC replacement) may be suitable for slab-on-grade construction, though not for any major structural element including footings, walls and piers.

2. The reinforcing steel will be Grade 400W deformed steel bars.
3. The new foundation walls shall be wide enough for brick veneer (or precast concrete cladding), air space, concrete masonry block infill walls, rigid insulation and interior drywall finish.
4. The frost line in Mississauga is 4'-0" below grade; therefore, the base of the footings must extend to a depth of at least 4'-0" to prevent frost heaving.
5. A full geotechnical investigation will be required at each specific site to determine the allowable bearing stress at a depth of 4'-0".
6. All steel and/or glue-laminated columns will require pier-style foundations with a spread-footing for distributing the load.
7. The strip footings for the foundation walls will be a least 4'-0" wide and the pier footings will likely be at least 4'-6" x 4'-6". These are approximate dimensions for discussion purposes. Detailed

design analysis by the Engineer of Record shall verify these requirements.

8. Compressible material, such as fine clay and organic material, shall be removed in order to prevent significant long-term settlement, also known as consolidation.
9. Please refer to the chart on the following page for design criteria.

Materials & Design Specifications	
<b>Fire Truck Parking Area</b>	
Slab Thickness	8" (200mm) min.
Welded Wire Fabric Reinforcement	6x6 - W6 x W6
Rigid Insulation	R10
Granular A or Crushed Stone	200mm
Proctor Value / Maximum Dry Density	100%
<b>Ground Floor - Occupant Area</b>	
Slab Thickness	5" (125mm) min.
Welded Wire Fabric Reinforcement	6x6 - W6 x W6
Rigid Insulation	R10
Granular A or Crushed Stone	200mm
Proctor Value / Maximum Dry Density	98%
<b>Steel</b>	
Structural Steel - Yield Strength	350MPa
Anchors	A307 Anchors
Bolts & Fasteners	A325 Bolts
<b>Concrete (For Slab on Grade)</b>	
Concrete Class	Class C1
28-Day Compressive Strength	35MPa
Max Aggregate	20mm
Air Entrainment	5-8%
Water to Cement Ratio (W/C)	0.40
Steel Reinforcement	400 MPa

## 5.2 mechanical engineering guideline

### Codes And Standards

1. Mechanical systems shall be in accordance with applicable codes and standards including, but not limited to:
  - a. Authorities Having Jurisdiction (local building department requirements, local fire department requirements, local by-laws).
  - b. City of Mississauga Energy Design Guideline
  - c. National Codes:
    - Air Conditioning and Refrigeration Institute (ARI)
    - American National Standards Institute (ANSI)
    - American Standard for Testing and Materials (ASTM)
    - iAmerican Society of Mechanical Engineers (ASME)
    - NFPA-13
    - Underwriters Laboratories of Canada (ULC)
    - National Plumbing Code
    - American Society of Heating Refrigeration and Air Conditioning Engineers (ASHRAE):
    - Canadian/American Air Balance Council (CAABC)
    - Canadian Standards Association (CSA):
    - CAN/CSA-B149.1-05, Natural Gas and Propane Installation Code.
    - Sheet Metal and Air Conditioning Contractors National Association (SMACNA)
  - d. Ontario:
    - Ontario Building Code (OBC)
    - Ontario Fire Code (OFC)
    - Ontario Electrical Safety Code
    - Operating Engineers Act
    - Ontario Ministry of Municipal Affairs and Housing (MMAH) - SB-10

### Outdoor & Indoor Design Conditions

1. The sizing of mechanical systems shall be based on the outdoor air conditions shown in the following table:

	Dry Bulb Deg.C (Deg.F)	Wet Bulb Deg.C (Deg.F)
OUTDOOR	Heating/Cooling	23 (73.4)
INDOOR	-20 (-4.0) / 31 (87.8)	
General Living Area		
Sleeping Areas/Fitness	22 (72) / 25(77)	
	22 (72) / 22 (72)	
Truck Bays	20 (68) / NA	
Equipment Storage		

2. Ventilation for acceptable indoor air quality shall conform to the following:
  - a. Ventilation to meet acceptable indoor air quality shall be in accordance with ASHRAE Standard 62 and the applicable building code.
  - b. Air handling units are to be complete with Economizers to make use of free cooling and ventilation during the shoulder seasons.
  - c. Humidification; General living/sleeping areas, fitness and kitchen areas are not typically provided with central humidification however spaces to adhere to ASHRAE standard. A humidification unit can be installed in mechanical rooms or in the ceiling plenums with the steam manifolds in the ductwork serving the living and sleeping quarters. The humidification level be controlled by a local thermostat.
  - d. Standard 55: Thermal Environmental Conditions for Human Occupancy.

### HVAC

1. The fire station is a multipurpose building, which includes living areas, training, community education, equipment and vehicle storage, and hazardous material storage. The building is divided into Hot and Cold zones and is described as follows:
 

Hot Zone:

  - Apparatus and Maintenance Bay
  - Equipment Storage area
  - Laundry and Janitor Rm

Cold Zone:

  - Living/ Sleeping areas
  - Shower and Change Rooms
  - Offices
  - Kitchen
2. The HVAC system should be designed to prevent cross-contamination from hot area to cold area. Positive pressure is to be maintained in the Cold area to minimize contamination from Hot areas.
3. The HVAC system will consist of forced air heating and cooling system in the Living areas typically by a high-efficiency packaged rooftop gas heating, electric cooling unit. Consideration should also be given to a hybrid heat pump rooftop with supplementary gas-fired heater. Gas-fired infrared heaters in the Truck Bays.
4. All HVAC units will be of the highest efficiency available and all rooftop units are to be complete with economizers, enthalpy controller, 24-hour programmable thermostat, carbon dioxide (CO2) sensor.
5. Packaged rooftop units shall have Energy Recovery unit system with enthalpy wheel installed.
6. All ductwork terminating in perimeter wall or roof will be complete with external insulation 10 feet upstream of the roof/wall opening.
7. All HVAC equipment to within allowable noise criteria.



8. The HVAC system will be balanced by a certified air balancing contractor.
9. All equipment will have a startup test report for the contractor to fill in and submit for the engineer's review and will be included in the Operations and Maintenance (O&M) Manual.
10. Apparatus Bay:
  - a. Ventilation is typically supplied by the large truck bay door, and outdoor wall louvre connected to ductwork serving the truck bay. The outside air will be supplied without heat. The louvre dampers are interlocked with the general exhaust CO NOX removal system and the dedicated vehicle exhaust system. PCI is the preferred vendor by MFES for vehicle exhaust. The exhaust fans are to be located on the roof of the building to minimize noise.
  - b. General exhaust to be initiated by the CO or NOX sensors and to shut off when contaminant levels below that stipulated by code. General exhaust and interlocked outdoor air motorized damper to operate only when CO and/or NOX concentrations exceed preset levels. A manual pushbutton override is also to be provided to allow the system to operate for a preset time. The vehicle exhaust capture system is to be with a rail the full length of the bay and with pull-through capabilities.
  - c. Vehicle Exhaust; If the bay door opens the vehicle exhaust fan and the outside air dampers are to operate on a timed cycle. A manual pushbutton override is also to be provided to allow the system to operate for a preset time. New vehicle exhaust system installations to be compatible with fire department vehicle exhaust systems installed at other fire department facilities to allow exhaust tailpipe connection to any fire department vehicle.
  - d. Apparatus bay is to be under negative pressure relative to the rest of the facility.
  - e. Heating Source is to be gas-fired infrared heaters to run the length of the truck bay. Preferably one heater per truck bay. The combustion flue pipe is to terminate up through the roof.
  - f. Provide ceiling fans in cages for air circulation in the bay, fans are to be low velocity and volume.
11. Bunker Gear Room
  - a. The room is to be negative pressure and is to have an exhaust fan located on the roof. This room can be heated by a gas-fired heating unit, it should not be served a packed heating/cooling unit. Cooling is not required in this room. Provide door grilles or transfer air duct to allow air from adjacent areas.
  - b. Install two-speed exhaust fan on the roof, the fan will operate at high speed with wall mounted push button operator and will continue to run for 1 hour and then will slow down to low speed for all other times.
12. Laundry Room
  - a. The laundry room will have a gas-fired heating only unit, and a transfer air ductwork to allow ventilation into the room. The clothes dryer unit will be connected to a booster fan interlocked to the operation of the dryer unit.
13. Support Spaces
  - a. Support spaces such as a mechanical room, electrical room, storage room and janitor

rooms will have heating and no cooling. The electrical room will have an exhaust fan with a reverse acting thermostat to engage when room temperature reaches 82 deg F. The janitor room will have an exhaust fan that exhaust to outside, the fan operation will be interlocked with a light switch, and fan will set to disengage 30 mins after lights off. There will be no mechanical services provided for the outdoor shed.

#### 14. Cold Area (Living Area/ Office/ Kitchen/ Rec Rm)

- a. The Cold area will be served by a packaged rooftop unit with heating and cooling. The ductwork distribution from the rooftop unit will extend into the ceiling space of the area and flex ductwork to terminate at ceiling mounted diffusers. The return air is collected ceiling-mounted egg-crate grille and into the ceiling plenum. The return ductwork from the RTU's will extend approximately 10feet into the ceiling plenum where all return is to be collected.
- b. The rooftop unit system will be designed to provide more supply air than return air. Units dampers will be adjusted to created positive pressure within the Cold area to prevent contaminations from the Hot Areas.
- c. All supply and return will be acoustically insulated 10 feet downstream of the unit and all units are to be vibration isolation.
- d. The carbon dioxide sensor is to be installed in the return ductwork upstream of the RTU.
- e. The rooftop units are to be installed on roof curbs that are minimum 14" height, for a large unit where open structural frame support is required, provide a minimum 3 feet clearance from the top of roof level to the underside of the equipment.
- f. Do not locate rooftop units oversleeping quarter.
- g. A separate rooftop unit is to be provided

for interior and perimeter zones. A variable air volume (VAV) and or by-pass box is recommended for each room. A VAV system is preferred since it allows for energy saving by reducing the fan RTU fan speed as well as improved temperature control. The entire perimeter space can be served by one RTU with VAV boxes for each room with its designated thermostat. The interior space can be served by the second RTU, and it also too has the option of a VAV system but is not necessary.

- h. Ceiling fans can be installed in the sleeping room for better air movement (caged for safety).
- i. In Sleeping room, install wall supply and return air grilles on wall to minimize ductwork runs, incorporate the Coanda effect to throw air across the room where possible.
- j. In the Kitchen, a over the range hood will be installed that will terminate out through perimeter wall or roof. The fan will be in the range of 200-300 CFM. There are no additional exhaust requirements. The supply air will be the central rooftop unit.
- k. The Gym room will be served by the perimeter RTU and will have a designated VAV box. In addition to this, it is recommended ceiling fans be installed for improved airflow as well as a 1.5-ton split system air condition unit with the condensing unit on the roof. The AC can be either wall-mounted or installed in the ceiling with supply ductwork.
- l. The IT Room will have a designated exhaust fan with a reverse acting thermostat and a 1 Ton split system air conditioning unit. The exhaust fan will be the primary unit to maintain space temperature and the AC as supplementary cooling. The exhaust from the IT room will be discharged into the ceiling plenum.
- m. All vestibules will have electric forced flow

heater with designated thermostats, no cooling is to be provided.

- n. In the Locker room, supply air will be from the interior RTU, the exhaust will be a roof-mounted 2-speed exhaust fan. The exhaust will operate at high speed during the daytime and at low speed during the night. The fan will operate continuously for 24 hours.
- o. The washroom will only have a roof-mounted exhaust fan serving this area, each washroom stall will have an exhaust grille connected to the ductwork to the fan. Fan operation will be controlled by the occupancy light and the fan will be set to turn off 30 minutes after the lights. Exhaust ductwork 10feet upstream of the roof opening will be thermally insulated.

## Plumbing

1. The incoming cold-water service will be 2" and will be brought into the mechanical room and connected to the water meter with backflow preventer assembly. The water meter will have a remote readout on the outside of the building provided by the local utility provider and installed by a mechanical contractor. Refer to green building standards section below for more information.
2. Sprinklered buildings will have a designated incoming fire protection line with its water meter and backflow preventer, this is will be determined by site services engineer. Combined domestic water and fire protection is not recommended as municipalities require incoming fire protection water to be metered complete with shut-off valves which is currently in contradiction to NFPA. Sprinklers shall be required only as determined by the architectural OBC matrix.
3. The leaving buried sanitary and storm drain service will connect to city street drain connection and will be coordinated with site services drawings to match service location. Both storm and sanitary drain

pipng will be 6" diameter leaving the building.

4. All plumbing piping downstream of the water meter will be insulated and sized according to the flow rates.
5. Shut-off valves will be installed at each plumbing fixture and the hot water tank.
6. All plumbing piping will be labeled with direction arrows.
7. Apparatus Bay will be provided with 12" wide trench drains. The Bay drainage water will discharge into sediment and oil interceptors. Hot water will be provided by natural gas high-efficiency water heater/storage tanks with recirculation hot water pumps. A mixing valve shall be installed to control water temperature. The recirculation pump will be located in the mechanical room close to the hot water tank. The hot water combustion flue will terminate out through the perimeter wall.
8. All toilets are to be a wall-mounted, flush valve with an electronic (hard wired) flush.
9. All sanitary vent pipe up through the roof will be 3" diameter and will be installed over the washroom, janitor room, and mechanical room.
10. Non-freeze hose bibs will be installed on the building perimeter (locations to be determined on a project basis). The final locations shall be decided by the town. The recommended locations are in front of apparatus bay, back of apparatus bay, outside the facility part of the building (north side of the building) and office area (south side of the building).
11. For truck washing, a high-efficiency hot water tank shall be used. Natural gas is used for the heaters..
12. All plumbing fixtures will be high-efficiency low flow, commercial grade. Coordinate with the owner for final fixture selections. Natural gas service will be connected to gas-fired equipment (water heater and tube heaters). The fire station building will be served

with dedicated gas service.

13. Truck washing points, compressed air outlets and truck fill provisions shall be provided within the Bay area. One washing station is recommended for apparatus bay. Hot and cold water shall be connected to the wash station with a mixing valve. Compressed air connection shall be finalized by the fire station staff
14. Eyewash station with mixing valve to be installed in the Apparatus Bay.
15. Bottle fill drinking fountain station installed in the Exercise Room and the Kitchen.
16. All roof drain locations will be determined by the architect and all roof drains are to control flow type. Piping from roof drains will be combined into multiple risers and connect at the buried level. All horizontal storm drain piping is to be insulated.
17. Dishwasher piping rough-in to be designed adjacent to the kitchen sink. Engineering to provide piping detail drawings.
18. A gas meter is located outside adjacent to the building facing the road. Gas piping enters the building and extends up through the roof. All gas piping is distributed at the roof level, and thru the roof to serve the infrared gas heaters.

### Fire Protection

1. The building will be sprinkler as per NFPA13 and OBC. Location of sprinkler system assembly will be located in the mechanical incoming service room. Dry sprinklers shall be installed in areas where freezing is concern and also in the entrance vestibule.
2. All areas with T-bar ceiling and drywall ceiling will be fully recessed sprinkler heads, all areas without ceiling will have upright sprinkler heads.
3. All sprinkler heads are to be standard coverage for ordinary hazard classification.

4. Fire extinguishers will be installed in Kitchen, hallways, Apparatus Bay, and Mechanical/Electrical room. Fire extinguishers are to be Class ABC.

### Building Controls

1. A central building automation system (BAS) is not required.
2. Rooftop units will be controlled by a programmable thermostat.
3. Radiant gas-fired tube heaters and unit heaters will be controlled by programmable thermostats installed in local areas.
4. Exhaust fans will be controlled by 24-hour timer located in the mechanical room.
5. Hot water recirculation pump will have a integral controls with a digital screen for system manipulation.



## 5.3 electrical engineering guideline

### Site Electrical Services - Power

1. Coordinate with Local Utility, including service application for building.
2. Provide concrete pad / grounding for Local Utility pad mounted transformer as required by local utility standards. If a pad mount transformer is required, the exact location shall be coordinated on site with the local utility, City of Mississauga Planning Department and Engineer of Record as part of the Site Plan Approval (SPA) process.
3. Provide duct bank and feeders from the pad mounted transformer / pole mounted transformer to the main disconnect, in the proposed electrical room ideally located within the Apparatus Bay as close as possible to the building perimeter and as close as possible to the utility transformer location. Coordinate exact requirements with Local Utility.
4. Provide the Main Disconnect and Customer Metering Cabinet and Meter as per Local Utility standards.
5. A facility grounding system shall be provided in order to establish a low impedance ground path for equipment grounding. The grounding system shall include connections from the main switchboard to an under ground, cold water pipe, and building steel. Supplement the grounding system with a ground rod placed near the main switchboard. All grounding electrode connections shall be by irreversible exothermic welds.
6. Provide a ground bond per Ontario Electrical Safety Code (OESC) requirements to all metallic systems which may become energized (gas piping, fire sprinkler piping and the like). Provide ground bars in each Server Room backboard and Main Telecommunications Terminal Backboard (MTTB) connected to the main disconnect ground terminal.

### Site Electrical Services - Lighting

1. The goals of the site lighting shall include the following:
  - Provide a safe and secure environment;
  - Minimize environmental concerns (light trespass) of the neighborhood and the community in general; the foot-candle level shall be no greater than 0.1 foot-candles at the property line.
  - All exterior lighting shall be zero cut off.
  - All exterior lighting shall be dark sky compliant
  - Provide light of sufficient quantity and quality for security cameras (as required);
  - Draw visitors to the entries;
  - Provide sufficient light while keeping a low visual profile to the community;
  - A system which is maintainable;
  - Low energy consumption through the use of efficient sources.
2. All exterior lighting sources shall be Light Emitting Diode (LED).
3. Provide building mounted lighting utilizing vandal resistant type luminaires for exterior egress lighting and general lighting at walkways surrounding the buildings. Building entries shall have a minimum of 5 foot-candles. Exterior walkways shall have an average maintained light level of 1 foot-candle with a minimum of .25 foot-candles.
4. Exterior lighting shall be provided with time-based switching relay lighting control panel for control of the exterior area lighting. Provide a 2-hour by-pass wall switch adjacent to the lighting control panel for use in maintaining exterior luminaires.
5. Final design shall provide adequate coverage for service receptacles recessed mounted on pole mounted pole lights. This shall be determined during the detailed design stage by the electrical consultant.

### Site Electrical Services - Communications

1. Coordinate with local telecommunications utility companies for new underground services to building. Provide all trenching, boxes and raceways as required.
2. Demarcation location shall be the IT room.
3. Provide 2 hour fire rated back board in IT room for Communication Utility termination.

### Building Electrical - Power

1. Detailed design package shall include a complete single line diagram with equipment and feeder sizing, panel schedules, and a project load summary.
2. The final detailed design package shall include site distribution layout and electrical room layouts.
3. The final detailed design package shall be submitted by the Engineer of Record to the Electrical Safety Authority (ESA) for Plan Review.
4. The final design package shall include a short circuit / coordination study and arc flash analysis.
5. The main electrical service and main Disconnect are estimated to be rated at 400A, 120/208V, 3 phase, 4 wire.
6. The facility shall be providing with an emergency full backup natural gas generator on site external to the building footprint that meets the total power required of the full facility complete with an automatic transfer switch.
7. Provide separate panel boards for Receptacle, Lighting, and Mechanical loads. Surface or Recessed mounted in proposed electrical room. Provisions shall be made for load monitoring and metering of large loads in accordance with the City of Mississauga Green Design Standards. Refer to section 2.12 of this report for further detail.



8. Power conductors will be stranded, copper, type THHN/THWN insulation, rated for 600V. No aluminum wires or cables shall be allowed. All conductors will be routed in a wire way, or conduit. Flexible conduit shall be used for equipment connections. Electrical metallic tubing (EMT) shall be used for concealed lighting and receptacle branch circuits. Wherever possible, conduit will be concealed within construction. Conduits shall not be allowed to be placed in concrete slabs or decks. Where conduit is exposed below 8-feet, galvanized rigid steel conduit (GRC) or intermediate metal tubing (IMT) will be used. Use of Metal Clad (MC) cable is prohibited. Flexible Metallic Conduit (FMC) conduit will be allowed for minimal use where construction methods dictate the need. Steel insulated compression type conduit fittings shall be used. Polyvinyl chloride (PVC) conduit shall be used underground with GRC conduit for sweeps and risers. Corrosion resistant tape wrap will be applied to underground GRC.
9. The branch panels shall serve necessary wiring devices for equipment and convenience power. Branch circuits shall be run in metallic conduit

(PVC where routed below grade). The amperage, voltage, NEMA configuration of the wiring devices (receptacles) shall be as required by the equipment nameplate / cord set. 120V duplex receptacles shall be 15A minimum, specification grade.

10. Power connections to systems furniture shall be hard-wired, coordinate points of connection with furniture installer. (If any).
11. Provide power feeder to mechanical and plumbing equipment as required. Include safety disconnects at each piece of equipment. Provide receptacles within 25 feet of mechanical equipment; at exterior locations provide weather resistant receptacles with ground fault interrupter and while-in-use weather proof covers.
12. Receptacles will be provided in all areas as required by the stake holders. All wiring devices shall be specification grade. Workstations shall be provided with multiple receptacles served from general use panel boards. Provide dedicated neutral conductors with receptacle branch circuits.
13. Provide miscellaneous power circuits and connections to A/V equipment, phone / data

equipment racks, mechanical control panels and the like. The detailed design shall coordinate project needs in each space with the Owners and end users and (at minimum) provide the following:

- General convenience outlets connected with no more than (4) to a 15A branch circuit.
  - Dedicated receptacles/branch circuits where needed. (i.e. printers, copiers, shredders, office equipment, appliances, equipment, etc.)
  - Coordination with low voltage systems contractors / vendors and dedicated circuits / connections to equipment panels. (i.e. Security, Energy Management System, etc.)
  - Coordination with Owner's Information Technology (IT) representative for dedicated circuits/receptacles for data racks, grounding, etc.
14. Detailed design shall include provisions for feeder and automatic transfer switch as required to suit owner's emergency generator requirements.
15. Provide Electrical Power Distribution System per OESC standards.
- Voltage Drop, Feeder conductors shall be sized for a maximum voltage drop of 2 percent at design load. Branch circuit conductors shall be sized for a maximum voltage drop of 3 percent at design load.
16. Provide ceiling suspended retractable cord reel in apparatus bays located in non-drive lane locations, mounted to structural ceiling framing. Cord reels shall be quick disconnect type with minimum 45' cord length.



## Building Electrical – Power (Emergency)

1. The entire facility requires emergency backup power. A Kohler / Sommers / Generac or equivalent full back up onsite outdoor natural gas generator shall be installed in a suitable outdoor location on the property external to the building footprint to be coordinated as part of the Site Plan Approval Process.
2. The generator shall be mechanically protected by bollards and / or concrete curbs.
3. The natural gas supply shall be monitored by the generator's alarm system and / or fire alarm system as determined required during the detailed design stage. The alarm output shall be coordinated with project stake holders.
4. The generator's capacity is estimated to be 100KW, 120/208V, 3PH, 4W.
5. The generator enclosure shall be a weather proof sound attenuated enclosure. The sound attenuation rating shall be in line with site specific requirements such as proximity to neighboring properties and property types. If required detailed design analysis

shall include a noise study to determine required sound attenuation.

6. The emergency generator secondary feed shall be installed below grade, via underground duct banks into the electrical room ideally located within the Apparatus Bay as close as possible to the building perimeter and as close as possible to the utility transformer location. The feed shall terminate at the emergency supply of the Automatic Transfer Switch (ATS).
7. The ATS will automatically detect a utility power failure and switch on the generator, transferring electrical load to the emergency service within 10-20 seconds.
8. The generator's fuel supply shall be natural gas. As we are recommending a natural gas generator, we do not need to consider fuel supply capacity.
9. Ontario is considered as a reliable natural gas service jurisdiction for life safety and non-life safety emergency loads, meaning only a catastrophic interruption in natural gas service distribution system will affect the generator fuel supply.
10. At this time, we do not recommend specifying a life safety rated generator, as there are few actual

life safety loads within the facility. Only emergency lighting loads are required to be life safety rated and so for the cost of a few battery packs, there can be significant savings in power distribution costs by rating the generator as a simple non-life safety backup generator and installing a few emergency lighting battery packs.

## Building Electrical – Lighting

1. All interior lighting sources shall be Light Emitting Diode (LED).
2. Personal Offices, Open Offices, Conferences, Kitchen, Data and Training Rooms shall be designed for average maintained light level of 50-55 foot-candles.
3. The apparatus bay shall be designed for average maintained light level of 80-100 foot-candles.
4. Ancillary spaces, such as Janitor's Rooms, Electrical and Mechanical Rooms, Lobbies and general Storage area shall be designed for average maintained light level of 35-40 foot-candles.
5. Restrooms shall be designed for average maintained light level of 35-40 foot-candles.

6. Egress lighting shall be provided throughout the facility by means of unit equipment. (i.e. 120-minute battery packs integrated into the facility luminaires and exit signs with battery back-up). The design shall provide the minimum egress light levels per OBC along the entire egress path of travel. Provide exterior egress lighting at egress points (exits) and where there is a change in grade. Basis of design: Exit Signs shall be Bagheli, Stanpro or approved equivalent.
7. Lighting control shall include but not be limited to the following:
  - Dual tech occupancy sensors with manual on and automatic off in:
    - i. Private Offices.
    - ii. Sleeping Areas – Automatic off only (No Auto on function)
    - iii. Fitness Studio
    - iv. Lounge Areas – Automatic off only (No Auto on function)
    - v. Utility Spaces
  - Manual light switch control in:
    - i. Kitchen Areas
    - ii. Apparatus Bays
    - iii. Corridors
  - Day light sensing and automatic dimming during day light hours of selected fixtures to save on energy.
  - Lighting in all dorm room shall be linked to the fire fighter call system and complete with gradual dimming system.
  - Dimming shall be designed for the following areas:
    - i. Dorm / Sleeping Areas
    - ii. Lounge
8. Primary lighting fixtures being utilized shall be 1'x4', 2'x2' and 2'x4' LED troffers, and High Bay LED Fixtures (to be determined during detailed design).

9. All fixtures shall maintain a consistent lighting temperature of 3500K.
10. All fixtures shall have a CRI rating of 90.
11. All lighting control design shall conform to ASHRAE – Chapter 9.

### Building Electrical – Communications

12. All UTP Category 6 cabling shall be installed in accordance with ANSI/TIA/EIA 568C requirements. System shall be supplied by one manufacturer end-to-end, to ensure clarity in troubleshooting and compatibility of all components.
13. Route all cables to maintain minimum separation from sources of interference such as lighting, power cables, HVAC and other electrical equipment. Avoid cross-overs and congestion.
14. All data, voice and AV cables shall be pulled in continuous runs; no in-line splices are allowed.
15. Installer shall be certified by the manufacturer to install, test, and warrant the system, and shall provide certification documentation at closeout.
16. Supports: Provide cable supports, harnesses, and sleeves as required. All free running cables shall be securely fastened to appropriate cable supports and harnesses with maximal inter-support cable sag of 150mm. all cables shall be completely supported by the harnesses so that no weight is transferred to any other existing fixture or ceiling space structure. Cable supports shall be caddy cablecat or equivalent.
17. Labeling: Each horizontal cable and patch cord shall be affixed with mechanically printed labeling tabs or typed letter self-adhesive mylar at both ends. (The lettering shall not be exposed). Each cable and termination jack shall be labeled with a mechanically printed identification label. Cable labels to be self-laminating vinyl construction with white mark-on colour and clear overlaps. Cable

label shall be a minimum of 2" (50mm) wide and of sufficient length to permit clear overlap to be wrapped completely around cable at least one and a half times.

18. Labeling Scheme: Data cables: D.X-1 to 100; Voice cables: V.X-1 to 100, where letters and numbers denote: 'D' - data cable, 'V' - voice cable, 'X' - floor number, next number denotes cable number.

### Building Electrical – Communications

1. All UTP Category 6 cabling shall be installed in accordance with ANSI/TIA/EIA 568C requirements. System shall be supplied by one manufacturer end-to-end, to ensure clarity in troubleshooting and compatibility of all components.
2. Route all cables to maintain minimum separation from sources of interference such as lighting, power cables, HVAC and other electrical equipment. Avoid cross-overs and congestion.
3. All data, voice and AV cables shall be pulled in continuous runs; no in-line splices are allowed.
4. Installer shall be certified by the manufacturer to install, test, and warrant the system, and shall provide certification documentation at closeout.
5. Supports: Provide cable supports, harnesses, and sleeves as required. All free running cables shall be securely fastened to appropriate cable supports and harnesses with maximal inter-support cable sag of 150mm. all cables shall be completely supported by the harnesses so that no weight is transferred to any other existing fixture or ceiling space structure. Cable supports shall be caddy cablecat or equivalent.
6. Labeling: Each horizontal cable and patch cord shall be affixed with mechanically printed labeling tabs or typed letter self-adhesive mylar at both ends. (The lettering shall not be exposed). Each cable and

termination jack shall be labeled with a mechanically printed identification label. Cable labels to be self-laminating vinyl construction with white mark-on colour and clear overlaps. Cable label shall be a minimum of 2" (50mm) wide and of sufficient length to permit clear overlap to be wrapped completely around cable at least one and a half times.

7. Labeling Scheme: Data cables: D.X-1 to 100; Voice cables: V.X-1 to 100, where letters and numbers denote: 'D' - data cable, 'V' - voice cable, 'X' - floor number, next number denotes cable number.

## Building Electrical – Fire Alarm And Life Safety

1. Where required by OBC Architectural Matrix, detailed design shall include a complete fire alarm riser diagram showing fire alarm devices and annunciator panel zoning schedule.
2. The fire alarm system design shall be submitted as part of the building permit application. These documents shall be produced and signed by a licensed Professional Electrical Engineer licensed for the Province of Ontario.
3. The equipment and installation shall comply with the current provisions of the following standards and codes:
  - a. Underwriters Laboratories Inc. Standards:
    - ULC shall list the system and all components for use in fire protective signaling systems. The ULC label shall be considered as evidence of compliance with this requirement. the equipment shall be listed by ULC under the following standards as applicable:
      - CAN/ULC-S527 Control Units for Fire Alarm Systems
      - CAN/ULC-S529 Smoke Detectors for Fire Alarm Systems
      - CAN/ULC-S530 Heat Detectors for Fire Alarm Systems
      - CAN/ULC-S525 Audible Signal Appliances for Fire Alarm Systems
      - CAN/ULC-S528 Manual Pull Stations for Fire Alarm Systems.
      - CAN/ULC-S548 Alarm Initiating and Supervisory Devices for Water Type Extinguishing Systems
      - CAN/ULC-S536 Inspection and Testing of Fire Alarm Systems.
      - CAN/ULC-S524 Installation of Fire Alarm Systems
      - CAN/ULC-S537 Verification of Fire Alarm Systems
4. All control panel assemblies and the connected automatic and manual alarm and notification appliances shall be designed and manufactured by the same company; shall be tested and cross-listed as to ensure that a fully functioning life safety system is designed and provided.
5. The fire alarm/life safety system supplied under this specification shall be a microprocessor-based, addressable fire alarm / life safety system.
6. All fire alarm equipment shall be arranged and programmed to provide a system for the early detection of fire, the notification of building occupants, the automatic summoning of the local fire department, the activation of other auxiliary systems to inhibit the spread of smoke and fire, and to facilitate the safe evacuation of building occupants.
7. A standby power supply shall automatically provide electrical energy to the system upon primary power supply failure. Standby power supply shall be an electrical battery with capacity to operate the system under maximum supervisory load for 24 hours, and capable of operating the system for 30 minutes in the alarm mode at 100% load. fire alarm system shall include a charging circuit to automatically maintain the electrical charge of the battery.
8. All equipment furnished for this project shall be new and unused. All equipment, materials, accessories, devices, and other facilities covered by this specification shall be the best suited for the intended use and shall be the product of a single manufacturer.
9. In cases where a maglock is required, the Engineer of Record shall be responsible for notifying their engineer of record for submission for building permit.

## Security And Access Control

1. All security and access control systems shall be designed and installed in accordance with the City of Mississauga Corporate Security Standards.
2. A CCTV security camera system shall be installed to monitor the exterior perimeter of the facility. This CCTV system shall be networked with the City of Mississauga Corporate Security Office. Recording and record storage parameters shall be determined during detailed design and in consultation with facility stake holders.
3. Additionally, CCTV cameras shall be installed on the exterior of the building covering the parking lot.
4. A dedicated security camera shall be installed in the main entrance vestibule with feed to the Captains office.
5. Intrusion system is to be installed within the facility with the following standards:
  - All doors leading to the exterior installed with door contact,
  - All areas with window access to have glass break with motion sensors.
  - Long range motions are to be installed in the truck bay.
  - Pin pad to be installed beside the overhead bay door upon exit to arm and disarm the facility

6. Card readers shall be installed on the following doors:
  - Main entrance vestibule (interior door).
  - Rear entrance personnel door(s).
  - Front overhead doors (all)
  - Rear overhead doors (all).
  - Any interior doors requiring special access (TBD during detailed design).
7. Door Contacts shall be installed on all doors where card readers are installed. Door contractors shall monitor door status of these doors.
8. Piezo (audible) alarms shall be installed on all man doors such that they will sound when a door has been left opened for a preset amount of time. This shall be monitored by the door access control system.
9. Electrical strikes shall be preferred to Maglocks where possible. Either electric strikes or maglocks shall be installed on doors requiring card readers.



### General Electrical

1. The electrical design shall meet all applicable Codes.
2. Lighting design shall meet the recommendations of the current edition of Illumination Engineering Society of North America (IESNA). The design team shall be responsible for producing point-by-point photometrics to justify the final lighting layouts to meet the Owner's needs.
3. Exterior Luminaires shall meet IESNA "cut-off" definition.
4. The electrical installation shall be tested by an independent testing agency as approved by the City of Mississauga (as required). Testing shall include but not be limited to: the grounding system, testing and coordination of main overcurrent protection devices, feeders greater than 200 amperes, emergency systems (egress lighting) and UPS systems, etc.
5. Final installation shall be certified by ESA. A copy of all ESA certificates shall be provided to the City for record.
6. The emergency lighting installation shall be tested by an independent testing agency as approved by the City (as required). Testing shall be completed to ensure the operation and minimum run time is met according to the design intent and OBC.
7. The data and cabling installation shall be tested by an independent testing agency as approved by the City (as required). Provide test reports for both data and voice cabling. UTP Cat 6 testing shall include: attenuation; near-end crosstalk (next); insertion loss; power sum next (PS-NEXT); return loss (RL); equal level far end crosstalk (ELFEXT); power sum elfext (PS-ELFEXT); far end crosstalk (FEXT); attenuation to crosstalk ratio (ACR); power sum attenuation to crosstalk ratio (PSACR).
8. Electrical distribution equipment shall be from Eaton, Cutler Hammer, Schneider or approved equivalent product line for switchboard, transformers, panel boards, and disconnect switches and the like.
9. Occupancy sensors shall be designed based upon Lutron, Crestron and Acuity Products or approved equivalent. Coordinate sensor placement with manufacturer's recommendations.
10. Wiring devices shall be designed based upon standard City of Mississauga preferred product standards where available.
11. Data cabling and communication devices shall be designed based upon Panduit, Belden and Commscope products or approved equivalent.
12. Fire alarm equipment shall be from Chubb Edwards, Notifier, Mircom or approved equivalent product line for fire alarm minihorns / speakers, manual pull stations, smoke alarms, heat detectors and the like.
13. The fire alarm installation shall be tested by an independent testing agency as approved by the City (as required). Provide a fire alarm verification report to the Owner for their review and record.
14. Coordinate with Communication Designer for conduit requirements between Main Telecommunications Terminal Backboard "MTTB" in the Electrical room and Server Room.
15. Coordinate all communication requirements with the City for any specialty equipment requirements in regards to server, UPS, patch panels, server cabinets, backboards and the like.
16. Coordinate all Video and Audio requirements with the City for all HDMI, Data and specialty outlets required.
17. Coordinate with all disciplines, (i.e., Plumbing, Mechanical, Landscape, Civil, etc.) for connection to all equipment requiring power.
18. Coordinate with Security Consultant for conduit requirements for all security device rough-ins.
19. Provide rough-ins for break in detection on all doors.

## 5.4 civil engineering guideline

### Civil And Site Landscaping – Vegetation

1. Soft landscaping features will include trees, shrubs, plants and vegetation native to the area. The focus will be on the use of resilient indigenous species rather than invasive species or exotic plants that require special care and protection during the winter. All vegetation located in close proximity to the parking lot will be resistant to water with high concentrations of salt and chloride, due to the heavy use of de-icing salts during the winter.
2. The landscaping plan must indicate soil volume, species and quantity for each planting area. It is also to include a comprehensive plant list, provided including both common and scientific names of each plant, and highlighting all pollinator-friendly and native species.

### Civil And Site Landscaping – Stormwater Management

1. Based on the square footage of the building and the size of the parking lot, a number of precast concrete catch basins will be provided for storm water collection.
2. The surrounding parking lot and any flat roofing must have a minimum slope of 1:50 or 2% to ensure the water can drain.
3. Rainwater will be collected by eaves troughs and downpipe for all sloped roofing. Flat roofs will require either (i) scuppers with heat-tracing and exterior downpipe or (ii) interior roof drains that tie into a storm drainage system. This system is to be designed to reduce stormwater peak flow and runoff volume from the site by promoting the natural hydrological cycle.

4. All soft and hard landscaping should slope away from the foundation wall to direct all storm water run-off away from the building. In order to reduce the build-up of pore water pressure against foundation wall, it is recommended that drainage material, such as gravel or crushed stone, be used as backfill against the side of the building. A perforated drainage pipe or weeping tile located against the side of the strip footing can be also used help reduce pore water pressure. The drainage pipe must be connected to either (i) a sump pit from which water can then be pumped out, or (ii) one of the catch basins.
5. Historic rainfall data for the project location is to be referenced; comprising of data gathered over at least ten years of data and collected from a consistent source. The rainwater management plan will calculate the runoff volume to be managed on site, which depends on post-development site conditions including the amount of paving, permeability of surfaces, roof area, and amount of vegetation. With this information the storm management plan will be designed, utilizing a combination of green infrastructure and low-impact development strategies to replicate the site's natural hydrological cycle and reduce the peak flow and runoff volume
6. During construction an Erosion & Sediment Control plan is to be established to ensure stormwater runoff during this phase does not transport sediment to the existing municipal infrastructure. Catch basin sediment control devices shall be used within the existing site and the adjacent area, in addition to sediment control fence around the perimeter of the site and a mud mat at the construction entrance. These control measures are to notated on the site plan.

### Civil And Site Landscaping - Hardscaping

1. All roadways and driveways shall be designed to service heavy duty vehicles including tri-axle salt trucks and fire engines used by the City's operations. This will likely require the use of additional gravel (or Granular A) and Granular B. Each lift must be compacted to at least 98% maximum dry density (Standard Proctor Value). Adequate measures shall be taken to ensure water is not able to pool at the base material below the granular road make-up.
2. The parking lot pavement will likely consist of the following:
  - 2" HL3 Wearing Course;
  - 2" HL8 Base Course;
  - 150mm Gravel or Granular A compacted to 98% Std. Proctor Value; and
  - 150mm Granular B compacted to 98% Std. Proctor Value.
3. The driveway area directly in front of and/or behind to the apparatus bay doors is to be composed of a concrete slab apron. This concrete apron shall provide a platform that is more durable than asphalt. This area outside the apparatus bay is needed as an area where fire trucks can be parked without damaging the asphalt driveway (while on standby, for cleaning, maintenance, etc.). This concrete apron will likely consist of the following:
  - 200mm Thick Concrete slab – 35 MPA, 5-8% entrained Air with Epoxy coated 15M reinforcement @ 300mm O/C each way – Top & bottom.
  - 400mm Granular A compacted 98% Std. Proctor Value
4. The pavement and slab designs outlined above are conceptual only and shall not be included in

the final design specifications until OBC, municipal and geotechnical requirements are thoroughly reviewed.

5. The sidewalks will be 5mm thick, Class C1 concrete with 5-8% air entrainment and 6x6-W1.4xW1.4 welded-wire mesh. A basecourse consisting of 6" of Granular A and 6" of Granular B compacted to 98% Std. Proctor is recommended.
6. All roadways and driveways shall be designed to have permeable pavement surfaces. Permeable paving systems consist of porous material that enables stormwater to flow through it or nonporous blocks spaced so that water can flow between the gaps. Permeable paving systems can reduce surface runoff and improve water quality by filtering pollutants in the subsurface layers. Examples of permeable pavement include the following:
  - Pervious concrete; and
  - Porous asphalt.

### Civil And Site Landscaping – Bicycles And Electric Vehicles

1. The site design will accommodate electrical vehicle transportation. However, it is imperative that any electrical charging equipment in the parking area will not interfere with fire trucks ability to maneuver in the parking area.
2. The site is to incorporate sufficient infrastructure to support bicycle transportation. The site plan is to have notations indicating location, number, and type of bicycle parking spaces, as well as, notations indicating location and number of shower and change facilities.
3. The bicycle storage area is to include regular electrical outlets to accommodate the charging of electrical bicycles





appendix A **program development chart**



	MODEL PROGRAM DEVELOPED IN BCA	OUTLINED IN RFP	FS120 NOTES	FS 4-7 City of Vaughan 835 Nashville Rd, Woodbridge	Final
<b>General Information</b>					
Occupant Load	All fire stations to be outfitted to accommodate 2 crews 10 people / shift = 8 fire fighters + 2 captains Each station has 4 platoons total number of individuals = 40 = 32 fire fighters and 8 captains			This fire station only has one truck active. (4 24-hour shifts) There are two extra bays, one is used to store the heritage truck for public engagement, one bay available for new apparatus.	All fire stations to be outfitted to accommodate 2 crews per truck 5 people/crew = 4 fire fighters + 1 captain  Total number of individuals for a 2 truck fire station: 10 people/shift = 8 fire fighters + 2 captains 2 shift change = 20 people  Total number of individuals for a 3 truck fire station: 15 people/shift = 2 fire fighters + 3 captains 2 shift change = 30 people
Accessibility Requirements	Per City of Mississauga 2015 Facility Accessibility Standards Section 4.5.11 Fire Stations:  Municipal fire stations should accommodate the accessibility needs of potential facility users (while supervised), including but not limited to:				Per City of Mississauga 2015 Facility Accessibility Standards Section 4.5.11 Fire Stations:  Municipal fire stations should accommodate the accessibility needs of potential facility users (while supervised), including but not limited to:
	Injured staff attending a Captain's office or other meeting space within the facility;				Injured staff attending a Captain's office or other meeting space within the facility; Accessible path of travel to be provided to Captain's offices, universal washroom, and day room.
	Administration staff, Council Members, Consultants, etc attending site visits;				Administration staff, Council Members, Consultants, etc attending site visits;
	Tours of non-work staff (School groups, etc.);				Tours of non-work staff (School groups, etc.) An accessible path of travel to be provided to kitchen and lounge area (training area)
	Occasional uses of the facility. Fire stations contain spaces that may be used by the public while supervised by staff; and				Occasional uses of the facility. Fire stations contain spaces that may be used by the public while supervised by staff; and
	Use by members of the general public in an emergency situation				Use by members of the general public in an emergency situation. Fire stations are post-disaster buildings, thereby, should perform as a barrier free space.
	Pedestrian walk-up &/or vehicular drop-in requests for assistance/emergency services;				Pedestrian walk-up &/or vehicular drop-in requests for assistance/emergency services;
	Areas of fire stations likely to be used by the public, including the apparatus bay, should be accessible for persons with disabilities.				Areas of fire stations likely to be used by the public, such as the apparatus bays and universal washroom, should be accessible for persons with disabilities.
	Facilities not required to be accessible are those for the exclusive use of firefighters such as hose towers, fitness rooms, 2nd floors, dormitories, and any basement level storage space.				Facilities not required to be accessible are those for the exclusive use of firefighters such as hose towers, fitness rooms, 2nd floors, dormitories, and any basement level storage space.
	Fire stations to ideally be on a single level to prevent tripping hazards.		station on one level		Fire stations to ideally be on a single level due to response time and to prevent tripping hazards.



	MODEL PROGRAM DEVELOPED IN BCA	OUTLINED IN RFP	FS120 NOTES	FS 4-7 City of Vaughan 835 Nashville Rd, Woodbridge	Final
	Public entrances shall be accessible Firefighter entrances shall be accessible per the City of Mississauga FADS, except that a power door operator is not required, unless it is required by the Ontario Building Code.				Public entrances shall be accessible Firefighter entrances shall be accessible per the City of Mississauga FADS, except that a power door operator is not required, <b>unless it is required by the Ontario Building Code.</b>
	An accessible path of travel shall be provided from accessible public entrances to all spaces that are accessible to the public or intended for access/viewing by visitors. Where more than 3 entrances are provided, minimum 2 barrier-free entrances are required (per OBC).				An accessible path of travel shall be provided from accessible public entrances to all spaces that are accessible to the public or intended for access/viewing by visitors. These spaces include the day room and apparatus bays. Where more than 3 entrances are provided, minimum 2 barrier-free entrances are required (per OBC).
	Spaces that may be used by community and public within fire stations shall be accessible.				Spaces that may be used by community and public within fire stations shall be accessible.
	Common-use areas within a fire station, such as the kitchen, shall comply with all relevant sections of this Standard.		The kitchen did not seem to be designed to accessibility standards outlined in FADS.		Common-use areas within a fire station shall comply with all relevant sections of this Standard. However, the kitchen area is not required to be fully accessible with specialty designed millwork and appliances.
	Where public parking is provided, at least one accessible parking space shall be located close to the primary public entrance.		barrier-free parking space near the public entrance with a braille strip leading all the way to the public entrance doors		Where public parking is provided, at least one accessible parking space shall be located close to the primary public entrance. Provide a braille strip leading from the accessible parking to the public entrance doors
<b>Cold Side</b>					
Vestibule/Lobby	Front Entrance reconfiguration to include for emergency lock (outdoor door unlocked at all times with thumb turn on interior – the purpose is for the vestibule to serve the public in cases of emergency providing a secure lockable area from external danger) Entrance should be accessible		4 entrances: 1 public entrance, 1 staff entrance, and 2 entrance vestibules on the front and rear of the apparatus bay	1 public entrance - safe zone, always unlocked exterior door - need to be buzzed in by staff. Large windos - bright welcoming entrance, BF parking nearby. 3 staff exits throughout (1 at far side of apparatus bay off workshop/hose tower, 1 off lounge area, 1 off kitchen for patio access.. 2-storey atrium at entrance - seems very spacious but lots of light from clerestory windows. can see straight through building, with glass wall enclosing fitness room and more large windows to the exterior. Noted no elevator access to 2nd floor space	Front Entrance reconfiguration to include for emergency lock (outdoor door unlocked at all times with thumb turn on interior – the purpose is for the vestibule to serve the public in cases of emergency providing a secure lockable area from external danger). Interior door designed with panic hardware, dry sprinkler, pedimat, and security camera. Entrance should be accessible automatic door operator
Fire Call printer	To be placed near access to the apparatus bay from the day room		placed near access the apparatus bay closest to the captain's office	placed near access the apparatus bay	

	MODEL PROGRAM DEVELOPED IN BCA	OUTLINED IN RFP	FS120 NOTES	FS 4-7 City of Vaughan 835 Nashville Rd, Woodbridge	Final
Captains' Rooms	each captain has a separate room with a murphy bed, night stand, 4 lockers (1/captain), desk, computer, chair, printer, and TV	Two station captains offices	each room has 2 chairs, 1 desk. A filing cabinet, murphy bed, 4 lockers, a white board.  <i>the room was initially designed with a longer desk but it was later modified to a standard desk and the filing cabinet was added</i>	One captain room , complete with desk, murphy bed, storage, ensuite washroom with shower. Windows to exterior have shades as well as black-out blinds in track for sleeping.	each captain has a separate room with a bed, 4 full lockers (18") (1/captain), desk, computer, chair, printer, writable and tackable surfaces, 4-up filing cabinet, operable windows, black out shades  Captain's desk to be facing door.
Dorm Room	fire fighters have a shared dorm room that contains for each person: a murphy bed, night stand or table & chair beside each bed, and one 15" locker. Total beds, night stands=8 Total lockers= 32	Dormitory;	the dorm room has no lockers. murphy bed millwork includes a nighstand and a reading light. The millwork doors when opened act as privacy screen between each bed.  The murphy bed millwork has a flat top that is being used as a makeshift storage shelf, which should be avoided for safety reasons.  Question for whether a foldable murphy bed is necessary if the room is only used for sleeping.	dorm has no lockers - 5 actual beds (not murphy) with side table - c/w partial height walls between beds to give some private areas if firefighters want personal space during shift - not just used for sleeping time.  Noted drywall was interesting but wonder about durability/ length of time desired to be effective.	fire fighters have a shared dorm room that contains individual sleeping areas. For each person, a sleeping area includes: an outlet for each bed with combo usb outlet, desk, chair,night light reading lamp, and clothing hooks near each bed. Sleeping areas are separated by a 4' wall on each side. For a 2 truck station: Total of 8 beds, 8 desks, 8chairs For a 3 truck station: Total of 12 beds, 12 desks, 12chairs Dorm is subdivided by occupants of each truck. No carpet in dorm area; door lite required for H&S reasons; night lite low at floor, humidity control, and fan for air circulation and white noise.

	MODEL PROGRAM DEVELOPED IN BCA	OUTLINED IN RFP	FS120 NOTES	FS 4-7 City of Vaughan 835 Nashville Rd, Woodbridge	Final
			<p>Better lighting requested overall:                      The doorlite was blocked off with duct tape to keep light out. Doors to dorm area should not have lites in them.                      The edges of the window's blackout screen were also taped to keep leaked light out.                      The ceiling lights in the dorm room are very bright and do not provide a lower light level option.</p> <p>There were wall reading lights for every Murphy bed permanently installed at 48 in AFF.</p> <p>Floor fan was placed in the room. Request to include a fan preferably wall-mounted (with cage) and not ceiling-mounted in the sleeping room to provide both white noise and air circulation.</p>	<p>Night lights (red) will operate at night automatically with alarm when call comes in.</p> <p>Chief recommends these be located low on the wall to light the floor rather than on the ceiling.</p>	
Lockers	<p>Lockers to be ideally placed in a separate space from sleeping area, grouped with washroom facilities.                      Locker facility should be accessible with at least 4 lockers to be accessible.</p>	Personal lockers	<p>Locker room adjacent to the washrooms. 52 Lockers are provided at 18" wide.  <i>a sink is provided in the locker room, but isn't being used.</i>  <i>Accessible lockers per standards outlined in FADS did not seem to be provided.</i></p> <p>No benches are provided in the locker room since changing happens in individual washrooms.  <i>Note: Consideration to provide a separate change room area instead of using washrooms for changing.</i></p>	<p>Lockers were combined with the Washroom/Shower facilities, and separated for men and women. It was noted that this limits the flexibility of staffing ratios, limits expansion. Nicely appointed rooms with nice tilework , lockers and showers - though not fully enclosed shower rooms (as same sex rooms).</p>	<p>Lockers to be 18", ideally placed in a separate space from sleeping area, grouped with shower and washroom facilities. Locker area to include benches and change rooms.                      Number of lockers? 32 for two truck and 48 for 3 truck?</p>



	MODEL PROGRAM DEVELOPED IN BCA	OUTLINED IN RFP	FS120 NOTES	FS 4-7 City of Vaughan 835 Nashville Rd, Woodbridge	Final
Showers and washrooms	Gender neutral individual stand-alone washrooms each with toilet, sink and shower. Minimum of 4.	Gender neutral washrooms; Communal change rooms with showers;	3 gender-neutral washrooms provided, each with toilet, sink, walk in shower and bench for changing.  <i>Shower draignage was an issue, and a curb has been added to stop water from flowing into the rest of the washroom.</i>  Washroom doors had a sidelite with frosted glass. Is this necessary?	as above - segregated	Four gender neutral, stand-alone washrooms each with toilet and sink. Showers, locker, and change areas are separated from washroom facilities.
Universal washroom	1 gender neutral universal washroom with toilet, sink, and shower. universal washroom does not require an adult-sized change table is (but space for an adult sized change table must be provided); and have a baby change table. Can serve as captains' washroom, or one of the gender neutral washrooms.	Barrier free accessible washroom;	<i>Note: the universal washroom might be oversized based on the reduced requirements in section 4.5.11 Fire Stations of the City of Mississauga FADS. Universal Washrom Requirements outlined in the OBC should take precedence over the reduced requirements. Adult change table is provided but the FADS reliquish the need to provide one if the space for one is provided.</i>	<i>UNiv. washroom adjacent to public entrance includes barrier free shower, but no table (conc. block could support), but no good location for table - would block access to shower).</i>	1 gender neutral universal washroom with toilet, sink, and shower. universal washroom does not require an adult-sized change table is (but space for an adult sized change table must be provided); and have a baby change table. Can serve as captains' washroom, and public washroom. Size to follow FADS.
Captain's washroom	Gender neutral individual washroom with toilet, sink and shower. Can double as the universal washroom.		The universal washroom acts as the captain's washroom	noted as ensuite to captains office/room.	Gender neutral individual washroom with toilet, sink and shower. Can double as the universal washroom.
Day Room (Kitchen /Dining/ Lounge)	Kitchen and Day room reconfiguration to provide comfortable space for a 10 staff  Lounge with 5 recliner chairs and built to accommodate a TV	Day room; Kitchen, kitchen storage and dining area	<u>Dayroom</u> is in a separate room from the kitchen and dining area. The dayroom has two doors, 8 lazy boy chairs, and a TV. <i>Note: the separate room is prefered as place for privacy and to control noise transfer between activities in different rooms. The room was a little tight for the chairs with two of the chair propping the doors open.</i>	Lounge with recliners, TV, black-out blinds and shades, coffered ceiling in lounge	Kitchen and Day room reconfiguration to provide comfortable space for: 10 staff for a 2 truck station 15 staff for a 3 truck station  Lounge with recliner chairs and built to accommodate a TV. Balance between visibility and separation - for training room purposes (presentations etc)

	MODEL PROGRAM DEVELOPED IN BCA	OUTLINED IN RFP	FS120 NOTES	FS 4-7 City of Vaughan 835 Nashville Rd, Woodbridge	Final
	<p>Kitchen counter tops need to be designed to AODA and accessibility standards</p> <p>Kitchen to contain lockable shift food lockers – 1 per platoon</p> <p>Kitchen to contain 2 fridges</p>		<p><u>Kitchen</u> contained two fridges, 1 dishwasher, and ample storage in upper cabinets, lower cabinets, and an island, and is considered a generally successful space.</p> <p>An additional dishwasher would be usefull since the one is heavily used.</p> <p>Fridges with water filling provided and require water lines. <i>Question if these are necessary since a separate water bottle filling station is also provided.</i></p> <p>4 full length shift food lockers provided. Note: JC mentioned a more functional apprach would be 2 lower and 2 upper shift lockers separated by a counter space.</p> <p>The kitchen did not seem to be designed to accessibility standards outlined in FADS.</p>	<p>one fridge, storage for 4 platoons in nice cabinetry, but locking not facilitated - using chain and combo lock) - no provision for barrier free workspace at counter.</p>	<p>Kitchen to contain lockable shift food lockers – 1 per platoon. Counter space required with upper and lower storage cabinets. Upper cabinets required in kitchen.</p> <p>2 Truck station:                      Kitchen to contain 2 fridges, water filling station, gas stove, dishwasher, and 4 storage cabinets.</p> <p>3 Truck station:                      Kitchen to contain 3 fridges, water filling station, gas stove, 2 dishwashers, and 5 storage cabinets.</p>
	<p>Dining table to seat 10 staff</p>		<p><u>Dining area</u> provided for 8 people. Note: This was considered on the smaller side, as room for at least 10 people is ideal. The dining table is also used during shift changeover for meetings and notes between the two platoons.</p>		<p>Dining table to seat:                      12 people for a 2 truck station                      17 people for a 3 truck station</p> <p>Provide white boards and tackboards in dining area</p>
	<p>Day Room area to accommodate 1 computer station and a shared central printing station</p>		<p><u>Work stations</u> are provided in two nooks in the hallway in front of the dayroom.  <i>The chairs for those workstations impede on the circulation space in the corridor. The desk space provided is limited. These desks are usually used as study spaces for professional development coursework.</i></p> <p>stand alone printer provided in the dining area</p>		<p>Day room area to be multi-use.                      Lounge area to accommodate enough room to train 10 fire fighters for a 2 truck station and 15 fire fighters for a 3 truck station.                      Intigrate computer stations with cisco webex requirements into day Room. Incorporate 2 computer workstations for a 2 truck station; 4 computer workstation for a 3 truck station.</p>





	MODEL PROGRAM DEVELOPED IN BCA	OUTLINED IN RFP	FS120 NOTES	FS 4-7 City of Vaughan 835 Nashville Rd, Woodbridge	Final
Outdoor Area	Accessed off the dayroom to accommodate 1 barbecue grill with a gas connection to have seating for 8-10 people.		Outdoor area provided with a grill with a gas connection. <i>The outdoor area was partially sheltered which isn't ideal from a security and privacy standpoint.</i>	off dining space/kitchen - BBQ will be provided. Noted gate to access parking/exterior from fenced patio space.	Outdoor area accessed off the kitchen; to accommodate 1 barbecue grill with a gas connection; and to have seating for 8-10 people for a 2 truck station, 15 people for a 3 truck station.
Gym	Gym / workout area large enough to accommodate equipment and 5 staff Equipment list: Power rack, bicycle, treadmill, rower, bench, a stability balls 75cm and 55cm, 3 tier dumbbell rack Approximate area= 35-40 sqm	Exercise area;	<i>The area provided was deemed adequate.</i>	Very spacious, large windows, full-height glazed wall on corridor. 1 rower 1 treadmill, exercise balls, free weights and rack machine. Training room separate on the 2nd floor - TV and storage, room for large table and chairs - not BF?	Gym / workout area large enough to accommodate equipment and 5 staff Equipment list: to be provided. Approximate area= 30 sqm for a 2 truck station =45 sqm for a 3 truck station
			<i>There was a request that lighting in common areas such as the kitchen and sleeping quarters be placed on dimmers. Also, multiple switching to be able to separate areas in common spaces so that not all lighting is on one switch.</i>  <i>Some rooms had too many PA speakers for their size.</i>		Lighting in common areas such as the kitchen and sleeping quarters to be placed on dimmers. Multiple switching to be able to separate areas in common spaces. Not all lighting is on one switch.
<b>Hot Side</b>					
Apparatus Bay	All apparatus bays to be upgraded to 2-fire trucks' and designed to aerial fire truck specifications;		2-fire truck bay designed to aerial fire truck specifications. Overall length is 61' .	3 bays, special bi-fold doors on street side \$\$\$, O/H doors on rear side, 2-storey height with high-level windows.	All apparatus bays to be designed to aerial fire truck specification. Trucks to drive in and out of apparatus bays rather than back in Apparatus bay door width to be roll up vs bifold doors, and to measure a min 4270W x 4270H. Card access on front and back man+ O/H doors Garage door openers on truck (remote controlled)
	Infrared heating system		The IR heating system was not the full length of the bay which was a coordination error in design. Emergency Vehicle Exhaust Capture System with a rail the full length of the bay and with pull through capabilities.		Infrared heating system to be full length of apparatus bay.
	Emergency Vehicle Exhaust Capture System with a rail the full length of the bay and with pull through capabilities		The exhaust system in the garage bays is manufactured by PCI. This is the preferred vendor. Try to locate the PCI exhaust fan motor on the roof rather than inside in order to minimize noise.		Emergency Vehicle Exhaust Capture System with a rail the full length of the bay and with pull through capabilities

	MODEL PROGRAM DEVELOPED IN BCA	OUTLINED IN RFP	FS120 NOTES	FS 4-7 City of Vaughan 835 Nashville Rd, Woodbridge	Final
	Hose rack for drying		hose storage and drying rack in a separate nook off the apparatus bay. The space provided is constricted by roof access ladder and sprinkler main.	Chief mentioned that everyone likes using the hose tower, as it provides a better system for drying hoses, but said that he wasn't sure it was possible based on available floor area. However, after viewing the hose drying racks you saw at the other station I would say we should at least look at the possibility as I don't believe the argument is in the floor area, but rather in the consideration of cost to building the 3-story height tower walls.	Hose tower for drying. Anchorage points for training within tower for each station. Consider full height as well as half height towers. Provide enough room for drying 1 hose/ truck and for storing 1 hose/2 trucks.
			There was a request for more ventilation in the garage bays even though by code it is not required due to the fact that required air changes are achieved by the opening and closing of bay doors.		Provide for air circulation in the summer through high level fans of high level windows. If fans are provided, they should be caged.
			Two Overhead power outlets. Design a breakaway electrical outlet in the bays that will cleanly break away from the fire truck when the fire truck is plugged in and needs to pull out quickly for a call.		Two Overhead power outlets. Design a breakaway electrical outlet in the bays that will cleanly break away from the fire truck when the fire truck is plugged in and needs to pull out quickly for a call.
	Eyewash station		eyewash station in apparatus bay. noted that eyewash station location was right next to the entrance / exit from vehicle which creates a pinch point functionally.		Eyewash station to be accommodated in apparatus bay. Its location to not impede on entrance/ exit areas.
	Other Items of Note		Green push buttons are provided at the bay doors where trucks exit which tie into the traffic signal box to stop pedestrian traffic		Green push buttons to be provided at the bay doors where trucks exit. These tie into the traffic signal box to stop pedestrian traffic and to ensure it is safe for the truck to go.
			Stove off push button provided in the access from the living area to the apparatus bay.		Stove off push button to be provided in the access from the living area to the apparatus bay.
			A push button provided once inside the bay area to acknowledge the call.		A push button to be provided once inside the bay area to acknowledge the call. Provide writable and tackable surfaces in apparatus bay.

	MODEL PROGRAM DEVELOPED IN BCA	OUTLINED IN RFP	FS120 NOTES	FS 4-7 City of Vaughan 835 Nashville Rd, Woodbridge	Final
Bunker Gear Room	Self-contained Bunker Gear Rm. complete with recirculation system. Racking system to accommodate minimum 80 gears for drying-40 racks at 24"x24". Bunker gear room to accessible from apparatus bays;	Separate vented room for bunker gear washing/drying/storage	Separate vented room off the apparatus bay. 40 24x24 inch metal storage racks provided. Combination of wall mounted and mobile racks. Floor drains provided in the room.  There was a request for more ventilation and perhaps negative pressure in the equipment room in order to help eliminate and contain equipment smells.	self contained with separate ventilation, noted high-quality lockers	Self-contained Bunker Gear Room complete with recirculation system. Combination of wall mounted and mobile racks. Racking system to accommodate minimum of:  40 racks at 20"d x 24"w for a 2 truck station. 50 racks at 20"d x 24"w for a 3 truck station. Bunker gear room to accessible from apparatus bays; floor drains provided in the room.
Gear washer/dryer/ laundry room	Stacked Washer & Dryer in an area accessible from apparatus bay		In a room off the apparatus bay. Stacked washer and dryer along with  A workbench and storage racks share the space with the laundry room.	directly off apparatus bay opposite side of bunker gear room	Stacked Washer & Dryer in an area accessible from apparatus bay
	also accommodates a Unimac gear extractor equipment and the support system infrastructure, along with a drying rack		a gear extractor and gear drying rack.  The gear extractor support slab is raised and was poured after the slab was poured, this is causing the two pours to slowly separate.  The gear extractor drains very quickly and requires a sufficient size drain. Right now, the drain they have cannot keep up.  There was limited room to store the laundry detergent jugs and they were balancing on the edge of the raised extractor slab support.  The room generally felt tight, and the gear dryer was squeezed into the space. Needs to accommodate a dryingrack in a separate closet.		also accommodates a Unimac gear extractor equipment and the support system infrastructure, along with 1 drying rack/ truck.  The gear extractor support slab is to be raised. The gear extractor drains very quickly,requiring a sufficient size drain.  Provide sufficient room to store the laundry detergent jugs and cleaning supplies.



	MODEL PROGRAM DEVELOPED IN BCA	OUTLINED IN RFP	FS120 NOTES	FS 4-7 City of Vaughan 835 Nashville Rd, Woodbridge	Final
Shop	Accessed off the apparatus bay, no access from the living areas. 2x3m area with 1 work bench and wall tool storage + 1 storage cabinet	Maintenance & repair workroom with janitor sink	work bench provided in the laundry room along with a sink. The workbench also housed charging station for radio batteries. <i>Note: consider better location for charging away from the sink. Staff want a defined area for charging of radios.</i>	next to hose tower, with access to exterior via person-door.	Accessed off the apparatus bay, no access from the living areas. Provide 1 work bench, wall tool storage, 1 storage cabinet, and a sink.
<b>Support Spaces</b>					
Mech. room	Rooftop units preferable to free up floor space. Mechanical room within the floor area to accommodate central vacuum and a hot water tank.	Mechanical room	HVAC is a rooftop unit. <i>Overall there was a request for more ventilation throughout above and beyond what's required by OBC.</i>  Hot water tank provided in a room off the bay. <i>The domestic hot water tank needs to have sufficient capacity to supply the equipment commercial washing machine.</i>	Roof top ERVs accessed off 2nd floor mech space with hot water tanks, elec. panels and IT boards	Rooftop units preferable to free up floor space. Provide sufficient ventilation for mechanical room. Mechanical room within the floor area to accommodate central vacuum and a hot water tank. The domestic hot water tank needs to have sufficient capacity to supply the equipment commercial washing machine.
Electrical Room		Electrical/IT room	Noted that ASCO automatic transfer switch is preferred. ASCO is the preferred vendor.	adjacent to Day room beside public entrance	Electrical room approximate area to be 10 sqm. ASCO automatic transfer switch is preferred.
IT Room					
Storage Room (hot side)	General storage, first aid supply storage, cleaning and housekeeping supplies and equipment storage		storage room provided off the apparatus bay and includes General storage, first aid supply storage, cleaning and housekeeping supplies and equipment storage. <i>The storage room is occasionally used to store donation items like toys and food.</i>	general storage dispersed around station, some in main lobby, some at day lounge, some at free-works space at lounge entry.	Provide a general storage space with mop sink. A separate first aid supply storage to be accommodated.
Janitor Room	to include a slop sink. slop sink can also be placed in shop or laundry room	Janitor sink in Shop	two janitor rooms provided one on off the appartus bay for the hot side and a separate one for the cold side. Cold side janitor room also housed the central vac unit	combined with clean laundry room (in clean area)	Janitor room to include a slop sink. If area allows, 2 janitor rooms are preferred (one on the hot side and one on the cold side)
Outdoor Shed	For storage		provided as a storage room on the exterior rear wall with outdoor access	n/a	Outdoor storage room to be provided with outdoor access.
<b>Site Access and Parking:</b>					

	MODEL PROGRAM DEVELOPED IN BCA	OUTLINED IN RFP	FS120 NOTES	FS 4-7 City of Vaughan 835 Nashville Rd, Woodbridge	Final
Parking	Ideally for 20 Vehicles. Minimum Parking for at least 14 vehicles. 1-2 barrier free parking spaces within 30m of entrance. A transition area to stack cars during shift change if less than 20 spaces provided Parking requirements to meet City of Mississauga standards with 2.6mx5.6m stalls and 7m aisles. Option for electric vehicles' charging station and the system infrastructure in support thereof	Vehicular parking and barrier free parking spaces.	22 total parking spaces. 20 for staff, 1 visitor, and 1 barrier-free sized at 2.7m x 5.2m for regular spaces, and barrier free at 4.9m wide. Drive aisle width at 7m.  No electric vehicle parking station provided. Review green standard for requirements of car charging stations.	parking for two shift overlap, 2 visitors plus 1 barrier free, no provisions for EV charging	Spaces for 2 truck 22 spaces. - 1BF  3 truck 32 spaces . 2BF  Car charging to comply to CGBS
Fire trucks	Fire trucks should have enough maneuvering space to be able to access the apparatus bays from the rear and exit from the front directly onto the road.	Drive through truck bays	site designed for a through bay design	noted that the rear approach to apparatus bay has a tight radius, large pad of concrete poured to handle weight and force of trucks, possible to use as training area or washing trucks outside	Fire trucks should have enough maneuvering space to be able to access the apparatus bays from the rear and exit from the front directly onto the road.
<b>Critical equipment &amp; systems:</b>					
Generator	All stations require a full back up generator on site natural gas generator in accordance with applicable codes, rules & regulations including TSSA requirements.	External generator	The generator was manufactured by Kohler. The backup generator is natural gas type.	York 125 located in rear parking lot beside hose tower	All stations require a full back up generator on site natural gas generator in accordance with applicable codes, rules & regulations including TSSA requirements.



appendix B     **structural engineering feasibility review**



**Bold Engineering Inc.**  
**2778 Dufferin Street, Suite 104,**  
**Toronto, ON M6B 3R7**  
**Canada**

T: 416-556-0766  
F: 1-866-876-5758

**ENGINEERING FEASIBILITY REVIEW – STRUCTURAL (FINAL)**  
**TEMPLATE DESIGN AND STANDARDS FOR NEW FIRE STATIONS**  
**2 TRUCK STATION – 1 STOREY OPTION**

**Prepared for:**

DPAI Architects  
1800-25 Main Street West, Hamilton, ON  
c/o: The City of Mississauga

Submission Date: October 27, 2020

**Prepared by:**

Bold Engineering Inc.  
2778 Dufferin Street, Suite 104  
Toronto, ON, M6B 3R7





**Bold Engineering Inc.**  
 2778 Dufferin Street, Suite 104  
 Toronto, ON M6B 3R7  
 Canada

T: 416-556-0766  
 F: 1-866-876-5758  
[www.boldengineering.ca](http://www.boldengineering.ca)

**CONTENTS**

1.0 EXECUTIVE SUMMARY .....3  
 2.0 STRUCTURAL .....4  
 2.1 GENERAL .....4  
 2.2 SUPERSTRUCTURE – MAIN BUILDING .....4  
 2.3 SUBSTRUCTURE / FOUNDATIONS.....7  
 2.4 CITY OF MISSISSAUGA – CORPORATE GREEN BUILDING STANDARDS .....9



## 1.0 EXECUTIVE SUMMARY

BOLD Engineering Inc. was retained by the DPAI Architects on behalf of The City of Mississauga to provide an Engineering Feasibility Study in order to aid in the design of proposed layouts for new fire stations proposed by DPAI Architects in order to meet the program requirements of the City of Mississauga Fire Department and associated stake holders. Our review will assess Structural, Mechanical and Electrical systems of the proposed layouts.

Our analysis is based on the program requirements outlined in the Template Design and Standards for New Fire Stations – Program Development Document developed by DPAI dated March 3, 2020. In addition to this document, our analysis will take into consideration, the latest building codes (OBC, ESA, TSSA, ASHRAE, etc.), City of Mississauga accessibility standards and City of Mississauga – Corporate Green Building Standards.

The proposed fire station layout for Option #1 is designed for 2 Trucks and 10 staff. During shift changes, the facility shall accommodate 20 staff. Locker facilities shall accommodate 40 staff. On the “Hot Side” the facility includes laundry and work shop facilities, a bunker room and utility spaces including: main electrical room, station storage, hot water room and janitor’s room. On the “Cold Side” the facility includes two (2) dorm rooms, fitness room, lockers and showers, washroom facilities, accessible (universal) washroom, computer work stations, two (2) captain’s rooms, kitchen and dining rooms, lounge, outdoor areas, IT rooms and janitor’s closet.

Detailed reviews of the Structural Systems are provided in the sections below.

Prepared by:

BOLD Engineering Inc.

A handwritten signature in black ink that reads 'S Black'.

Per:  
Stephen Black, P.Eng.  
Structural Engineer



## 2.0 STRUCTURAL

### 2.1 GENERAL

1. This narrative design analysis shall be used in conjunction with the Architect's drawings and plans, and with Mechanical, Electrical and Civil design narratives to develop a complete synopsis of the structural design guidelines for end user stake holder approval for concept design.
2. Final design documents shall be produced and signed by a licensed Professional Structural Engineer licensed for the Province of Ontario, retained by the City of Mississauga.
3. These Preliminary Structural Documents are not intended to reflect the complete requirements for construction documents. The final issued for construction detailed design drawings and specifications shall verify the project structural requirements and determine the arrangement, size and selection of structural members. The project design shall be in accordance with current applicable codes, standards and ordinances of the Province of Ontario, particularly Part-4 of the Ontario Building Code.
4. Unless specifically noted, shop drawings for all structural components identified in the *Issued for Construction* Drawings shall be produced by the supplier's engineer and approved by the structural engineer of record.
5. The structural engineer of record shall be responsible for determining the design intent of the new Fire Hall. This narrative shall be used only as a basis for design in accordance with the program requirements put forth by DPAI, BOLD Engineering Inc. and the City of Mississauga.

### 2.2 SUPERSTRUCTURE – MAIN BUILDING

1. The structure of the proposed building can be either (a) typical commercial construction, or (b) hybrid wood and steel frame construction.
  - a) **Typical commercial construction** consists of square hollow structural steel (HSS) columns, concrete masonry unit (CMU) walls, a hollow core slab second floor supported by steel beams and corrugated steel roof decking supported by open web steel joists (OWSJ).
  - b) **Hybrid construction** will include wood, steel and concrete. Timber framing (platform-frame construction) with wood studs, wood I-section joists and wood decking will be used



throughout the building in conjunction with reinforced concrete masonry unit walls and some structural steel components.

Hip or gable-style roofs shall consist of wood roof trusses with either plywood or particleboard decking.

Flat roof structures may consist of wood I-section joists, glue-laminated beams (or steel girders) and either cross laminated timber (CLT) or particleboard decking.

Either steel or glue-laminated timber portal frames maybe used for the garage superstructure. The garage roof structure will consist of timber joists spanning between the portal frame girders and timber decking (plywood, particle board or cross-laminated timber panels).

It is recommended that the tower be constructed steel HSS columns and beams. Braced frame construction is preferable for resisting lateral loads and limiting sway; however, a steel moment frame would also be considered accept provided it is designed to limit drift.

Alternatively, the tower's columns could be constructed of glue-laminated timber sections, but steel bracing would be needed to limit lateral drift.

2. The structural steel will satisfy the requirements of CAN/CSA G40.21, Grade 350W.
3. The steel rebar will satisfy the requirements of CAN/CSA G40.21, Grade 400W.
4. The sheet steel used for decking shall conform to one of the following material specifications:
  - a) ASTM A653/A653M Steel Sheet, Zinc-Coated (Galvanized) or Zinc-Iron Alloy-Coated (Galvannealed) by the Hot-Dip Process; or
  - b) ASTM A792/A792M Steel Sheet, 55% Aluminum-Zinc Alloy-Coated by the Hot-Dip Process.
5. The cladding or brick veneer will be tied to either 2x6 wood studs, light gauge steel studs or concrete masonry unit (CMU) walls with steel reinforcement at 400mm (16") on center.
6. The flat sections of the building's roof will have a corrugated steel roof deck supported by open web steel joist. The center to center spacing of the open web steel joists shall be between



3'-0" and 5'-6", although there are steel decks with much greater allowable spans. This type of roof construction can be designed and modified to support rooftop condensers and air handling equipment.

7. Prefabricated wood roof trusses with plywood roof sheathing may be used for any hip, gable or sloped sections of the roof. Light-gauge steel trusses are considered an acceptable alternative to wood roof trusses. Please note that all lightweight roof framing and OWSJs must be designed for both snow loading and uplift.
8. The specified ground snow load and rain load are 1.1kPa and 0.4kPa for Mississauga. However, if the building is located south of the QEW, the specified ground snow load can be reduced from 1.1kPa to 0.9kPa because there is less snow accumulation in the areas of Mississauga located near Lake Ontario. This would apply for any fire stations constructed in the communities of Clarkson and Port Credit.
9. Lateral loads applied to the building will be transferred from the roof diaphragm to either steel bracing or concrete masonry unit (CMU) infill walls tied to the building's steel frame. In CMU walls, it is anticipated that every other masonry core will be filled with grout and steel reinforcement.
10. The lateral load resisting system will consist of both steel bracing and reinforced concrete masonry unit (CMU) shear walls, and it must be checked against both wind and earthquake loading.
11. The structural design loads have been outlined in the chart below.

<b>Proposed Building -Design Criteria</b>	
<b><u>Dead Loads</u></b>	
Roof (Deck, Mod-Bit, Insulation, M&E Allowance)	1.45 kPa
<b><u>Specified Live Loads</u></b>	
	<b>Value</b>
Fire Truck Parking Area	12.0 kPa
Dorm Rooms	2.4 kPa
Fitness Room	4.8 kPa
Washroom / Toilet Areas	2.4 kPa
Mechanical Equipment Rooms	3.6 kPa



Corridors, Common Areas, Etc.	4.8 kPa
<b><u>Snow Loads</u></b>	
Ss*, Ground Snow Load:	1.1 kPa
Sr, Rain Load:	0.4 kPa
* Ground Snow Load may be reduced to 0.9kPa for Port Credit, Clarkson and areas located south of the QEW.	
<b><u>Design Wind Loads</u></b>	
Wind Pressure (1/10y)	0.37 kPa
Wind Pressure (1/50y)	0.48 kPa
<b><u>Seismic Design Parameters</u></b>	
Seismic Spectral Acceleration: $S_A(T=0.2s)$	0.280
Seismic Spectral Acceleration: $S_A(T=0.5s)$	0.150
Seismic Spectral Acceleration: $S_A(T=1.0s)$	0.065
Seismic Spectral Acceleration: $S_A(T=2.0s)$	0.021
Peak Ground Acceleration, PGA	0.150
<b><u>Serviceability Limit States (SLS):</u></b>	
Allowable Live Load Deflection:	L/360

### 2.3 SUBSTRUCTURE / FOUNDATIONS

1. The proposed foundations shall be constructed of 35MPa, Class C1 concrete with 5-8% air-entrainment, 19mm max. aggregate and a water to cement ratio (W/C) of 0.40.

The foundation walls and piers must be Class C1 concrete, which might not satisfy any of the green building standards. The hydraulic cement outlined above (20% OPC replacement) may be suitable for slab-on-grade construction, though not for any major structural element including footings, walls and piers.

2. The reinforcing steel will be Grade 400W deformed steel bars.
3. The new foundation walls shall be wide enough for brick veneer (or precast concrete cladding), air space, concrete masonry block infill walls, rigid insulation and interior drywall finish.



4. The frost line in Mississauga is 4'-0" below grade; therefore, the base of the footings must extend to a depth of at least 4'-0" to prevent frost heaving.
5. A full geotechnical investigation will be required at each specific site to determine the allowable bearing stress at a depth of 4'-0".
6. All steel and/or glue-laminated columns will require pier-style foundations with a spread-footing for distributing the load.
7. The strip footings for the foundation walls will be at least 4'-0" wide and the pier footings will likely be at least 4'-6" x 4'-6". These are approximate dimensions for discussion purposes. Detailed design analysis by the Engineer of Record shall verify these requirements.
8. Compressible material, such as fine clay and organic material, shall be removed in order to prevent significant long-term settlement, also known as consolidation.
9. Please refer to the chart on the following page for design criteria.

<b>Materials &amp; Design Specifications</b>	
<b><u>Fire Truck Parking Area</u></b>	
Slab Thickness	8" (200mm) min.
Welded Wire Fabric Reinforcement	6x6 - W6 x W6
Rigid Insulation	R10
Granular A or Crushed Stone	200mm
Proctor Value / Maximum Dry Density	100%
<b><u>Ground Floor - Occupant Area</u></b>	
Slab Thickness	5" (125mm) min.
Welded Wire Fabric Reinforcement	6x6 - W6 x W6
Rigid Insulation	R10
Granular A or Crushed Stone	200mm
Proctor Value / Maximum Dry Density	98%
<b><u>Steel</u></b>	
Structural Steel - Yield Strength	350MPa



Anchors	A307 Anchors
Bolts & Fasteners	A325 Bolts
<b><u>Concrete (For Slab on Grade)</u></b>	
Concrete Class	Class C1
28-Day Compressive Strength	35MPa
Max Aggregate	20mm
Air Entrainment	5-8%
Water to Cement Ratio (W/C)	0.40
Steel Reinforcement	400 MPa

## 2.4 CITY OF MISSISSAUGA – CORPORATE GREEN BUILDING STANDARDS

### 1. Cement for Super Structure:

#### a) Level 1:

Consideration should be given to replacing ordinary portland cement with 20% blast furnace slag, silica fume or fly ash. This involves the use of blended hydraulic cements, which often do not satisfy Class C1 and C2 requirements. They are acceptable for any slabs-on-grade supporting pedestrian traffic, but not heavy equipment or fire trucks. The proportioning and mixing of blended hydraulic cements are specified under ASTM C595.

Blended hydraulic cements produced from replacements exceeding 20% are generally not recommended for major structural components, because limiting the amount of ordinary portland cement can reduce the reactive ingredient - Lime (CaO) – needed for hydration to occur. Blast furnace slag, silica fume and fly ash all have pozzolanic properties, allowing them to behave like portland cement; however, they are not recommended for footings, piers and suspended slabs.

#### b) Level 2:

For concrete components with replacements exceeding 20%, slag is considered the preferable pozzolanic replacement material. Type IS (25) slag-based cement could be used. It should be noted that air-entraining admixtures will be needed for all outdoor applications.

Additional Cost: +10% above Level 1.





c) Level 3:

The following types of blend hydraulic cement are recognized and regulated by ASTM C595:

- Type IP cement is portland-pozzolan cement in which Ordinary Portland Cement (OPC) is mixed with a pozzolanic material, such as fly ash. (Replacement rates for type IP range from 15-25%.)
- Type IS cement is portland-slag cement in which ordinary portland cement (OPC) is blended with blast furnace slag in varying proportions ranging from 5-50%.
- Type IT cement is ternary cement consisting of ordinary portland cement blended with two different pozzolans, one of which is usually blast furnace slag. For example, Type IT (S25)(P15) is 60% OPC, 25% slag and 15% pozzolan (fly ash, silica, etc.).

In Ontario, most components require 5-8% entrained air; therefore, any air-entraining admixture must be compatible with the chosen hydraulic blended cement. As discussed previously, footings, piers and suspended slabs should be constructed of 35MPa Class C1 concrete made from ordinary Portland cement.

Level 3 is the highest Green Building Standard adopted by Mississauga, resulting in the smallest environmental footprint. Construction material requirements must conform to the requirements of the *International Living Future Institute's Living Building Challenge*.

Additional Cost: +20% above Level 1

2. Cement for Substructure / Foundations

a) Level 1:

MM-1: Replace Ordinary Portland Cement (OPC) with 20% blast furnace slag, silica fume or fly ash. This involves the use of hydraulic cements, which often do not satisfy Class C1 and C2 requirements. This is acceptable for any slabs on grade supporting pedestrian traffic, but not heavy equipment or fire trucks.

b) Level 2:

MM-1: Type IS (25) Slag-based cement could be used for sidewalks and any interior slab-on-grade not required to resist the load of a fire truck or any heavy equipment. Blended cements must be compatible with the air-entraining admixture. In Ontario, concrete usually

contains 5-8% air-entrainment to mitigate the problems that can arise from the freeze-thaw cycle.

c) Level 3:

MM-1: Refer to *International Living Future Institute's Living Building Challenge*. ASTM C595 governs the proportioning of blended hydraulic cement. Higher fraction replacements are used for non-structural components, sidewalks, curbs and interior slabs subject to standard occupant loads. The cements listed below the blended hydraulic cements in which ordinary Portland cement has been replaced with 40% pozzolanic material:

- Type IS (40)
- Type IT (S25) (P15)

3. Use of Wood

a) Level 1:

Use 25% FSC Certified Wood Products in construction. This is possible in many locations; however, it is recommended that the tower be constructed of steel.

b) Level 2:

Use 75% FSC Certified Wood Products in construction. This is suitable in many locations, with the exception of the tower, 2nd storey fitness centre and 2nd storey mechanical room. The 2<sup>nd</sup> storey fitness centre shall be built by using materials that limit the structural vibration. Structural steel and reinforced concrete are more suitable for this application. The 2<sup>nd</sup> storey mechanical room shall be built by using materials that can handle the weight of the mechanical equipment and machines. Wood products tend to be unsuitable to carry the machines' weight.

c) Level 3:

Satisfy the material requirements set out in the *International Living Future Institute's Living Building Challenge*. This may not be a practical alternative.

4. Use of Structural Steel

a) Level 1:

MM-4: The structural steel content must include 50% post-consumer recycled steel. Approximately 93% of structural steel is recycled and most structural steel contains some post-consumer content; however, a steel mill or steel fabricator should be consulted to

confirm that Grade 350 Weldable Steel can be produced from a large fraction of post-consumer material.

b) Level 2:

MM-4: The structural steel content must include 80% post-consumer recycled steel. Approximately 93% of structural steel is recycled. If Grade 350 Weldable Structural Steel can be produced from 80% post-consumer recycled steel, then this is acceptable. Either a steel mill or a steel fabricator should be consulted to ensure this is a viable option.

c) Level 3:

MM-4: Refer to *International Living Future Institute's Living Building Challenge*. Most structural steel is oftentimes produced from 100% recycled material. Rebar for concrete could be an exception due to its higher grade.

5. Use of Steel Rebar

a) Level 1:

MM-3: The steel rebar content must include 50% post-consumer recycled steel. 93% of structural steel is recycled and most structural steel contains a very high percentage of post-consumer content; however, a steel mill or steel fabricator should be consulted to confirm that Grade 400 Steel can be produced from predominately post-consumer (or recycled) steel. Because this is a higher grade, it might be more challenging.

b) Level 2:

MM-3: The structural steel content must include 75% post-consumer recycled steel. Approximately 93% of structural steel is recycled. If Grade 400 Steel rebar can be produced from 75% post-consumer recycled steel, then this is acceptable. Either a steel mill or a steel fabricator should be consulted to ensure this is a viable option.

c) Level 3:

Refer to *International Living Future Institute's Living Building Challenge*.

6. Sheet Steel Used for Decking

a) Level 1:

MM-4: The structural steel content must include 50% post-consumer recycled steel. Approximately 93% of structural steel is recycled and most structural steel contains some post-consumer content; however, a steel mill or steel fabricator should be consulted to



confirm that Grade 350 Weldable Steel can be produced from a large fraction of post-consumer material.

b) Level 2:

MM-4: The structural steel content must include 80% post-consumer recycled steel. Approximately 93% of structural steel is recycled. If Grade 350 Weldable Structural Steel can be produced from 80% post-consumer recycled steel, then this is acceptable. Either a steel mill or a steel fabricator should be consulted to ensure this is a viable option.

c) Level 3:

MM-4: Refer to *International Living Future Institute's Living Building Challenge*.



appendix C    **mechanical engineering feasibility review**



**Bold Engineering Inc.**  
2778 Dufferin Street, Suite 104,  
Toronto, ON M6B 3R7  
Canada

T: 416-556-0766  
F: 1-866-876-5758

**ENGINEERING FEASIBILITY REVIEW – MECHANICAL (FINAL)  
TEMPLATE DESIGN AND STANDARDS FOR NEW FIRE STATIONS  
2 TRUCK STATION – 1 STOREY OPTION**

**Prepared for:**

DPAI Architects  
1800-25 Main Street West, Hamilton, ON  
c/o: The City of Mississauga

Submission Date: October 27, 2020

**Prepared by:**

Bold Engineering Inc.  
2778 Dufferin Street, Suite 104  
Toronto, ON, M6B 3R7



## CONTENTS

1.0	EXECUTIVE SUMMARY.....	3
2.0	MECHANICAL.....	4
2.1	GENERAL.....	4
2.2	LEED / ENERGY CONSERVATION.....	4
2.3	CODES AND STANDARDS.....	5
2.4	OUTDOOR & INDOOR DESIGN CONDITIONS.....	5
2.5	HVAC.....	6
2.6	PLUMBING.....	9
2.7	FIRE PROTECTION.....	11
2.8	BUILDING CONTROLS.....	11
2.9	CITY OF MISSISSAUGA – CORPORATE GREEN BUILDING STANDARDS.....	11





## 1.0 EXECUTIVE SUMMARY

BOLD Engineering Inc. was retained by the DPAI Architects on behalf of The City of Mississauga to provide an Engineering Feasibility Study in order to aid in the design of proposed layouts for new fire stations proposed by DPAI Architects in order to meet the program requirements of the City of Mississauga Fire Department and associated stake holders. Our review will assess Structural, Mechanical and Electrical systems of the proposed layouts.

Our analysis is based on the program requirements outlined in the Template Design and Standards for New Fire Stations – Program Development Document developed by DPAI dated March 3, 2020. In addition to this document, our analysis will take into consideration, the latest building codes (OBC, ESA, TSSA, ASHRAE, etc.), City of Mississauga accessibility standards and City of Mississauga - Corporate Green Building Standards.

The proposed fire station layout for Option #1 is 2 Trucks, and 10 staff. During shift change, the facility shall accommodate 20 staff. Locker facilities shall accommodate 40 staff. On the “Hot Side” the facility includes laundry and work shop facilities, a bunker room, hose tower and utility spaces including: main electrical room, station storage, hot water room and janitors room. On the “Cold Side” the facility includes two (2) dorm rooms, fitness room, lockers and showers, washroom facilities, accessible (universal) washroom, computer work stations, two (2) captain’s rooms, kitchen and dining rooms, lounge, outdoor areas, IT rooms and janitor’s closet.

Detailed review of the Structural / Mechanical and Electrical Systems are detailed in the sections below.

Prepared by:

BOLD Engineering Inc.

A handwritten signature in black ink, appearing to read 'Manny Kahlon', is written over the printed name.

Per:  
Manny Kahlon, B.Eng.  
Mechanical Lead

## **2.0 MECHANICAL**

### **2.1 GENERAL**

1. This narrative design analysis shall be used in conjunction with the Architect's drawings and plans, and with Electrical and Structural design narratives to develop a complete synopsis of the mechanical design guidelines for end user stake holder approval for concept design.
2. The mechanical systems shall be designed and installed to provide adequate heating and cooling to all different parts of the fire station while maintaining the requirements of different air pressure levels between the Fire Fighter living areas "Cold Zone", and "Hot Zones" including truck bays and equipment storage areas. The plumbing design will be designed on-demand hot and cold water to all fixtures as well as separating the sanitary drainage from various parts of the fire station.
3. Final design documents shall be produced and signed by a licensed Professional Mechanical Engineer licensed for the Province of Ontario, retained by the City of Mississauga.
4. These Preliminary Mechanical Documents are not intended to reflect the complete requirements for construction documents. The final issued for construction detailed design drawings and specifications shall verify the project electrical requirements and determine the final electrical equipment sizes. The project design shall be in accordance with current applicable Codes, standards and ordinances of the Province of Ontario (OBC) and all related mechanical codes and standards.
5. Unless specifically noted, all elements needed to fulfill the requirements discussed in this narrative shall be designed, supplied, and installed by the issued for construction engineer of record.
6. The mechanical engineer of record shall be responsible for determining the design intent of the new Fire Hall. This narrative shall be used only as a basis for design in accordance with the program requirements put forth by DPAI, BOLD Engineering Inc. and the City of Mississauga.
7. All equipment selected will be energy efficient, compact, quiet and effective in the intended purposes. Equipment such as packaged rooftop unit that will be above 90% efficiency and fitted with economizer. All other fuel burning equipment such as hot water heaters, radiant tube heaters will of the highest efficiency available on the market currently. Refer of the Green standards in this section for more information.

### **2.2 LEED / ENERGY CONSERVATION**

1. This project shall not follow LEED design considerations but will adhere to the Green building standard requirements.

2. The building design, equipment, and systems to conform to, as a minimum, the mandatory provisions of the MNECB and ASHRAE 90.1.

### 2.3 CODES AND STANDARDS

1. Mechanical systems shall be in accordance with applicable codes and standards including, but not limited to:
  - a. Authorities Having Jurisdiction (local building department requirements, local fire department requirements, local by-laws).
  - b. City of Mississauga Energy Design Guideline
  - c. National Codes:
    - i. Air Conditioning and Refrigeration Institute (ARI)
    - ii. American National Standards Institute (ANSI)
    - iii. American Standard for Testing and Materials (ASTM)
    - iv. American Society of Mechanical Engineers (ASME)
    - v. NFPA-13
    - vi. Underwriters Laboratories of Canada (ULC)
    - vii. National Plumbing Code
    - viii. American Society of Heating Refrigeration and Air Conditioning Engineers (ASHRAE):
    - ix. Canadian/American Air Balance Council (CAABC)
    - x. Canadian Standards Association (CSA):
    - xi. CAN/CSA-B149.1-05, Natural Gas and Propane Installation Code.
    - xii. Sheet Metal and Air Conditioning Contractors National Association (SMACNA)
  - d. Ontario:
    - i. Ontario Building Code (OBC)
    - ii. Ontario Fire Code (OFC)
    - iii. Ontario Electrical Safety Code
    - iv. Operating Engineers Act
    - v. Ontario Ministry of Municipal Affairs and Housing (MMAH) - SB-10

### 2.4 OUTDOOR & INDOOR DESIGN CONDITIONS

1. The sizing of mechanical systems shall be based on the outdoor air conditions shown in the following table:

	<b>Dry Bulb Deg.C (Deg.F)</b> <b>Heating/Cooling</b>	<b>Wet Bulb Deg.C (Deg.F)</b>
OUTDOOR	-20 (-4.0) / 31 (87.8)	23 (73.4)
INDOOR		
General Living Area	22 (72) / 25(77)	
Sleeping Areas/Fitness	22 (72) / 22 (72)	
Truck Bays	20 (68) / NA	
Equipment Storage	20 (68) / NA	

2. Ventilation for acceptable indoor air quality shall conform to the following:
  - a. Ventilation to meet acceptable indoor air quality shall be in accordance with ASHRAE Standard 62 and the applicable building code.
  - b. Air handling units are to be complete with Economizers to make use of free cooling and ventilation during the shoulder seasons.
  - c. Humidification; General living/sleeping areas, fitness and kitchen areas are not typically provided with central humidification however spaces to adhere to ASHRAE standard. A humidification unit can be installed in mechanical rooms or in the ceiling plenums with the steam manifolds in the ductwork serving the living and sleeping quarters. The humidification level be controlled by a local thermostat.
  - d. Standard 55: Thermal Environmental Conditions for Human Occupancy.

## 2.5 HVAC

1. The fire station is a multipurpose building, which includes living areas, training, community education, equipment and vehicle storage, and hazardous material storage. The building is divided into Hot and Cold zones and is described as follows:
  - Hot Zone:
    - Apparatus and Maintenance Bay
    - Equipment Storage area
    - Laundry and Janitor Rm
  - Cold Zone:
    - Living/ Sleeping areas
    - Shower and Change Rooms
    - Offices
    - Kitchen
2. The HVAC system should be designed to prevent cross-contamination from hot area to cold area. Positive pressure is to be maintained in the Cold area to minimize contamination from Hot areas.
3. The HVAC system will consist of forced air heating and cooling system in the Living areas typically by a high-efficiency packaged rooftop gas heating, electric cooling unit. Consideration should also be given to a hybrid heat pump rooftop with supplementary gas-fired heater. Gas-fired infrared heaters in the Truck Bays.
4. All HVAC units will be of the highest efficiency available and all rooftop units are to be complete with economizers, enthalpy controller, 24-hour programmable thermostat, carbon dioxide (CO<sub>2</sub>) sensor.
5. Packaged rooftop units shall have Energy Recovery unit system with enthalpy wheel installed.



6. All ductwork terminating in perimeter wall or roof will be complete with external insulation 10 feet upstream of the roof/wall opening.
7. All HVAC equipment to within allowable noise criteria.
8. The HVAC system will be balanced by a certified air balancing contractor.
9. All equipment will have a startup test report for the contractor to fill in and submit for the engineer's review and will be included in the Operations and Maintenance (O&M) Manual.
10. Apparatus Bay:
  - a. Ventilation is typically supplied by the large truck bay door, and outdoor wall louvre connected to ductwork serving the truck bay. The outside air will be supplied without heat. The louvre dampers are interlocked with the general exhaust CO NOX removal system and the dedicated vehicle exhaust system. PCI is the preferred vendor for vehicle exhaust. The exhaust fans are to be located on the roof of the building to minimize noise.
  - b. General exhaust to be initiated by the CO or NOX sensors and to shut off when contaminant levels below that stipulated by code. General exhaust and interlocked outdoor air motorized damper to operate only when CO and/or NOX concentrations exceed preset levels. A manual pushbutton override is also to be provided to allow the system to operate for a preset time. The vehicle exhaust capture system is to be with a rail the full length of the bay and with pull-through capabilities.
  - c. Vehicle Exhaust; If the bay door opens the vehicle exhaust fan and the outside air dampers are to operate on a timed cycle. A manual pushbutton override is also to be provided to allow the system to operate for a preset time. New vehicle exhaust system installations to be compatible with fire department vehicle exhaust systems installed at other fire department facilities to allow exhaust tailpipe connection to any fire department vehicle.
  - d. Apparatus bay is to be under negative pressure relative to the rest of the facility.
  - e. Heating Source is to be gas-fired infrared heaters to run the length of the truck bay. Preferably one heater per truck bay. The combustion flue pipe is to terminate up through the roof.
  - f. Provide ceiling fans in cages for air circulation in the bay, fans are to be low velocity and volume.
11. Bunker Gear Room
  - a. The room is to be negative pressure and is to have an exhaust fan located on the roof. This room can be heated by a gas-fired heating unit, it should not be served a packed heating/cooling unit. Cooling is not required in this room. Provide door grilles or transfer air duct to allow air from adjacent areas.
  - b. Install two-speed exhaust fan on the roof, the fan will operate at high speed with wall mounted push button operator and will continue to run for 1 hour and then will slow down to low speed for all other times.



## 12. Laundry Room

- a. The laundry room will have a gas-fired heating only unit, and a transfer air ductwork to allow ventilation into the room. The clothes dryer unit will be connected to a booster fan interlocked to the operation of the dryer unit.

## 13. Support Spaces

- a. Support spaces such as a mechanical room, electrical room, storage room and janitor rooms will have heating and no cooling. The electrical room will have an exhaust fan with a reverse acting thermostat to engage when room temperature reaches 82 deg F. The janitor room will have an exhaust fan that exhaust to outside, the fan operation will be interlocked with a light switch, and fan will set to disengage 30 mins after lights off. There will be no mechanical services provided for the outdoor shed.

## 14. Cold Area (Living Area/ Office/ Kitchen/ Rec Rm)

- a. The Cold area will be served by a high-efficiency packaged rooftop unit with heating and cooling with consideration for hybrid heat pump rooftop unit with supplementary gas-fired heating. The rooftop unit is to have multi stage heating and cooling. The ductwork distribution from the rooftop unit will extend into the ceiling space of the area and flex ductwork to terminate at ceiling mounted diffusers. The return air is collected ceiling-mounted egg-crate grille and into the ceiling plenum. The return ductwork from the RTU's will extend approximately 10feet into the ceiling plenum where all return is to be collected.
- b. The rooftop unit system will be designed to provide more supply air than return air. Units dampers will be adjusted to create positive pressure within the Cold area to prevent contaminations from the Hot Areas.
- c. All supply and return will be acoustically insulated 10 feet downstream of the unit and all units are to be vibration isolation.
- d. The carbon dioxide sensor is to be installed in the return ductwork upstream of the RTU.
- e. The rooftop units are to be installed on roof curbs that are minimum 14" height, for a large unit where open structural frame support is required, provide a minimum 3 feet clearance from the top of roof level to the underside of the equipment.
- f. Do not locate rooftop units oversleeping quarter.
- g. A separate rooftop unit is to be provided for interior and perimeter zones. A variable air volume (VAV) and or by-pass box is recommended for each room. A VAV system is preferred since it allows for energy saving by reducing the fan RTU fan speed as well as improved temperature control. The entire perimeter space can be served by one RTU with VAV boxes for each room with its designated thermostat. The interior space can be served by the second RTU, and it also too has the option of a VAV system but is not necessary.
- h. Ceiling fans can be installed in the sleeping room for better air movement (caged for safety).

- i. In Sleeping room, install wall supply and return air grilles on wall to minimize ductwork runs, incorporate the Coanda effect to throw air across the room where possible.
- j. In the Kitchen, a hood will be installed over the range that will terminate out through perimeter wall or roof. The fan will be in the range of 200-300 CFM. There are no additional exhaust requirements. The supply air will be the central rooftop unit.
- k. The Gym room will be served by the perimeter RTU and will have a designated VAV box. In addition to this, it is recommended ceiling fans be installed for improved airflow as well as a 1.5-ton split system air condition unit with the condensing unit on the roof. The AC can be either wall-mounted or installed in the ceiling with supply ductwork.
- l. The IT Room will have a designated exhaust fan with a reverse acting thermostat and a 1 Ton split system air conditioning unit. The exhaust fan will be the primary unit to maintain space temperature and the AC as supplementary cooling. The exhaust from the IT room will be discharged into the ceiling plenum.
- m. All vestibules will have electric forced flow heater with designated thermostats, no cooling is to be provided.
- n. In the Locker room, supply air will be from the interior RTU, the exhaust will be a roof-mounted 2-speed exhaust fan. The exhaust will operate at high speed during the daytime and at low speed during the night. The fan will operate continuously for 24 hours.
- o. The washroom will only have a roof-mounted exhaust fan serving this area, each washroom stall will have an exhaust grille connected to the ductwork to the fan. Fan operation will be controlled by the occupancy light and the fan will be set to turn off 30 mins after the lights. Exhaust ductwork 10feet upstream of the roof opening will be thermally insulated.

## 2.6 PLUMBING

1. The incoming cold-water service will be 2" and will be brought into the mechanical room and connected to the water meter with backflow preventer assembly. The water meter will have a remote readout on the outside of the building provided by the local utility provider and installed by a mechanical contractor. Refer to green building standards section below for more information.
2. Sprinklered buildings will have a designated incoming fire protection line with its water meter and backflow preventer, this is will be determined by site services engineer. Combined domestic water and fire protection is not recommended as municipalities require incoming fire protection water to be metered complete with shut-off valves which is currently in contradiction to NFPA. Sprinklers shall be required only as determined by the architectural OBC matrix.
3. The leaving buried sanitary and storm drain service will connect to city street drain connection and will be coordinated with site services dwgs to match service location. Both storm and sanitary drain piping will be 6" diameter leaving the building.
4. All plumbing piping downstream of the water meter will be insulated and sized according to the flow rates.



5. Shut-off valves will be installed at each plumbing fixture and the hot water tank.
6. All plumbing piping will be labelled with direction arrows.
7. Apparatus Bay will be provided with 12” wide trench drains. The Bay drainage water will discharge into sediment and oil interceptors. Hot water will be provided by natural gas high-efficiency water heater/storage tanks with recirculation hot water pumps. A mixing valve shall be installed to control water temperature. The recirculation pump will be located in the mechanical room close to the hot water tank. The hot water combustion flue will terminate out through the perimeter wall.
8. All toilets are to be a wall-mounted, flush valve with an electronic (hard wired) flush.
9. All sanitary vent pipe up through the roof will be 3” diameter and will be installed over the washroom, janitor room, and mechanical room.
10. Non-freeze hose bibs will be installed on the building perimeter (locations to be determined on a project basis). The final locations shall be decided by the town. The recommended locations are in front of apparatus bay, back of apparatus bay, outside the facility part of the building (north side of the building) and office area (south side of the building).
11. For truck washing, high-efficiency hot water tank shall be used. Natural gas is used for the heaters.
12. All plumbing fixtures will be high-efficiency low flow, commercial grade. Coordinate with the owner for final fixture selections. Natural gas service will be connected to gas-fired equipment (water heater and tube heaters). The fire station building will be served with dedicated gas service.
13. Truck washing points, compressed air outlets and truck fill provisions shall be provided within the Bay area. One washing station is recommended for apparatus bay. Hot and cold water shall be connected to the wash station with a mixing valve. Compressed air connection shall be finalized by the fire station staff.
14. Eyewash station with mixing valve to be installed in the Apparatus Bay.
15. Bottle fill drinking fountain station installed in the Exercise Room and the Kitchen.
16. All roof drain locations will be determined by the architect and all roof drains are to control flow type. Piping from roof drains will be combined into multiple risers and connect at the buried level. All horizontal storm drain piping is to be insulated.
17. Dishwasher piping rough-in to be designed adjacent to the kitchen sink. Engineering to provide piping detail drawings.



18. A gas meter is located outside adjacent to the building facing the road. Gas piping enters the building and extends up through the roof. All gas piping is distributed at the roof level, and thru the roof to serve the infrared gas heaters.

## 2.7 FIRE PROTECTION

1. The building will be sprinkler as per NFPA13 and OBC. Location of sprinkler system assembly will be located in the mechanical incoming service room. Dry sprinklers shall be installed in areas where freezing is concern and also in the entrance vestibule.
2. All areas with T-bar ceiling and drywall ceiling will be fully recessed sprinkler heads, all areas without ceiling will have upright sprinkler heads.
3. All sprinkler heads are to be standard coverage for ordinary hazard classification.
4. Fire extinguishers will be installed in Kitchen, hallways, Apparatus Bay, and Mechanical/Electrical room. Fire extinguishers are to be Class ABC.

## 2.8 BUILDING & EQUIPMENT CONTROLS

1. A central building automation system (BAS) is not required.
2. Rooftop units will be controlled by a programmable thermostat.
3. Radiant gas-fired tube heaters and unit heaters will be controlled by programmable thermostats installed in local areas.
4. Exhaust fans will be controlled by 24-hour timer located in the mechanical room.
5. Hot water recirculation pump will have a integral controls with a digital screen for system manipulation.

## 2.9 CITY OF MISSISSAUGA – CORPORATE GREEN BUILDING STANDARDS

### 1. Energy and Climate Change

Fire Hall		
Level 1	Level 2	Level 3
EUI: 105 kWh/m <sup>2</sup> /year TEDI: 75 kWh/m <sup>2</sup> /year GHGI: 11 kgCO <sub>2</sub> e/m <sup>2</sup> /year	EUI: 80 kWh/m <sup>2</sup> /year TEDI: 60 kWh/m <sup>2</sup> /year GHGI: 5 kgCO <sub>2</sub> e/m <sup>2</sup> /year	EUI: 60 kWh/m <sup>2</sup> /year TEDI: 30 kWh/m <sup>2</sup> /year GHGI: 5 kgCO <sub>2</sub> e/m <sup>2</sup> /year

- a. Level 1 – Detailed mechanical energy usage calculations shall be performed during detailed design through energy modeling. To achieve the required Level 1 parameters above, the mechanical design shall incorporate the use of high efficiency gas-fired heaters and air conditioners and adherence with ASHRAE SB-10 and OBC energy requirements. In addition, energy recovery units with above 70% efficiency shall be specified for all ventilation related designs. Condensing domestic water heater or multiple instantaneous water heater should be considered. Standard SB-10 compliant HVAC and hot water heating equipment selection is also anticipated to help the overall



design in achieving the Level 1 requirements. The requirements of Level 1 is to exceed the SB-10 requirements by at least 35%. Provisions to achieve these requirements will not lead to significant higher equipment costs. A possible 10-15% increase in price as compared to the standard efficiency units.

- b. Level 2 – Even higher efficiency HVAC and hot water heating equipment alongside more sophisticated building automation controls are anticipated for helping to achieve Level 2 compliance. This may include energy recovery units (ERVs), domestic water and building drain piping heat recovery systems and solar energy electronic flush plumbing fixtures. Further coordination for mechanical HVAC control systems with electrical discipline is anticipated in order to control fan speed and ventilation requirements depending on occupancy. Provisions to achieve these requirements is anticipated to increase the mechanical budget by approximately 40-60%.
- c. Level 3 - This Level requires a reducing in overall energy usage of 45% over and above Level 1. A mechanical HVAC system consisting of geothermal heating and cooling and centralized exhaust system and ventilation system by means of a custom make-up air with an ERVs may be required to achieve this level as well as hybrid heat pump rooftop units.

Geothermal wells beneath the ground take advantage of the earth's stable temperatures. Water with glycol mixture is circulated through pipes extending into the ground to extract or discharge heat to efficiently warm and cool the building.

A high-efficiency ERV system captures and reuses 75% of the exhaust heat that would otherwise be lost from the building. This along with the highest efficiency heat pumps on the market, and gas fired equipment for supplementary heat and domestic hot water heating will help contribute to a level 3 compliant design.

Consideration for a hybrid heat pump packaged rooftop unit with supplementary gas-fired heating and fully modulating compressor to provide exact heating and cooling with highest efficiency. The supply fan and condenser fan should both be with electronically commutated motor (ECM) also known as VFD motors. Where possible, RTU should also incorporate a packaged ERV add on.

A hydronic water heating system installed on the roof can be used to preheat domestic water along with high efficiency boilers complete with ECM motor pumps will help add solar heating to the DHW system.

Using multiple units for improved zoning and temperature control will lead more energy efficiency.

Provisions listed here to achieve these requirements is anticipated to increase the mechanical budget by approximately 150%.

*Please note that on-site renewables may also be required to achieve the parameters above and will be discussed in sections below. The cost provisions in this section do not take into account on-site renewables which have been separately costed (high level) below.*

## 2. Building Commissioning

Monitoring-based Commissioning: Develop monitoring-based procedures and identify points to be measured and evaluated to assess performance of the major energy-consuming systems representing more than 10% of the building's total energy use (at a minimum heating, cooling, lighting, fans, and pumps).

- a. Level 1 – This level of commissioning requires Monitoring-based Commissioning including but not limited to:
  - i. Commissioning Plan
  - ii. Commissioning Report
  - iii. Current Facilities Requirements and Operations and Maintenance Plan

Mechanical equipment and related systems that will be included in the commissioning plan includes but is not limited to:

- i. Hot water heaters (gas fired & Solar)
- ii. Plumbing fixtures
- iii. Energy recovery units (air and water)
- iv. Air handling units (heat pumps, packaged RTU's, fans)
- v. Geothermal loop
- vi. Building automation System (BAS)
- vii. Pumps

Level 1 commissioning will add a 15% cost to the overall mechanical budget compared with a package where no documented commissioning is required.

- b. Level 2 – This level includes all requirements of level 1 with the addition of the following:
  - i. System operational manual.
 Level 2 commissioning cost increase as it relates to Level 1 will be 20-30% higher.
- c. Level 3 – As it relates to mechanical systems this level is not applicable.

## 3. On-Site Renewables

On-site energy generation using renewable energy sources is encouraged to reduce GHG emissions associated with building operation, as well as to reduce stresses imposed on the local electricity grid and further improve building resilience in the wake of power outages.

- a. Level 1 – Domestic hot water hydronic heating systems can help achieve level 1 compliance. It shall be noted that typically these systems are located on roof spaces. Depending on renewable goals, a cost benefit analysis will be required to determine the

most efficient use of roof space for achieving the renewable goals. Evaluating, Hydronic heating vs. Solar PV electrical generation in order to determine the best use of budgets, roof space etc. will determine which system (or perhaps a combination of both) can be implemented. A Solar Hydronic heating system will add 15% - 25% to the mechanical budget.

- b. Level 2 – For level 2, a geothermal system shall be considered. Geothermal wells beneath the ground take advantage of the earth’s stable temperatures. Water with glycol mixture is circulated through pipes extending into the ground to extract or discharge heat to efficiently warm and cool the building. The cost of this system is anticipated to add a 50% increase to the entire mechanical budget.
- c. Level 3 – This level is not possible with a mechanical renewable system. There is the option of adding solar panels to the rooftop units to reduce the energy cost. The unit’s solar energy is first used to meeting the cooling/heating demand, when the cooling system is not operating, the system powers lighting, appliances and other electronic devices. The solar system is not capable of providing the fully power needed during peak demand and thus will need power connection to the building. Currently, there is nothing available in the market to completely make the mechanical system external energy independent.

#### **4. Air Tightness**

This category is not part of the mechanical design but does impact the mechanical HVAC system design. Air tight buildings will reduce the energy lost and therefore smaller equipment can be used to heat and cool the building. A good building envelope design will actually save mechanical costs and reduce overall mechanical equipment energy usage.

#### **5. Metering and Benchmarking**

The intent of this measure is to ensure that buildings are provided with an adequate level of metering and measurement systems to facilitate ongoing tracking of energy usage by the building systems.

- a. Level 1
  - i. Metering - Install electricity and / or thermal sub-meters for all energy end-uses that represent more than 10% of the building's total energy consumption. This shall include lighting panels, large HVAC equipment, large gas loads such as hot water tanks, infra-red tube heaters, etc. Provision of electricity and thermal sub-meters shall be clearly indicated on electrical single-line diagrams. A metering plan listing all meters along with type, energy source metered, diagrams, and/or references to design documentation shall be provided.
  - ii. Benchmarking - Register the building on ENERGY STAR Portfolio Manager and co-ordinate with the City of Mississauga Energy Management Team to establish the process for ongoing reporting and benchmarking.

- iii. There will be a 2-3% increase to the mechanical construction cost and approximately additional 5-10% for building automation integration.
- b. Level 2 – Same as Level 1
- c. Level 3 – Same as Level 1

## 6. Resilience Performance Requirements

The intent of this measure is to promote buildings that are designed to maintain critical operations and functions in the face of a shock or stress, and quickly return to normal operations to maintain healthy, livable spaces for its occupants.

- a. Level 1 - Not applicable to mechanical (refer to electrical).
- b. Level 2 - Not applicable to mechanical (refer to electrical)
- c. Level 3 – Not applicable to mechanical (refer to electrical)

## 7. Low-impact Materials

Not applicable for Mechanical.

## 8. Embodied Carbon Footprint

Not applicable for Mechanical.

## 9. Ozone Depleting Compounds

Mechanical air conditioning units are release harmful HCFC' from the refrigeration liquid. HVAC coolants naturally deplete over time by leaks in piping and fittings.

- a. Level 1 – Calculate and report HVAC & R equipment emission associated with the air handling units installed. All equipment using refrigerants in its process to provide air conditioning must comply with equation  $LCGWP + LCODP * 10^5$  must be less or equal to the number 13.
- b. Level 2 – Calculate and report carbon footprint as calculated in step 1 and to reduce to completely eliminate the HCFC and Halon emissions.
- c. Level 3 – Not feasible for this project, as this option requires zero level of refrigerant and the use of evaporative cooling. Evaporative cooling is not likely option for areas with high humidity in the summer such as the greater Toronto area.

## 10. Electric Vehicle Infrastructure



Not applicable for Mechanical.

#### 11. Bicycle Infrastructure

Not applicable for Mechanical.

#### 12. Waste Management Performance Requirements

Not applicable for Mechanical.

#### 13. Stormwater Management

The intent of this measure is to manage and reduce the stormwater discharge from the site to city sewer system by controlling roof drains flow and by absorbing the water on the site soil.

- a. Level 1 – Installing control flow roof drains to collect water on the roof of building and installing scupper drain for any overflow that will flow onto grade. Introduce gray water system by collecting rain water in storage tanks above ground for irrigation use. Provisions to achieve these requirements is negligible to the total mechanical budget. The structural load on the roof will have to be reviewed by the structural discipline.
- b. Level 2 – Design a water storage cistern that is designed to store a once in 100-year rainfall. The tank will be stored below grade and away from vehicle traffic. The system will require space to install the pumps and irrigation system and other non-potable water use services. The storage system will be designed with the option to bypass and discharge directly into city's street storm lines. This option will add at least 20% to the mechanical and civil budgets.
- c. Level 3 – In addition to the above, a green roof system designed by architect and structural engineer may require drainage system. Mechanical scope of work is dependent on the type of green roof. Allow a 10% adder to the mechanical plumbing and drainage budget.

#### 14. Water Use Intensity

The intent of this measure is to reduce potable water usage by selecting highly water efficient fixtures. Rainwater collection systems collect water for landscape irrigation and other uses that don't require significant treatment. If the collection vessels are on or under the ground, they don't pose a problem. Gray water is typically recognized as a source of potentially recycled water that has been used but not polluted. This normally comes from bathing, washing, and similar activities. Gray water can be collected and reused for landscape irrigation and other uses that don't require potable water.

- a. Level 1 – Install high efficiency toilets, urinals, faucets, and shower heads. Install aerators on faucets heads to further reduce water discharge. The water closet (toilet) flow rates can start from 1.28 gallons per flush (gpf) and down to 0.8 gpf. The show flow



rates to 1.75 gpm @ 80 psi of pressure, and sink faucets down to 1.5 gpm. Installing electronic no touch faucets and timers on showers help to reduce water usage. Cost of installing water saving fixtures is approximately 1-2% of total mechanical budget.

- b. Level 2 – Use gray water for all irrigation demand. Rainwater from roof drains can be collected into a storm water reservoir. The incoming water into the tank will be strained and filtered. The water can then be pumped for reuse. The tank can be buried similar to a septic tank at landscaped area near the building. The drawback to using gray water for all outdoor potable services is that supply may not always satisfy the demand. The cost addition is estimated to be between 5-10% of the mechanical budget.
- c. Level 3 – Using gray water to flush toilets and urinals will help achieve level 3. This measure requires the installation of a separate water supply piping system from the cistern to the fixtures. There is added cost of pump installation and operation to push the water from tank to the fixtures. The additional cost associated with this option is approximately 10-15% of the mechanical cost.

15. Erosion and Sediment Control

Not applicable for Mechanical.

16. Light Pollution

Not applicable for Mechanical.

17. Biodiversity

Not applicable for Mechanical.

appendix D **electrical engineering feasibility review**





**Bold Engineering Inc.**  
2778 Dufferin Street, Suite 104,  
Toronto, ON M6B 3R7  
Canada

T: 416-556-0766  
F: 1-866-876-5758

**ENGINEERING FEASIBILITY REVIEW – ELECTRICAL (FINAL)**  
**TEMPLATE DESIGN AND STANDARDS FOR NEW FIRE STATIONS**  
**2 TRUCK STATION – 1 STOREY OPTION**

**Prepared for:**

DPAI Architects  
1800-25 Main Street West, Hamilton, ON  
c/o: The City of Mississauga

Submission Date: October 27, 2020

**Prepared by:**

Bold Engineering Inc.  
2778 Dufferin Street, Suite 104  
Toronto, ON, M6B 3R7



## CONTENTS

1.0	EXECUTIVE SUMMARY.....	3
2.0	ELECTRICAL.....	4
2.1	GENERAL.....	4
2.2	SITE ELECTRICAL SERVICES - POWER.....	4
2.3	SITE ELECTRICAL SERVICES - LIGHTING.....	5
2.4	SITE ELECTRICAL SERVICES - COMMUNICATIONS.....	5
2.5	BUILDING ELECTRICAL - POWER.....	6
2.6	BUILDING ELECTRICAL – POWER (EMERGENCY).....	7
2.7	BUILDING ELECTRICAL – LIGHTING.....	8
2.8	BUILDING ELECTRICAL – COMMUNICATIONS.....	9
2.9	BUILDING ELECTRICAL – FIRE ALARM AND LIFE SAFETY.....	10
2.10	SECURITY AND ACCESS CONTROL.....	11
2.11	GENERAL ELECTRICAL.....	12
2.12	CITY OF MISSISSAUGA – CORPORATE GREEN BUILDING STANDARDS.....	14



## 1.0 EXECUTIVE SUMMARY

BOLD Engineering Inc. was retained by the DPAI Architects on behalf of The City of Mississauga to provide an Engineering Feasibility Study in order to aid in the design of proposed layouts for new fire stations proposed by DPAI Architects in order to meet the program requirements of the City of Mississauga Fire Department and associated stake holders. Our review will assess Structural, Mechanical and Electrical systems of the proposed layouts.

Our analysis is based on the program requirements outlined in the Template Design and Standards for New Fire Stations – Program Development Document developed by DPAI dated March 3, 2020. In addition to this document, our analysis will take into consideration, the latest building codes (OBC, ESA, TSSA, ASHRAE, etc.), City of Mississauga accessibility standards and City of Mississauga - Corporate Green Building Standards.

The proposed fire station layout for Option #1 is 2 Trucks, and 10 staff. During shift change, the facility shall accommodate 20 staff. Locker facilities shall accommodate 40 staff. On the “Hot Side” the facility includes laundry and work shop facilities, a bunker room, hose tower and utility spaces including: main electrical room, station storage, hot water room and janitors room. On the “Cold Side” the facility includes two (2) dorm rooms, fitness room, lockers and showers, washroom facilities, accessible (universal) washroom, computer work stations, two (2) captain’s rooms, kitchen and dining rooms, lounge, outdoor areas, IT rooms and janitor’s closet.

Detailed review of the Structural / Mechanical and Electrical Systems are detailed in the sections below.

Prepared by:

BOLD Engineering Inc.

Per: 

Chris Politis, P.Eng.

Principal / Project Manager

## **2.0 ELECTRICAL**

### **2.1 GENERAL**

1. This narrative design analysis shall be used in conjunction with the Architect's drawings and plans, and with Mechanical and Structural design narratives to develop a complete synopsis of the electrical design guidelines for end user stake holder approval for concept design.
2. Final design documents shall be produced and signed by a licensed Professional Electrical Engineer licensed for the Province of Ontario, retained by the City of Mississauga.
3. These Preliminary Electrical Documents are not intended to reflect the complete requirements for construction documents. The final issued for construction detailed design drawings and specifications shall verify the project electrical requirements and determine the final electrical equipment sizes. The project design shall be in accordance with current applicable Codes, standards and ordinances of the Province of Ontario (OBC) and the Ontario Electrical Safety Code (OESC).
4. Unless specifically noted, all elements needed to fulfill the requirements discussed in this narrative shall be designed, supplied, and installed by the issued for construction engineer of record.
5. The electrical engineering of record shall be responsible for determining the design intent of the new Fire Hall. This narrative shall be used only as a basis for design in accordance with the program requirements put forth by DPAI, BOLD Engineering Inc. and the City of Mississauga.

### **2.2 SITE ELECTRICAL SERVICES - POWER**

1. Coordinate with Local Utility, including service application for building.
2. Provide concrete pad / grounding for Local Utility pad mounted transformer as required by local utility standards. If a pad mount transformer is required, the exact location shall be coordinated on site with the local utility, City of Mississauga Planning Department and Engineer of Record as part of the Site Plan Approval (SPA) process.
3. Provide duct bank and feeders from the pad mounted transformer / pole mounted transformer to the main disconnect, in the proposed electrical room ideally located within the Apparatus Bay as close as possible to the building perimeter and as close as possible to the utility transformer location. Coordinate exact requirements with Local Utility.
4. Provide the Main Disconnect and Customer Metering Cabinet and Meter as per Local Utility standards.
5. A facility grounding system shall be provided in order to establish a low impedance

ground path for equipment grounding. The grounding system shall include connections from the main switchboard to an under ground, cold water pipe, and building steel. Supplement the grounding system with a ground rod placed near the main switchboard. All grounding electrode connections shall be by irreversible exothermic welds.

6. Provide a ground bond per Ontario Electrical Safety Code (OESC) requirements to all metallic systems which may become energized (gas piping, fire sprinkler piping and the like). Provide ground bars in each Server Room backboard and Main Telecommunications Terminal Backboard (MTTB) connected to the main disconnect ground terminal.

### **2.3 SITE ELECTRICAL SERVICES - LIGHTING**

1. The goals of the site lighting shall include the following:
  - a. Provide a safe and secure environment;
  - b. Minimize environmental concerns (light trespass) of the neighborhood and the community in general; the foot-candle level shall be no greater than 0.1 foot-candles at the property line.
  - c. All exterior lighting shall be zero cut off.
  - d. All exterior lighting shall be dark sky compliant
  - e. Provide light of sufficient quantity and quality for security cameras (as required);
  - f. Draw visitors to the entries;
  - g. Provide sufficient light while keeping a low visual profile to the community;
  - h. A system which is maintainable;
  - i. Low energy consumption through the use of efficient sources.
2. All exterior lighting sources shall be Light Emitting Diode (LED).
3. Provide building mounted lighting utilizing vandal resistant type luminaires for exterior egress lighting and general lighting at walkways surrounding the buildings. Building entries shall have a minimum of 5 foot-candles. Exterior walkways shall have an average maintained light level of 1 foot-candle with a minimum of .25 foot-candles.
4. Exterior lighting shall be provided with time-based switching relay lighting control panel for control of the exterior area lighting. Provide a 2-hour by-pass wall switch adjacent to the lighting control panel for use in maintaining exterior luminaires.
5. Final design shall provide adequate coverage for service receptacles recessed mounted on pole mounted pole lights. This shall be determined during the detailed design stage by the electrical consultant.

### **2.4 SITE ELECTRICAL SERVICES - COMMUNICATIONS**

1. Coordinate with local telecommunications utility companies for new underground services to building. Provide all trenching, boxes and raceways as required.
2. Demarcation location shall be the IT room.

3. Provide 2 hour fire rated back board in IT room for Communication Utility termination.
4. Provide controller for exterior pylon sign.

## **2.5 BUILDING ELECTRICAL - POWER**

1. Detailed design package shall include a complete single line diagram with equipment and feeder sizing, panel schedules, and a project load summary.
2. The final detailed design package shall include site distribution layout and electrical room layouts.
3. The final detailed design package shall be submitted by the Engineer of Record to the Electrical Safety Authority (ESA) for Plan Review.
4. The final design package shall include a short circuit / coordination study and arc flash analysis.
5. The main electrical service and main Disconnect are estimated to be rated at 400A, 120/208V, 3 phase, 4 wire.
6. The facility shall be providing with an emergency full backup natural gas generator on site external to the building footprint that meets the total power required of the full facility complete with an automatic transfer switch.
7. Provide separate panel boards for Receptacle, Lighting, and Mechanical loads. Surface or Recessed mounted in proposed electrical room. Provisions shall be made for load monitoring and metering of large loads in accordance with the City of Mississauga Green Design Standards. Refer to section 2.12 of this report for further detail.
8. Power conductors will be stranded, copper, type THHN/THWN insulation, rated for 600V. No aluminum wires or cables shall be allowed. All conductors will be routed in a wire way, or conduit. Flexible conduit shall be used for equipment connections. Electrical metallic tubing (EMT) shall be used for concealed lighting and receptacle branch circuits. Wherever possible, conduit will be concealed within construction. Conduits shall not be allowed to be placed in concrete slabs or decks. Where conduit is exposed below 8-feet, galvanized rigid steel conduit (GRC) or intermediate metal tubing (IMT) will be used. Use of Metal Clad (MC) cable is prohibited. Flexible Metallic Conduit (FMC) conduit will be allowed for minimal use where construction methods dictate the need. Steel insulated compression type conduit fittings shall be used. Polyvinyl chloride (PVC) conduit shall be used underground with GRC conduit for sweeps and risers. Corrosion resistant tape wrap will be applied to underground GRC.
9. The branch panels shall serve necessary wiring devices for equipment and convenience power. Branch circuits shall be run in metallic conduit (PVC where routed below grade). The amperage, voltage, NEMA configuration of the wiring devices (receptacles) shall be as



required by the equipment nameplate / cord set. 120V duplex receptacles shall be 15A minimum, specification grade.

10. Power connections to systems furniture shall be hard-wired, coordinate points of connection with furniture installer. (If any).
11. Provide power feeder to mechanical and plumbing equipment as required. Include safety disconnects at each piece of equipment. Provide receptacles within 25 feet of mechanical equipment; at exterior locations provide weather resistant receptacles with ground fault interrupter and while-in-use weather proof covers.
12. Receptacles will be provided in all areas as required by the stake holders. All wiring devices shall be specification grade. Workstations shall be provided with multiple receptacles served from general use panel boards. Provide dedicated neutral conductors with receptacle branch circuits.
13. Provide miscellaneous power circuits and connections to A/V equipment, phone / data equipment racks, mechanical control panels and the like. The detailed design shall coordinate project needs in each space with the Owners and end users and (at minimum) provide the following:
  - a. General convenience outlets connected with no more than (4) to a 15A branch circuit.
  - b. Dedicated receptacles/branch circuits where needed. (i.e. printers, copiers, shredders, office equipment, appliances, equipment, etc.)
  - c. Coordination with low voltage systems contractors / vendors and dedicated circuits / connections to equipment panels. (i.e. Security, Energy Management System, etc.)
  - d. Coordination with Owner's Information Technology (IT) representative for dedicated circuits/receptacles for data racks, grounding, etc.
14. Detailed design shall include provisions for feeder and automatic transfer switch as required to suit owner's emergency generator requirements.
15. Provide Electrical Power Distribution System per OESC standards.
  - a. Voltage Drop, Feeder conductors shall be sized for a maximum voltage drop of 2 percent at design load. Branch circuit conductors shall be sized for a maximum voltage drop of 3 percent at design load.
16. Provide ceiling suspended retractable cord reel in apparatus bays located in non-drive lane locations, mounted to structural ceiling framing. Cord reels shall be quick disconnect type with minimum 45' cord length.

## 2.6 BUILDING ELECTRICAL – POWER (EMERGENCY)

1. The entire facility requires emergency backup power. A Kohler / Sommers / Generac or equivalent full back up onsite outdoor natural gas generator shall be installed in a suitable outdoor location on the property external to the building footprint to be coordinated as part of the Site Plan Approval Process.

2. The generator shall be mechanically protected by bollards and / or concrete curbs.
3. The natural gas supply shall be monitored by the generator's alarm system and / or fire alarm system as determined required during the detailed design stage. The alarm output shall be coordinated with project stake holders.
4. The generator's capacity is estimated to be 100KW, 120/208V, 3PH, 4W.
5. The generator enclosure shall be a weather proof sound attenuated enclosure. The sound attenuation rating shall be in line with site specific requirements such as proximity to neighboring properties and property types. If required detailed design analysis shall include a noise study to determine required sound attenuation.
6. The emergency generator secondary feed shall be installed below grade, via underground duct banks into the electrical room ideally located within the Apparatus Bay as close as possible to the building perimeter and as close as possible to the utility transformer location. The feed shall terminate at the emergency supply of the Automatic Transfer Switch (ATS).
7. The ATS will automatically detect a utility power failure and switch on the generator, transferring electrical load to the emergency service within 10-20 seconds.
8. The generator's fuel supply shall be natural gas. *As we are recommending a natural gas generator, we do not need to consider fuel supply capacity.*
9. Ontario is considered as a reliable natural gas service jurisdiction for life safety and non-life safety emergency loads, meaning only a catastrophic interruption in natural gas service distribution system will affect the generator fuel supply.
10. *At this time, we do not recommend specifying a life safety rated generator, as there are few actual life safety loads within the facility. Only emergency lighting loads are required to be life safety rated and so for the cost of a few battery packs, there can be significant savings in power distribution costs by rating the generator as a simple non-life safety backup generator and installing a few emergency lighting battery packs.*

## 2.7 BUILDING ELECTRICAL – LIGHTING

1. All interior lighting sources shall be Light Emitting Diode (LED).
2. Personal Offices, Open Offices, Conferences, Kitchen, Data and Training Rooms shall be designed for average maintained light level of 50-55 foot-candles.
3. The apparatus bay shall be designed for average maintained light level of 80-100 foot-candles.



4. Ancillary spaces, such as Janitor's Rooms, Electrical and Mechanical Rooms, Lobbies and general Storage area shall be designed for average maintained light level of 35-40 foot-candles.
5. Restrooms shall be designed for average maintained light level of 35-40 foot-candles.
6. Egress lighting shall be provided throughout the facility by means of unit equipment. (i.e. 120-minute battery packs integrated into the facility luminaires and exit signs with battery back-up). The design shall provide the minimum egress light levels per OBC along the entire egress path of travel. Provide exterior egress lighting at egress points (exits) and where there is a change in grade. Basis of design: Exit Signs shall be Bagheli, Stanpro or approved equivalent.
7. Lighting control shall include but not be limited to the following:
  - a. Dual tech occupancy sensors with manual on and automatic off in:
    - i. Private Offices.
    - ii. Sleeping Areas – Automatic off only (No Auto on function)
    - iii. Fitness Studio
    - iv. Lounge Areas – Automatic off only (No Auto on function)
    - v. Utility Spaces
  - b. Manual light switch control in:
    - i. Kitchen Areas
    - ii. Apparatus Bays
    - iii. Corridors
  - c. Day light sensing and automatic dimming during day light hours of selected fixtures to save on energy.
  - d. Lighting in all dorm room shall be linked to the fire fighter call system and complete with gradual dimming system.
  - e. Dimming shall be designed for the following areas:
    - i. Dorm / Sleeping Areas
    - ii. Lounge
8. Primary lighting fixtures being utilized shall be 1'x4', 2'x2' and 2'x4' LED troffers, and High Bay LED Fixtures (to be determined during detailed design).
9. All fixtures shall maintain a consistent lighting temperature of 3500K.
10. All fixtures shall have a CRI rating of 90.
11. All lighting control design shall conform to ASHRAE – Chapter 9.

## **2.8 BUILDING ELECTRICAL – COMMUNICATIONS**

1. All UTP Category 6 cabling shall be installed in accordance with ANSI/TIA/EIA 568C requirements. System shall be supplied by one manufacturer end-to-end, to ensure clarity in troubleshooting and compatibility of all components.

2. Route all cables to maintain minimum separation from sources of interference such as lighting, power cables, HVAC and other electrical equipment. Avoid cross-overs and congestion.
3. All data, voice and AV cables shall be pulled in continuous runs; no in-line splices are allowed.
4. Installer shall be certified by the manufacturer to install, test, and warrant the system, and shall provide certification documentation at closeout.
5. Supports: Provide cable supports, harnesses, and sleeves as required. All free running cables shall be securely fastened to appropriate cable supports and harnesses with maximal inter-support cable sag of 150mm. all cables shall be completely supported by the harnesses so that no weight is transferred to any other existing fixture or ceiling space structure. Cable supports shall be caddy cablecat or equivalent.
6. Labeling: Each horizontal cable and patch cord shall be affixed with mechanically printed labelling tabs or typed letter self-adhesive mylar at both ends. (The lettering shall not be exposed). Each cable and termination jack shall be labelled with a mechanically printed identification label. Cable labels to be self-laminating vinyl construction with white mark-on colour and clear overlaps. Cable label shall be a minimum of 2” (50mm) wide and of sufficient length to permit clear overlap to be wrapped completely around cable at least one and a half times.
7. Labeling Scheme: Data cables: D.X-1 to 100; Voice cables: V.X-1 to 100, where letters and numbers denote: ‘D’ - data cable, ‘V’ - voice cable, ‘X’ - floor number, next number denotes cable number.

## **2.9 BUILDING ELECTRICAL – FIRE ALARM AND LIFE SAFETY**

1. Where required by OBC Architectural Matrix, detailed design shall include a complete fire alarm riser diagram showing fire alarm devices and annunciator panel zoning schedule.
2. The fire alarm system design shall be submitted as part of the building permit application. These documents shall be produced and signed by a licensed Professional Electrical Engineer licensed for the Province of Ontario.
3. The equipment and installation shall comply with the current provisions of the following standards and codes:
  - a. Underwriters Laboratories Inc. Standards:
    - i. ULC shall list the system and all components for use in fire protective signaling systems. The ULC label shall be considered as evidence of compliance with this requirement. the equipment shall be listed by ULC under the following standards as applicable:
    - ii. CAN/ULC-S527 Control Units for Fire Alarm Systems

- iii. CAN/ULC-S529 Smoke Detectors for Fire Alarm Systems
  - iv. CAN/ULC-S530 Heat Detectors for Fire Alarm Systems
  - v. CAN/ULC-S525 Audible Signal Appliances for Fire Alarm Systems
  - vi. CAN/ULC-S528 Manual Pull Stations for Fire Alarm Systems.
  - vii. CAN/ULC-S548 Alarm Initiating and Supervisory Devices for Water Type Extinguishing Systems
  - viii. CAN/ULC-S536 Inspection and Testing of Fire Alarm Systems.
  - ix. CAN/ULC-S524 Installation of Fire Alarm Systems
  - x. CAN/ULC-S537 Verification of Fire Alarm Systems
4. All control panel assemblies and the connected automatic and manual alarm and notification appliances shall be designed and manufactured by the same company; shall be tested and cross-listed as to ensure that a fully functioning life safety system is designed and provided.
  5. The fire alarm/life safety system supplied under this specification shall be a microprocessor-based, addressable fire alarm / life safety system.
  6. All fire alarm equipment shall be arranged and programmed to provide a system for the early detection of fire, the notification of building occupants, the automatic summoning of the local fire department, the activation of other auxiliary systems to inhibit the spread of smoke and fire, and to facilitate the safe evacuation of building occupants.
  7. A standby power supply shall automatically provide electrical energy to the system upon primary power supply failure. Standby power supply shall be an electrical battery with capacity to operate the system under maximum supervisory load for 24 hours, and capable of operating the system for 30 minutes in the alarm mode at 100% load. fire alarm system shall include a charging circuit to automatically maintain the electrical charge of the battery.
  8. All equipment furnished for this project shall be new and unused. All equipment, materials, accessories, devices, and other facilities covered by this specification shall be the best suited for the intended use and shall be the product of a single manufacturer.
  9. In cases where a maglock is required, the Engineer of Record shall be responsible for notifying their engineer of record for submission for building permit.

## **2.10 SECURITY AND ACCESS CONTROL**

1. All security and access control systems shall be designed and installed in accordance with the City of Mississauga Corporate Security Standards.
2. A CCTV security camera system shall be installed to monitor the exterior perimeter of the facility. This CCTV system shall be networked with the City of Mississauga Corporate Security Office. Recording and record storage parameters shall be determined during detailed design and in consultation with facility stake holders.

3. Additionally, CCTV cameras shall be installed on the exterior of the building covering the parking lot.
4. A dedicated security camera shall be installed in the main entrance vestibule with feed to the Captains office.
5. Intrusion system is to be installed within the facility with the following standards:
  - a. All doors leading to the exterior installed with door contact,
  - b. All areas with window access to have glass break with motion sensors.
  - c. Long range motions are to be installed in the truck bay.
  - d. Pin pad to be installed beside the overhead bay door upon exit to arm and disarm the facility.
6. Card readers shall be installed on the following doors:
  - a. Main entrance vestibule (interior door).
  - b. Rear entrance personnel door(s).
  - c. Front overhead doors (all)
  - d. Rear overhead doors (all).
  - e. Any interior doors requiring special access (TBD during detailed design).
7. Door Contacts shall be installed on all doors where card readers are installed. Door contactors shall monitor door status of these doors.
8. Piezo (audible) alarms shall be installed on all man doors such that they will sound when a door has been left opened for a preset amount of time. This shall be monitored by the door access control system.
9. Electrical strikes shall be preferred to Maglocks where possible. Either electric strikes or maglocks shall be installed on doors requiring card readers.

## 2.11 GENERAL ELECTRICAL

1. The electrical design shall meet all applicable Codes.
2. Lighting design shall meet the recommendations of the current edition of Illumination Engineering Society of North America (IESNA). The design team shall be responsible for producing point-by-point photometrics to justify the final lighting layouts to meet the Owner's needs.
3. Exterior Luminaires shall meet IESNA "cut-off" definition.
4. The electrical installation shall be tested by an independent testing agency as approved by the City of Mississauga (as required). Testing shall include but not be limited to: the grounding system, testing and coordination of main overcurrent protection devices, feeders greater than 200 amperes, emergency systems (egress lighting) and UPS systems, etc.

5. Final installation shall be certified by ESA. A copy of all ESA certificates shall be provided to the City for record.
6. The emergency lighting installation shall be tested by an independent testing agency as approved by the City (as required). Testing shall be completed to ensure the operation and minimum run time is met according to the design intent and OBC.
7. The data and cabling installation shall be tested by an independent testing agency as approved by the City (as required). Provide test reports for both data and voice cabling. UTP Cat 6 testing shall include: attenuation; near-end crosstalk (next); insertion loss; power sum next (PS-NEXT); return loss (RL); equal level far end crosstalk (ELFEXT); power sum elfext (PS-ELFEXT); far end crosstalk (FEXT); attenuation to crosstalk ratio (ACR); power sum attenuation to crosstalk ratio (PSACR).
8. Electrical distribution equipment shall be from Eaton, Cutler Hammer, Schneider or approved equivalent product line for switchboard, transformers, panel boards, and disconnect switches and the like.
9. Occupancy sensors shall be designed based upon Lutron, Crestron and Acuity Products or approved equivalent. Coordinate sensor placement with manufacturer's recommendations.
10. Wiring devices shall be designed based upon standard City of Mississauga preferred product standards where available.
11. Data cabling and communication devices shall be designed based upon Panduit, Belden and Commscope products or approved equivalent.
12. Fire alarm equipment shall be from Chubb Edwards, Notifier, Mircom or approved equivalent product line for fire alarm minihorns / speakers, manual pull stations, smoke alarms, heat detectors and the like.
13. The fire alarm installation shall be tested by an independent testing agency as approved by the City (as required). Provide a fire alarm verification report to the Owner for their review and record.
14. Coordinate with Communication Designer for conduit requirements between Main Telecommunications Terminal Backboard "MTTB" in the Electrical room and Server Room.
15. Coordinate all communication requirements with the City for any specialty equipment requirements in regards to server, UPS, patch panels, server cabinets, backboards and the like.
16. Coordinate all Video and Audio requirements with the Town for all HDMI, Data and specialty outlets required.

17. Coordinate with all disciplines, (i.e., Plumbing, Mechanical, Landscape, Civil, etc.) for connection to all equipment requiring power.
18. Coordinate with Security Consultant for conduit requirements for all security device rough-ins.
19. Provide rough-ins for break in detection on all doors.

## 2.12 CITY OF MISSISSAUGA – CORPORATE GREEN BUILDING STANDARDS

### 1. Energy and Climate Change

Fire Hall		
Level 1	Level 2	Level 3
<b>EUI:</b> 105 kWh/m <sup>2</sup> /year <b>TEDI:</b> 75 kWh/m <sup>2</sup> /year <b>GHGI:</b> 11 kgCO <sub>2</sub> e/m <sup>2</sup> /year	<b>EUI:</b> 80 kWh/m <sup>2</sup> /year <b>TEDI:</b> 60 kWh/m <sup>2</sup> /year <b>GHGI:</b> 5 kgCO <sub>2</sub> e/m <sup>2</sup> /year	<b>EUI:</b> 60 kWh/m <sup>2</sup> /year <b>TEDI:</b> 30 kWh/m <sup>2</sup> /year <b>GHGI:</b> 5 kgCO <sub>2</sub> e/m <sup>2</sup> /year

- a. Level 1 – Detailed electrical energy usage calculations shall be performed during detailed design through energy modeling. To achieve the required Level 1 parameters above, the electrical design shall incorporate the use of low energy LED light fixtures and adherence with ASHRAE SB-10 and OBC energy requirements. Standard SB-10 compliant lighting control design is also anticipated to help the overall design in achieving the Level 1 requirements. Provisions to achieve these requirements is anticipated to increase the lighting and load control budget by 25%.
- b. Level 2 – More sophisticated lighting controls are anticipated for helping to achieve Level 2 compliance. This may include day light sensing and lighting control, auto dimming for perimeter lighting and adding occupancy sensor zoning above and beyond SB-10 requirements. Further coordination with mechanical HVAC control systems is anticipated in order to control fan speed and ventilation requirements depending on occupancy. Provisions to achieve these requirements is anticipated to increase the lighting and load control budget by 50%.
- c. Level 3 - This Level requires a reducing in overall energy usage of 45% over and above Level 1. A DALI lighting system may need to be incorporated in order to help achieve these levels. Switching off of non-essential power loads through sensors, timers, occupancy sensors, etc. may also need to be implemented. Integration of all HVAC, plumbing and electrical systems and the provisions of a sophisticated BAS system may also need to be implemented to achieve this rating. Once energy modeling is performed, a more detailed list of deliverables can be provided for achieving Level 3 performance. Provisions to achieve these requirements is anticipated to increase the lighting and load control budget by 100%.

*Please note that on-site renewables may also be required to achieve the parameters above and will be discussed in sections below. The cost provisions in this section do not take into account on-site renewables which have been separately costed (high level) below.*

## 2. Building Commissioning

Monitoring-based Commissioning: Develop monitoring-based procedures and identify points to be measured and evaluated to assess performance of the major energy-consuming systems representing more than 10% of the building's total energy use (at a minimum heating, cooling, lighting, fans, and pumps).

- a. Level 1 – This level of commissioning requires Monitoring-based Commissioning including but not limited to:
- i. Commissioning Plan
  - ii. Commissioning Report
  - iii. Current Facilities Requirements and Operations and Maintenance Plan

Electrical equipment and related systems that will be included in the commissioning plan includes but is not limited to:

- i. Lighting systems
- ii. Lighting control systems
- iii. Power distribution equipment
- iv. Generator
- v. Fire alarm system (as required)
- vi. Door access control
- vii. Security systems

Level 1 commissioning will add a 10% cost to the overall electrical budget compared with a package where no documented commissioning is required.

- b. Level 2 – This level includes all requirements of level 1 with the addition of the following:
- i. System operational manual.

Level 2 commissioning cost increase as it relates to Level 1 will be negligible.

- c. Level 3 – As it relates to electrical systems this level is not applicable.

## 3. On-Site Renewables

On-site energy generation using renewable energy sources is encouraged to reduce GHG emissions associated with building operation, as well as to reduce stresses imposed on the local electricity grid and further improve building resilience in the wake of power outages.

- a. Level 1 – Designed to accommodate future installations of rooftop PV, including but not limited to structural capability to support rooftop PV, space available for future electrical equipment in electrical room, etc. Solar-ready provisions clearly identified in all applicable design documentation, and coordinated between the various design disciplines (electrical, structural, etc.). Provisions of the system will be designed to produce energy equivalent to 5% of the building's annual consumption. The system will be designed such that future PV panels can be installed and connected at a later date. A Net Metering connection is recommended where the PV system shall feed power directly back to the

utility grid offsetting actual consumption of the facility. Anticipated costs for a system such as this (not including structural improvements) is \$3 per watt (of the proposed system) for the electrical infrastructure only.

- b. Level 2 – This level requires actual functional installation of on-site renewable energy devices to offset 5% of building annual energy consumption. All applicable documentation to facilitate the design, installation, operation and maintenance of the renewable energy system (drawings, specifications, maintenance manuals, etc.) shall be produced. Supporting renewable energy analysis calculations to demonstrate that the 5% requirement has been met will be provided. Roof top solar PV is considered the best option for achieving this goal. The cost of this system is anticipated to be \$8 per watt not including structural improvements.
- c. Level 3 – This level requires actual functional installation of on-site renewable energy devices to offset 100% of building annual energy consumption. All applicable documentation to facilitate the design, installation, operation and maintenance of the renewable energy system (drawings, specifications, maintenance manuals, etc.) shall be provided. Supporting renewable energy analysis calculations to demonstrate that net zero energy has been met shall be provided. PV is still the most suitable system for achieving this goal for a fire station. Bio-gas, bio-fuel and wind are not really viable for this type of building. The limiting factor will be area (available suitable roof space). A detailed roof study will be required during detailed design. Average cost per watt for a system of this size will be reduced. The cost of this system is anticipated to be \$5 to \$6 per watt not including structural improvements. However, the overall cost of the system will 10-15 x that of Level 2.

#### 4. Air Tightness

Not applicable to electrical.

#### 5. Metering and Benchmarking

The intent of this measure is to ensure that buildings are provided with an adequate level of metering and measurement systems to facilitate ongoing tracking of energy usage by the building systems.

##### a. Level 1

- i. Metering - Install electricity and / or thermal sub-meters for all energy end-uses that represent more than 10% of the building's total energy consumption. This shall include lighting panels, large HVAC equipment, large gas loads such as hot water tanks, infra-red tube heaters, etc. Provision of electricity and thermal sub-meters shall be clearly indicated on electrical single-line diagrams. A metering plan listing all meters along with type, energy source metered, diagrams, and/or references to design documentation shall be provided.



- ii. Benchmarking - Register the building on ENERGY STAR Portfolio Manager and co-ordinate with the City of Mississauga Energy Management Team to establish the process for ongoing reporting and benchmarking.
- iii. There will be a 5% increase to the overall electrical construction budget to facilitate this provision.

b. Level 2 – Same as Level 1

c. Level 3 – Same as Level 1

#### 6. Resilience Performance Requirements

The intent of this measure is to promote buildings that are designed to maintain critical operations and functions in the face of a shock or stress, and quickly return to normal operations to maintain healthy, livable spaces for its occupants.

- a. Level 1 - Provide 72 hours of back-up power and thermal energy to a central refuge area and to essential building systems as per the City's Minimum Backup Power Guidelines for MURBs. Combustion-based or battery-based systems are both permitted. A narrative describing the project's approach to resilience, with the back-up power source / quantity of fuel to be verified post construction. A natural gas generator providing full back up power to the facility will be installed at this facility. Natural gas has been the preferred fuel source for emergency generators in the GTA post 2003. The generator will be compliant with OBC, ESA, TSSA, NFPA and CSA standards. This will provide the requirements of this provision and the cost addition will be 0% beyond the planned provisions for emergency power.
- b. Level 2 - Only a non-combustion-based system using battery storage or other non-combustion forms of back-up generation is permitted. A battery back-up solution is not feasible for 72 hours of backup for this type of facility. This is due to the amount of storage required. The space and cost of implementing Level 2 is not considered feasible at this time due to limitations of existing battery technology.
- c. Level 3 – Not applicable.

#### 7. Low-impact Materials

Not applicable for electrical.

#### 8. Embodied Carbon Footprint

Not applicable for electrical.

#### 9. Ozone Depleting Compounds

Not applicable for electrical.

## 10. Electric Vehicle Infrastructure

The intent of this measure is to reduce community-wide GHG emissions by promoting electric vehicle use.

- a. Level 1 - Design the building to provide 20% of parking spaces with electric vehicle supply equipment (EVSE) of Level 2 or higher. The remaining parking spaces must be designed to permit future EVSE installation (i.e. EV-ready). Include at least two regular electrical outlets for electric bicycle charging in bike storage area(s).

Vehicle charging requirements place a large demand on the electrical power distribution system. As a result, the power distribution service capacity and all associated equipment including the generator must also be increased.

Level 2 Charging Stations are available anywhere from 3KW to 20KW. The higher the wattage, the faster they charge. As these cars for these stations are anticipated to be charging for over 8 hours, we can specify a lower wattage to reduce the impact on the electrical system. For 3 x 5KW, the increase in service size can be ignored as this is within the safety factor but if the design is expected to provide provisions for future connection for all parking spots, then the service size will have to accommodate for 15+ parking spaces which will require a possible 50% increase in service size and all associated power distribution.

In order to prevent a large increase in service size, it is recommended that future charge ready parking spots be placed on a control system which limits and cycles power from one spot to another when cars are plugged in. The system can be programmed to within the limits of the power system in order not to oversize the incoming power system on day 1 to accommodate future loading. The should be understood that future vehicle charging stations can be added but at that time not all stations will receive 100% charging capacity at all times. This is how most charging parking lots are presently designed.

Costing for each vehicle charging station complete with all associated infrastructure is anticipated to be \$10,000 per station for complete stations and \$2,000 for each future parking spot to make them EV-ready.

- b. Level 2 - Design the building to provide 25% of parking spaces with electric vehicle supply equipment (EVSE) of Level 2 or higher. The remaining parking spaces must be designed to permit future EVSE installation (i.e. EV-ready). Include at least two regular electrical outlets for electric bicycle charging in bike storage area(s).

Similar to Level 1, costing for each vehicle charging station complete with all associated infrastructure is anticipated to be \$10,000 per station for complete stations and \$2,000 for each future parking spot to make them EV-ready.

- c. Level 3 - Design the building to provide 30% of parking spaces with electric vehicle supply equipment (EVSE) of Level 2 or higher. The remaining parking spaces must be designed to permit future EVSE installation (i.e. EV-ready). Include at least two regular electrical outlets for electric bicycle charging in bike storage area(s).

Similar to Level 1, costing for each vehicle charging station complete with all associated infrastructure is anticipated to be \$10,000 per station for complete stations and \$2,000 for each future parking spot to make them EV-ready.

11. Bicycle Infrastructure

Not applicable for electrical.

12. Waste Management Performance Requirements

Not applicable for electrical.

13. Stormwater Management

Not applicable for electrical.

14. Water Use Intensity

Not applicable for electrical.

15. Erosion and Sediment Control

Not applicable for electrical.

16. Light Pollution

The intent of this measure is to reduce the negative impacts that a building's lighting can have while accentuating the benefits.

- a. Level 1 - All exterior fixtures must be Dark Sky compliant, as per the International Dark Sky Association (IDA). Any rooftop and facade architectural illumination must be directed downward and turned off after facility operating hours. Install an automatic device that reduces the outward spillage of internal light by:
- i. Reducing the input power to non-emergency lighting fixtures by at least 50 per cent outside of facility operating hours.
  - ii. Shielding all non-emergency light fixtures outside of facility operating hours.

A lighting list highlighting Dark Sky compliant fixtures shall be provided as part of the lighting schedule. A lighting plan showing boundaries, location of fixtures, and lighting control measures will be provided as part of the photometric analysis during detailed

design. A lighting controls declaration to be provided post construction by the contractor and signed off by the engineer of record.

The costs associated with installation of dark sky compliant fixtures is no more than what is already required by ASHRAE SB-10 requirements and most municipalities.

- b. Level 2 – This level incorporates all requirements outlined in Level 1 as well as the requirement to ensure that any lighting not physically attached to the building is connected to solar PV as a primary source of power. This requirement includes all light poles having an onboard solar charging component. The cost addition for this provision shall be budgeted at \$1,000 to \$1,500 per pole.
- c. Level 3 – Not applicable.

#### 17. Biodiversity

Not applicable for electrical.



appendix E **civil engineering feasibility review**



**Bold Engineering Inc.**  
**2778 Dufferin Street, Suite 104,**  
**Toronto, ON M6B 3R7**  
**Canada**

T: 416-556-0766  
F: 1-866-876-5758

**ENGINEERING FEASIBILITY REVIEW – CIVIL (FINAL)**  
**TEMPLATE DESIGN AND STANDARDS FOR NEW FIRE STATIONS**  
**2 TRUCK STATION – 1 STOREY OPTION**

**Prepared for:**

DPAI Architects  
1800-25 Main Street West, Hamilton, ON  
c/o: The City of Mississauga

Submission Date: October 27, 2020

**Prepared by:**

Bold Engineering Inc.  
2778 Dufferin Street, Suite 104  
Toronto, ON, M6B 3R7



## CONTENTS

1.0	EXECUTIVE SUMMARY.....	3
2.0	CIVIL.....	4
2.1	GENERAL .....	4
2.2	CIVIL AND SITE LANDSCAPING – VEGETATION.....	4
2.3	CIVIL AND SITE LANDSCAPING – STORMWATER MANAGEMENT.....	5
2.4	CIVIL AND SITE LANDSCAPING - HARDSCAPING.....	5
2.5	CIVIL AND SITE LANDSCAPING – BICYCLES AND ELECTRIC VEHICLES .....	6
2.6	CITY OF MISSISSAUGA – CORPORATE GREEN BUILDING STANDARDS.....	7





## 1.0 EXECUTIVE SUMMARY

BOLD Engineering Inc. was retained by the DPAI Architects on behalf of The City of Mississauga to provide an Engineering Feasibility Study in order to aid in the design of proposed layouts for new fire stations proposed by DPAI Architects in order to meet the program requirements of the City of Mississauga Fire Department and associated stake holders. Our review will assess Civil, Mechanical and Electrical systems of the proposed layouts.

Our analysis is based on the program requirements outlined in the Template Design and Standards for New Fire Stations – Program Development Document developed by DPAI dated March 3, 2020. In addition to this document, our analysis will take into consideration, the latest building codes (OBC, ESA, TSSA, ASHRAE, etc.), City of Mississauga accessibility standards and City of Mississauga - Corporate Green Building Standards.

The proposed fire station layout for Option #1 is 2 Trucks, and 10 staff. During shift change, the facility shall accommodate 20 staff. Locker facilities shall accommodate 40 staff. On the “Hot Side” the facility includes laundry and work shop facilities, a bunker room, hose tower and utility spaces including: main electrical room, station storage, hot water room and janitors room. On the “Cold Side” the facility includes two (2) dorm rooms, fitness room, lockers and showers, washroom facilities, accessible (universal) washroom, computer work stations, two (2) captain’s rooms, kitchen and dining rooms, lounge, outdoor areas, IT rooms and janitor’s closet.

Detailed review of the Civil and Site Landscaping Systems are detailed in the sections below.

Prepared by:

BOLD Engineering Inc.

A handwritten signature in black ink that reads "S. Black".

Per:  
Stephen Black, P.Eng.  
Structural Engineer

## **2.0 CIVIL**

### **2.1 GENERAL**

1. This narrative design analysis shall be used in conjunction with the Architect's drawings and plans, and with Mechanical, Electrical and Structural design narratives to develop a complete synopsis of the structural design guidelines for end user stake holder approval for concept design.
2. Final design documents shall be produced and signed by a licensed Professional Civil Engineer licensed for the Province of Ontario, retained by the City of Mississauga.
3. These Preliminary Civil Documents are not intended to reflect the complete requirements for construction documents. The final issued for construction detailed design drawings and specifications shall verify the project civil requirements. The project design and construction of Lot grading, roadway and pavement, storm water management, well system, sewage systems shall be in accordance with current applicable codes, standards and ordinances of the Province of Ontario, particularly the Ontario Building Code (OBC).
4. Unless specifically noted, shop drawings or material data sheets for all civil components identified in the Issued for Construction Drawings shall be produced by the supplier's engineer & approved by the civil engineer of record.
5. The civil engineer of record shall be responsible for determining the design intent of the new Fire Hall. This narrative shall be used only as a basis for design in accordance with the program requirements put forth by DPAI, BOLD Engineering Inc. and the City of Mississauga.

### **2.2 CIVIL AND SITE LANDSCAPING – VEGETATION**

1. Soft landscaping features will include trees, shrubs, plants and vegetation native to the area. The focus will be on the use of resilient indigenous species rather than invasive species or exotic plants that require special care and protection during the winter. All vegetation located in close proximity to the parking lot will be resistant to water with high concentrations of salt and chloride, due to the heavy use of de-icing salts during the winter.
2. The landscaping plan must indicate soil volume, species and quantity for each planting area. It is also to include a comprehensive plant list, provided including both common and scientific names of each plant, and highlighting all pollinator-friendly and native species.

### 2.3 CIVIL AND SITE LANDSCAPING – STORMWATER MANAGEMENT

1. Based on the square footage of the building and the size of the parking lot, a number of precast concrete catch basins will be provided for storm water collection.
2. The surrounding parking lot and any flat roofing must have a minimum slope of 1:50 or 2% to ensure the water can drain.
3. Rainwater will be collected by eaves troughs and downpipe for all sloped roofing. Flat roofs will require either (i) scuppers with heat-tracing and exterior downpipe or (ii) interior roof drains that tie into a storm drainage system. This system is to be designed to reduce stormwater peak flow and runoff volume from the site by promoting the natural hydrological cycle.
4. All soft and hard landscaping should slope away from the foundation wall to direct all storm water run-off away from the building. In order to reduce the build-up of pore water pressure against foundation wall, it is recommended that drainage material, such as gravel or crushed stone, be used as backfill against the side of the building. A perforated drainage pipe or weeping tile located against the side of the strip footing can be also used help reduce pore water pressure. The drainage pipe must be connected to either (i) a sump pit from which water can then be pumped out, or (ii) one of the catch basins.
5. Historic rainfall data for the project location is to be referenced; comprising of data gathered over at least ten years of data and collected from a consistent source. The rainwater management plan will calculate the runoff volume to be managed on site, which depends on post-development site conditions including the amount of paving, permeability of surfaces, roof area, and amount of vegetation. With this information the storm management plan will be designed, utilizing a combination of green infrastructure and low-impact development strategies to replicate the site's natural hydrological cycle and reduce the peak flow and runoff volume
6. During construction an Erosion & Sediment Control plan is to be established to ensure stormwater runoff during this phase does not transport sediment to the existing municipal infrastructure. Catch basin sediment control devices shall be used within the existing site and the adjacent area, in addition to sediment control fence around the perimeter of the site and a mud mat at the construction entrance. These control measures are to notated on the site plan.

### 2.4 CIVIL AND SITE LANDSCAPING - HARDSCAPING

1. All roadways and driveways shall be designed to service heavy duty vehicles including tri-axle salt trucks and fire engines used by the City's operations. This will likely require the use of additional gravel (or Granular A) and Granular B. Each lift must be compacted to at least 98% maximum dry density (Standard Proctor Value). Adequate measures shall be taken to ensure water is not able to pool at the base material below the granular road make-up.

2. The parking lot pavement will likely consist of the following:
  - a. 2” HL3 Wearing Course;
  - b. 2” HL8 Base Course;
  - c. 150mm Gravel or Granular A compacted to 98% Std. Proctor Value; and
  - d. 150mm Granular B compacted to 98% Std. Proctor Value.
3. The driveway area directly in front of and/or behind to the apparatus bay doors is to be composed of a concrete slab apron. This concrete apron shall provide a platform that is more durable than asphalt. This area outside the apparatus bay is needed as an area where fire trucks can be parked without damaging the asphalt driveway (while on standby, for cleaning, maintenance, etc.). This concrete apron will likely consist of the following:
  - a. 200mm Thick Concrete slab – 35 MPA, 5-8% entrained Air with Epoxy coated 15M reinforcement @ 300mm O/C each way – Top & bottom.
  - b. 400mm Granular A compacted 98% Std. Proctor Value
4. The pavement and slab designs outlined above are conceptual only and shall not be included in the final design specifications until OBC, municipal and geotechnical requirements are thoroughly reviewed.
5. The sidewalks will be 5mm thick, Class C1 concrete with 5-8% air entrainment and 6x6-W1.4xW1.4 welded-wire mesh. A basecourse consisting of 6” of Granular A and 6” of Granular B compacted to 98% Std. Proctor is recommended.
6. All roadways and driveways shall be designed to have permeable pavement surfaces. Permeable paving systems consist of porous material that enables stormwater to flow through it or nonporous blocks spaced so that water can flow between the gaps. Permeable paving systems can reduce surface runoff and improve water quality by filtering pollutants in the subsurface layers. Examples of permeable pavement include the following:
  - a. Pervious concrete; and
  - b. Porous asphalt.

## 2.5 CIVIL AND SITE LANDSCAPING – BICYCLES AND ELECTRIC VEHICLES

1. The site design will accommodate electrical vehicle transportation. However, it is imperative that any electrical charging equipment in the parking area will not interfere with fire trucks ability to maneuver in the parking area.
2. The site is to incorporate sufficient infrastructure to support bicycle transportation. The site plan is to have notations indicating location, number, and type of bicycle parking spaces, as well as, notations indicating location and number of shower and change facilities.
3. The bicycle storage area is to include regular electrical outlets to accommodate the charging of electrical bicycles

## 2.6 CITY OF MISSISSAUGA – CORPORATE GREEN BUILDING STANDARDS

### 1. Energy and Climate Change

Not applicable to civil.

### 2. Building Commissioning

Not applicable to civil.

### 3. On-Site Renewables

Not applicable to civil.

### 4. Air Tightness

Not applicable to civil.

### 5. Metering and Benchmarking

Not applicable to civil.

### 6. Resilience Performance Requirements

Not applicable to civil.

### 7. Low-impact Materials

a. Level 1 – Prioritize the use of environmentally preferable building materials, including those that are reused, recycled, and locally-sourced.

i. The steel rebar content must include 50% post-consumer recycled steel. Approximately 93% of structural is recycled and most structural steel contains some post-consumer content; however, a steel mill or steel fabricator should be consulted to confirm that Grade 400 Steel can be produced from a large fraction of post-consumer material.

ii. Replace Ordinary Portland Cement (OPC) with 20% blast furnace slag, silica fume or fly ash. This involves the use of hydraulic cements, which often do not satisfy Class C1 and C2 requirements. This is acceptable for any slabs on grade supporting pedestrian traffic, not heavy equipment of fire trucks.

b. Level 2 – This level includes all requirements of level 1 in addition to the following:

i. The structural steel content must include 75% post-consumer recycled steel. Approximately 93% of structural is recycled. If Grade 400 Steel rebar can be

produced from 75% post-consumer recycled steel, then this is acceptable. Either a steel mill or a steel fabricator should be consulted to ensure this is a viable option

- c. Level 3 – This level includes all requirements of level 2 in addition to the following:
  - i. Refer to International Living Future Institute’s Living Building Challenge.

#### 8. Embodied Carbon Footprint

Not applicable to civil.

#### 9. Ozone Depleting Compounds

Not applicable to civil.

#### 10. Electrical Vehicle Infrastructure

The intent of this measure is to reduce community-wide GHG emissions by promoting electric vehicle use.

- a. Level 1 - Design the building to provide 20% of parking spaces with electric vehicle supply equipment (EVSE) of Level 2 or higher. The remaining parking spaces must be designed to permit future EVSE installation (i.e. EV-ready). Include at least two regular electrical outlets for electric bicycle charging in bike storage area(s).

Vehicle charging requirements place a large demand on the electrical power distribution system. As a result, the power distribution service capacity and all associated equipment including the generator must also be increased.

Level 2 Charging Stations are available anywhere from 3KW to 20KW. The higher the wattage, the faster they charge. As these cars for these stations are anticipated to be charging for over 8 hours, we can specify a lower wattage to reduce the impact on the electrical system. For 3 x 5KW, the increase in service size can be ignored as this is within the safety factor but if the design is expected to provide provisions for future connection for all parking spots, then the service size will have to accommodate for 15+ parking spaces which will require a possible 50% increase in service size and all associated power distribution.

In order to prevent a large increase in service size, it is recommended that future charge ready parking spots be placed on a control system which limits and cycles power from one spot to another when cars are plugged in. The system can be programmed to within the limits of the power system in order not to oversize the incoming power system on day 1 to accommodate future loading. The should be understood that future vehicle charging stations can be added but at that time not all stations will receive 100% charging capacity at all times. This is how most charging parking lots are presently designed.

Costing for each vehicle charging station complete with all associated infrastructure is anticipated to be \$10,000 per station for complete stations and \$2,000 for each future parking spot to make them EV-ready.

- b. Level 2 - Design the building to provide 25% of parking spaces with electric vehicle supply equipment (EVSE) of Level 2 or higher. The remaining parking spaces must be designed to permit future EVSE installation (i.e. EV-ready). Include at least two regular electrical outlets for electric bicycle charging in bike storage area(s).

Similar to Level 1, costing for each vehicle charging station complete with all associated infrastructure is anticipated to be \$10,000 per station for complete stations and \$2,000 for each future parking spot to make them EV-ready.

- c. Level 3 - Design the building to provide 30% of parking spaces with electric vehicle supply equipment (EVSE) of Level 2 or higher. The remaining parking spaces must be designed to permit future EVSE installation (i.e. EV-ready). Include at least two regular electrical outlets for electric bicycle charging in bike storage area(s).

Similar to Level 1, costing for each vehicle charging station complete with all associated infrastructure is anticipated to be \$10,000 per station for complete stations and \$2,000 for each future parking spot to make them EV-ready.

## 11. Bicycle Infrastructure

The site is to incorporate infrastructure to support bicycle transportation.

- a. Level 1 – The site plan is to have notations indicating location, number, and type of bicycle parking spaces, as well as, notations indicating location and number of shower and change facilities.
  - i. Provide short-term bicycle parking for 5% of all peak visitors (1 Space for Visitors).
  - ii. Provide short-term bicycle parking for 10% of all occupants (2 Spaces for Occupants).
  - iii. A minimum of 8 bicycle parking spaces should be provided for the whole building.
- b. Level 2 – This level includes all requirements of level 1 in addition to the following:
  - i. Provide short-term bicycle parking for 7% of all peak visitors.
  - ii. Provide short-term bicycle parking for 15% of all occupants.
  - iii. A minimum of 8 bicycle parking spaces should be provided for the whole building.
  - iv. Additional Cost above Level 1: \$1200

- c. Level 3 – This level includes all requirements of level 1 in addition to the following:
- i. Provide short-term bicycle parking for 7% of all peak visitors.
  - ii. Provide short-term bicycle parking for 15% of all occupants.
  - iii. A minimum of 12 bicycle parking spaces should be provided for the whole building.
  - iv. Provide shower facilities for cyclists.
  - v. Provide public bicycle repair station at-grade with tools including tire levers, screwdrivers and spanners.
  - vi. Additional Cost above Level 2: \$6500

## 12. Waste Management Performance Requirements

Not applicable for civil.

## 13. Stormwater Management

By referencing historic rainfall data for the project location, a storm management plan will be designed, utilizing a combination of green infrastructure and low-impact development strategies to replicate the site's natural hydrological cycle and reduce the peak flow and runoff volume

Provide a stormwater management report, include rainfall data & volume calculations. A stormwater management plan must be prepared along with details, and/or cross-sections consistent with report and including topography, landscaping, grading, etc. After the project is completed, a post construction stormwater runoff declaration must be provided

- a. Level 1 – Provide a stormwater management report, as mentioned above.
- i. The stormwater system must be designed to achieve 85% reduction of the 100-year post-development peak flow to pre-development conditions of the site.
  - ii. The design is to reduce the stormwater runoff volume. The design must retain 80% of the runoff generated from a minimum of 15 mm depth of a single rainfall event from all site surfaces through infiltration, evapotranspiration, water harvesting and reuse.
- b. Level 2 – This level includes all requirements of level 1 in addition to the following:
- i. The stormwater system must be designed to achieve 100% reduction of the 100-year post-development peak flow to pre-development conditions of the site.
  - ii. The design is to reduce the stormwater runoff volume. The design must retain 100% of the runoff generated from a minimum of 15 mm depth of a single rainfall event from all site surfaces through infiltration, evapotranspiration, water harvesting and reuse.
  - iii. Price Increase above Level 1: +25%



- c. Level 3 – This level includes all requirements of level 2 in addition to the following:
  - i. A green roof must be included in the design across all available roof area. Only excluding roof areas which are needed for HVAC equipment, service pathways, and rooftop PV. The superstructure will to be further reinforced to accommodate a green roof.
  - ii. Price Increase above Level 2: +65%

#### 14. Water Use Intensity

Not applicable to civil.

#### 15. Erosion and Sediment Control

During construction an Erosion & Sediment Control plan is to be established to ensure stormwater runoff during this phase does not transport sediment to the existing municipal infrastructure.

- a. Level 1 – Follow the Erosion and Sediment Control Guideline for Urban Construction during construction and demolition activities.
- b. Level 2 – This level includes all requirements of level 1 in addition to the following:
  - i. Remove 80% of total suspended solids (TSS) on an annual loading basis from all runoff leaving the site based on the post-development level of imperviousness.
- c. Level 3 – Not applicable.

#### 16. Light Pollution

Not applicable to civil.

#### 17. Bio-Diversity

- a. Level 1 - The landscaping plan must indicate soil volume, species and quantity for each planting area. It is also to include a comprehensive plant list, provided including both common and scientific names of each plant, and highlighting all pollinator-friendly and native species.
  - i. Provide trees planted in both softscape & hardscape, and ensure these trees have at least the minimum required soil volume. 15 cubic meters of high-quality soil will be provided for small trees, 30 m<sup>3</sup> for medium trees and 45 m<sup>3</sup> for large-sized trees.
  - ii. The site landscaping must include the planting of ‘shade trees’ Approximately 6 - 8 m apart along all street frontages, open space frontages and public walkways.

- 
- iii. The landscaped area should include pollinator-friendly species. At least 10% of all plantings provided must be pollinator-friendly.
  - iv. The use of indigenous plant species is to be prioritized. Ensure that at least 25% of all proposed plantings are native species to the region.
  - v. No invasive plant species are to be used in the landscape design as per Ontario Invasive Plan Council Guidelines.
- b. Level 2 - This level includes all requirements of level 1 in addition to the following:
- i. At least 25% of all plantings provided on site must be pollinator-friendly.
  - ii. Ensure that at least 50% of all plantings proposed on the landscaping plan are native species to the region.
- c. Level 3 - This level includes all requirements of level 1 in addition to the following:
- i. At least 50% of all plantings provided on site must be pollinator-friendly.
  - ii. Ensure that 100% of the plantings proposed on the landscaping plan are native species to the region.

# Appendix 6

Preferred Option I – Site Plan Drawing

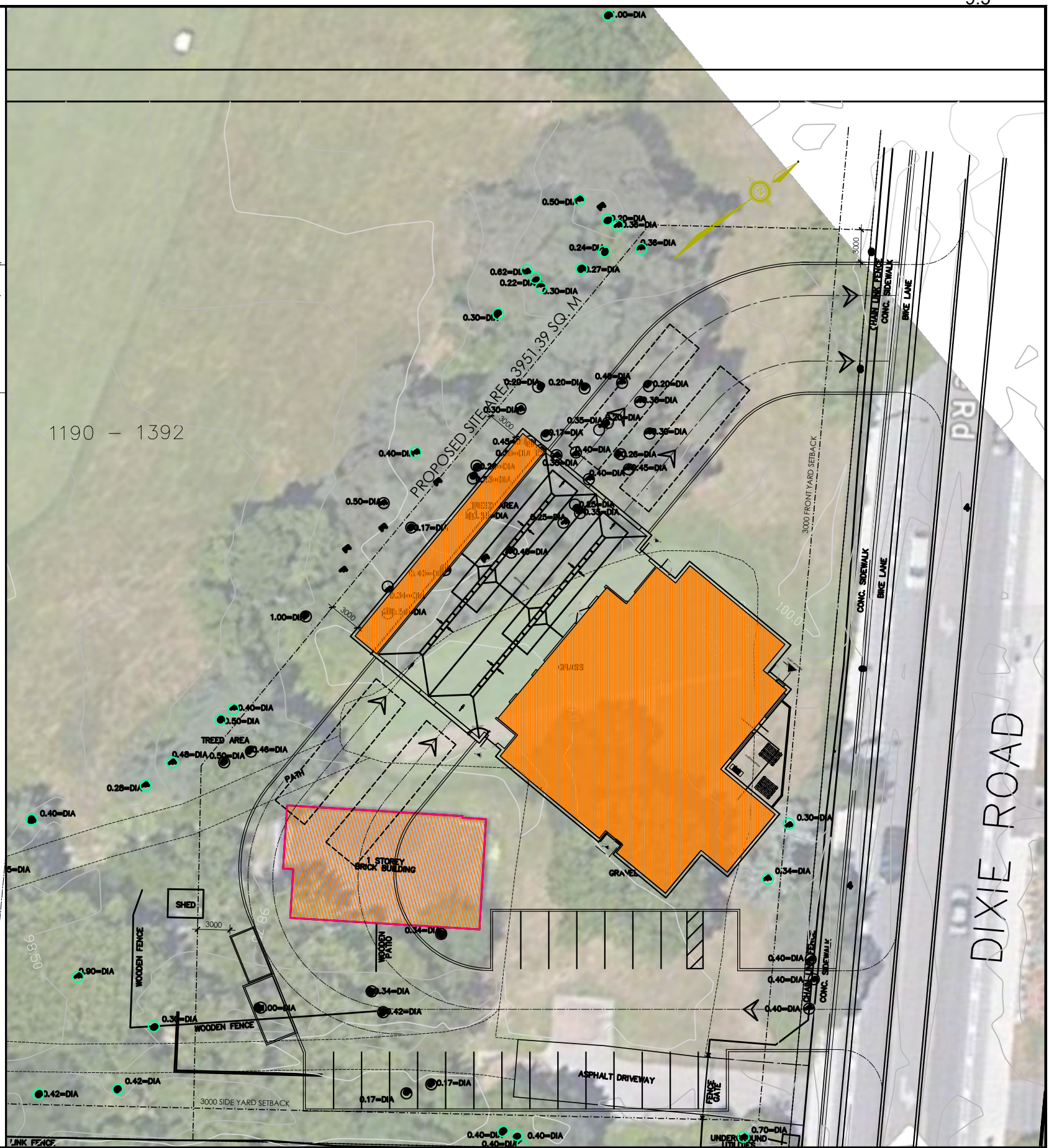
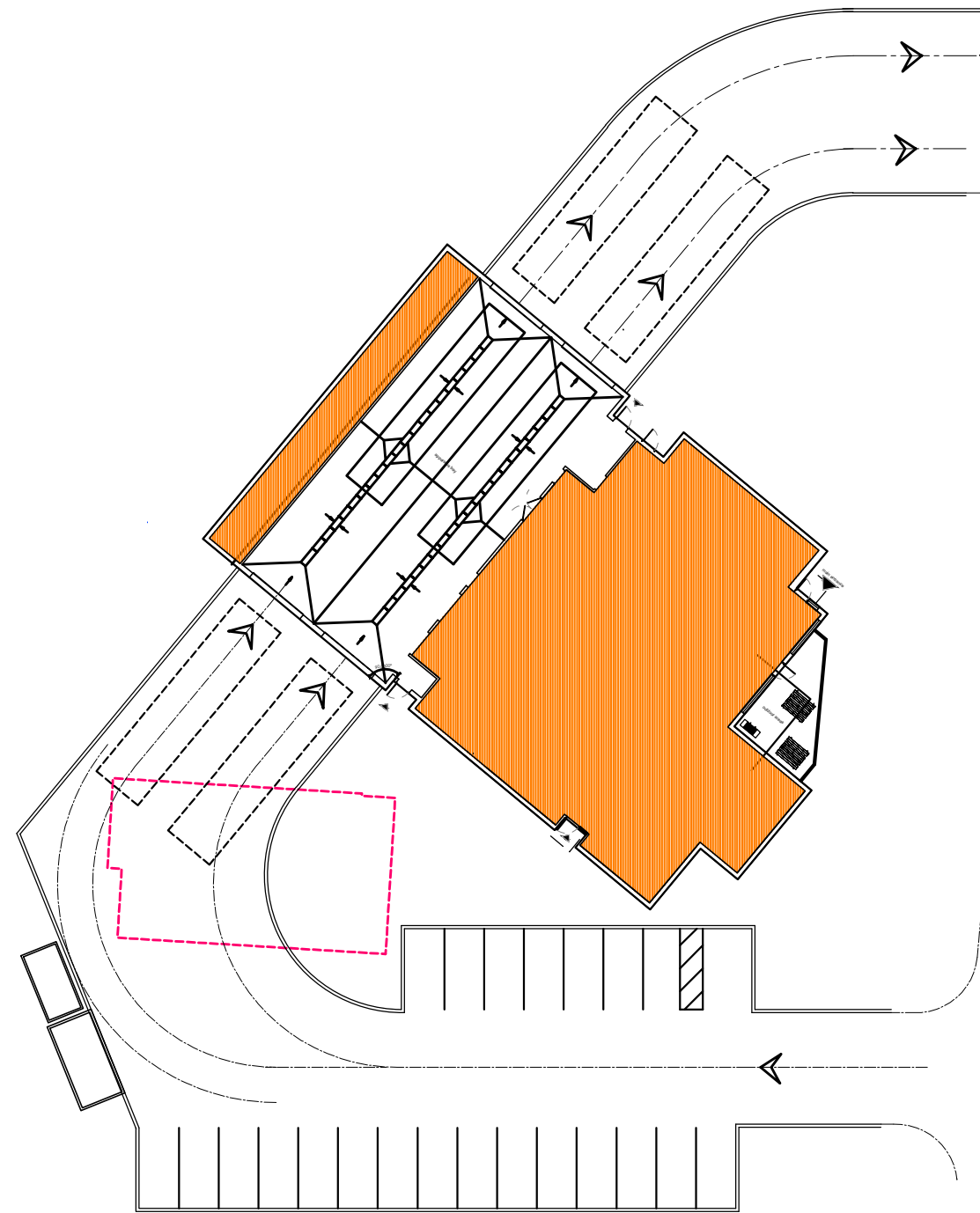

**SITE PLAN**  
**OPTION - 1**  
**SOUTH PARKING &**  
**NORTH EXIT**



**FIRE STATION 128 FEASIBILITY & HIA**  
 LAKEVIEW, MISSISSAUGA, ON.  
 APRIL, 2024

**+TVG ARCHITECTS**  
 THE VENTIN GROUP LTD

## Appendix 7

Shoalts Engineering report: Proposed Relocation of Lakeview Golf Club Cottage Apr26, 2023

### Proposed Relocation of Lakeview Golf Club Cottage



Lakeview Cottage, March 2023

### Terms of Reference

In March 2023, on behalf of Davis Falsarella, Senior Project Manager in Capital Design and Construction for the City of Mississauga, Mutahara Anwar contacted Mark Shoalts of Shoalts Engineering to explore the feasibility of relocating a building on the Lakeview Golf Course. An opinion was sought as an initial step in some planning work for future facilities, with the understanding that it was to be based on visual observation only, with no intrusive or destructive investigation of the structure.

### Executive Summary

Based on our site visit of March 21, 2023 to the former superintendent's residence at the Lakeview Golf Club, we are of the opinion that it is feasible to contemplate moving the building, with certain limitations. Dixie Road is wide enough for moving the building but the railroad to the south and the large number of overhead lines and the QEW to the north effectively limit the usable distance to the length of the golf course itself, and there are no side streets within this section of Dixie so there are no other options. The presence of many overhead utilities along Dixie makes moving the house onto the road a challenging and expensive proposition. Relocation on the golf course property would avoid the cost of temporary utility relocation, but this would be practical for only a short move on relatively flat terrain, which essentially means the corridor between the Fairways Condos and the Dixie Outlet Mall property.

## Building Description

The March 2007 heritage designation report by the City of Mississauga provides information about Lakeview Golf Course in general, and about the former superintendent's residence in particular. As stated in the report, there are several structures on the property including a new clubhouse and a cart shed at the south end of the parking lot, a maintenance facility at the north end of the parking lot, and the superintendent's residence, at 1392 Dixie Road, at the northeast corner of the property. [The dwelling faces onto Dixie Road and is accessed by its own driveway. An inconspicuous laneway from Dixie provides access to the course. The superintendent's residence was built in 1914 for the course's golf pro, Alfred Russell. It is an Edwardian style bungalow. A large simplified roof dominates the simple structure. A tall chimney and a Classical pediment disrupt the roof line. Short colonettes and brick piers support the extended eaves. A pattern of three raised vertical lines, the middle one longer than the outer two, enhance the street face of each colonette. They anchor a generous veranda, enclosed by balustrades, accessed by six steps. Sidelights enhance the entryway. Bay windows flank it. Additional fenestration exists on the other faces. Horizontal siding currently sheathes the structure.](#)<sup>1</sup>

What is not stated in the report and is not immediately obvious because of the horizontal siding noted in the last line of the description is that the building is a solid brick structure, currently clad with vinyl siding. No photographs have been found showing the building without the vinyl siding, and no indication has been given as to why the building was covered with siding.

An unusual feature of the dwelling is the existence of brick foundation walls. The building is approximately 30' wide by 44' long and it was constructed of load-bearing two-wythe brick walls, with a full basement in the rear two-thirds of the building and a crawlspace in the front third. The floors, partitions, and roof are of conventional wood framing, and the interior of the brick walls on the main floor are covered with wood lath and plaster. The brick walls in the basement and crawlspace are exposed for the most part, although there are areas of cement parging. There are three interior bearing walls of brick masonry in the basement. The stairs to the basement are on the rear of the house, essentially appended to the back of the kitchen and a brick wall separates the stairs from both the kitchen and the basement. Another wall divides the basement in half across the building, and the third wall separates the basement from the crawlspace under the front third of the house. Two bay windows on the front of the house do not have foundations under them, being carried on cantilevered floor joists, and the front porch is of wood frame carried on the front wall of the house and on four brick piers. The interior bearing brick walls, which carry the floor joists, do not extend up through the house. All of the partitions are of wood frame. The floors are of Douglas fir T&G, laid directly on the joists.

The front porch has been rebuilt relatively recently. A 2007 photograph shows the brick piers covered with paint, but they are not presently painted, and they have been relaid with reclaimed brick. The original stone caps are in place. The porch floor and steps leading up to it are built of pressure-treated lumber.

---

<sup>1</sup> 2007 Heritage Designation Report, Mark Warrack, City of Mississauga

### Building Condition

Brick is typically viewed as a long-lasting, high-quality finish for building walls. Vinyl siding is a modern “maintenance-free” finish that is not high quality, not long-lasting, and not maintenance free, and would not ordinarily be installed over brick. A logical inference for its presence would be that there was extensive or problematic deterioration of the brick exterior and the vinyl siding was installed either as a cosmetic gesture or to improve the weatherability of the building, or both. Without the removal of the siding this cannot be confirmed, but the small glimpses of the brick available through service penetrations of the vinyl, broken sections, and through loose joints that can be pried open showed the brick to be in relatively good condition. Because only very small, localized areas could be seen, there is the distinct possibility that the overall condition may not meet this expectation. If the siding is to be removed and the brick restored, at the very least there will be a large number of holes to repair from the fasteners holding the wood strapping to the brick. If the fasteners were driven into the mortar joints, which is typical, the work is a large repointing job, which would be expensive but is usually straightforward. If the fasteners were driven into the bricks, the damage may be so extensive that restoration is impractical. This would be the case whether the building is moved or is retained in situ.

Foundation walls are ordinarily of stone, concrete masonry, or poured concrete. Brick masonry does not typically stand up well to the high moisture levels and extremes of freeze-thaw cycles that foundation walls experience, particularly right at grade, but the exposed brick of the Lakeview cottage foundation is in relatively good condition. There are deteriorated mortar joints as would be expected, but the masonry units themselves are good for the most part.

The wood-framed floors and roof appear to be in good condition, with the exception of the asphalt shingles themselves on the roof which require replacement. The windows appear to be the original single-glazed wood single-hung units for the most part, with aluminum exterior storm windows over them. They are in acceptable condition. An enclosed rear porch and deck are extensions of and modifications to an original porch and are of inferior quality and condition.

The condition of the interior of the house varies from fairly well-preserved original finishes in some areas to poor alterations and lower-quality finishes in other areas, but generally the house is intact and could easily be restored to its original condition.

### Proposed Relocation

Lifting and moving buildings with load-bearing masonry walls is a specialized business with a limited number of practitioners in Southern Ontario. The buildings are heavy and fragile, and the exercise is fraught with peril if not undertaken properly. Very few heritage masonry buildings have any type of reinforcing, which means the masonry can collapse catastrophically if subjected to the wrong stresses or vibrations. That said, buildings such as this can be moved successfully, and this building is a good candidate. It is essentially rectangular, with only a couple of anomalies that require special consideration.



The front porch has already been rebuilt; we would recommend shoring the roof back to the building and removing the piers and floor structure, to be rebuilt again in the new location. The rear porch is within the footprint of the basic rectangle and can be moved with the building, although it would require rebuilding to return it to its original form. The rear projecting stairway could and should be lifted with the whole building. There is a high chimney on one side of the building that is currently covered with vinyl siding. If exploration reveals that the masonry is poor, it would be prudent to dismantle it and rebuild it after the move rather than risk it collapsing during the move.

The foundation is quite high, providing good access for the system of steel beams that would be required to lift the house. Beams would have to be inserted through the foundation across the building on each side of each brick wall, and beams below these would be run lengthwise. Steel angles would be required on the beams to carry all of the masonry.

Depending upon the time of year and the proposed final location, extensive planking may be required to provide the necessary support for the moving wheels. This is only practical on firm, level ground, which places strict limits on where the building could move if kept intact. Assuming that the complete building is moved, it would have to be placed in its final location where it would be cribbed, then the basement would be excavated and a poured concrete foundation constructed. It would be more difficult to move the building onto a foundation that was constructed before the relocation. It would make more sense for strength, durability, and economy to place the house on a concrete foundation with steel columns and beams replacing the interior brick bearing walls rather than to lay a new brick basement. The house would be lowered into place after the basement is built. The exterior of the exposed foundation should be faced with salvaged brick to maintain the appearance of a brick foundation, and the porches would be rebuilt.

If it is imperative to move the Lakeview Cottage beyond the area defined by the constraints discussed in this report, there is the possibility of dismantling and rebuilding it. While this would typically be more expensive than moving a complete building, there are considerations with Lakeview Cottage that may make this a viable option. The extent of masonry restoration required is unknown and cannot be determined without removing the vinyl siding. A major masonry restoration project could be as expensive as laying new walls with salvaged brick, and there would be the opportunity to rebuild the cottage as a wood framed structure with brick veneer. This would require a fraction of the brick, and it is possible that there could be only enough good brick to do this. A wood frame structure would provide the opportunity for upgrading insulation and wiring, and would present the same finished appearance as the house has now. Cutting the walls into sections and moving them as masonry panels is another option, but that is typically more expensive than moving the whole building and if there are significant problems with the brick, it may not be a reasonable course of action. Once again, removal of the vinyl siding is required to be able to determine if this is feasible.

## Conclusions

The former superintendent's cottage at Lakeview Golf Course is an important heritage attribute of this designated property. It was built specifically for the course soon after it opened, and it represents a significant part of the course's story. While the immediate area around the house has changed significantly since it was built, and further changes may be in the works, the dwelling is an intact part of the course fabric and should be retained to maintain its significance.

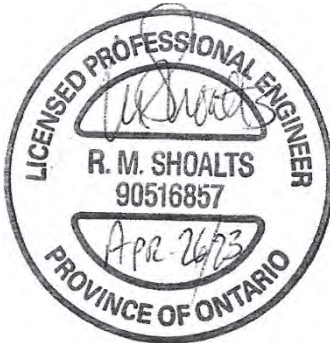

Mark Shoalts, P.Eng., CAHP  
Shoalts Engineering  
April 26, 2023

## Appendix 8

Alternate Site Options 4a, 4b, 5A and 5b

### Mitigation Options 4a and 4b

Options 4a and 4b are variations of the plan arrangement provided in FS 124. Mississauga provided the design layout of Fire Station 124 as an optional template design standard during the development of this HIA to see if it could provide a better functional fit to the site with less heritage impact (see Section 2.3.4.5).

The street presence of the building is considered better in Options 4a and 4b compared with Option 1, however, Option 1 is the most successful operationally.

Both Option 4a and 4b utilize the two-storey apparatus support spaces adjacent to the truck bays. This is an integral part of the design for Fire Station 124 that reduces the width of the building. A reduced building width has the potential to improve the negative impact on the trees lining the rough of the adjacent fairway.

### Option 4a



*Option 4a layout. This option contemplates full demolition of the greenskeeper's house to allow for the construction of the entry driveway and parking area. Surveyed tree locations and trunk caliper were examined to understand the impact on existing trees. Note that tree trunks circled in green would be retained.*

A generator enclosure and a waste and recycling enclosure is required accessible from the paved area on the entry side of the traffic flow. This is currently shown in the plan diagram above, directly ahead when entering the site. The enclosures would need to be slightly larger than what is shown in the diagram. This could be accomplished by moving the building farther north.

The exit driveway needs to accommodate both trucks abreast. This would push the exit driveway farther north than what is shown, having a greater impact on hole 13.

Option 4a is considered significantly operationally less viable than Option 1. The visibility of oncoming traffic at the exit driveway is partially obstructed by the footprint of the building as the driver approaches the street. This is an issue both for the driver of the fire truck as well as for drivers of oncoming vehicles on Dixie Road. Additionally, the requirement to make a ninety degree turn just prior to entering the road effectively means that that the truck would need to come to a complete stop to check the traffic in both directions, slowing response time.

All four of the largest trees identified in Section 2.3 (specimens with trunk diameters of 0.9m, 1.0m, 1.0m and 1.2m) would be able to be retained in this option. There is however a significant impact in this option to trees towards the north end of the site where the construction of the exit driveway would result in the loss of all the trees in that area. The trees at the north end of the site are more visible from the area in front of the tee of hole 13, as can be seen in Image 2.4.5.

## Option 4b

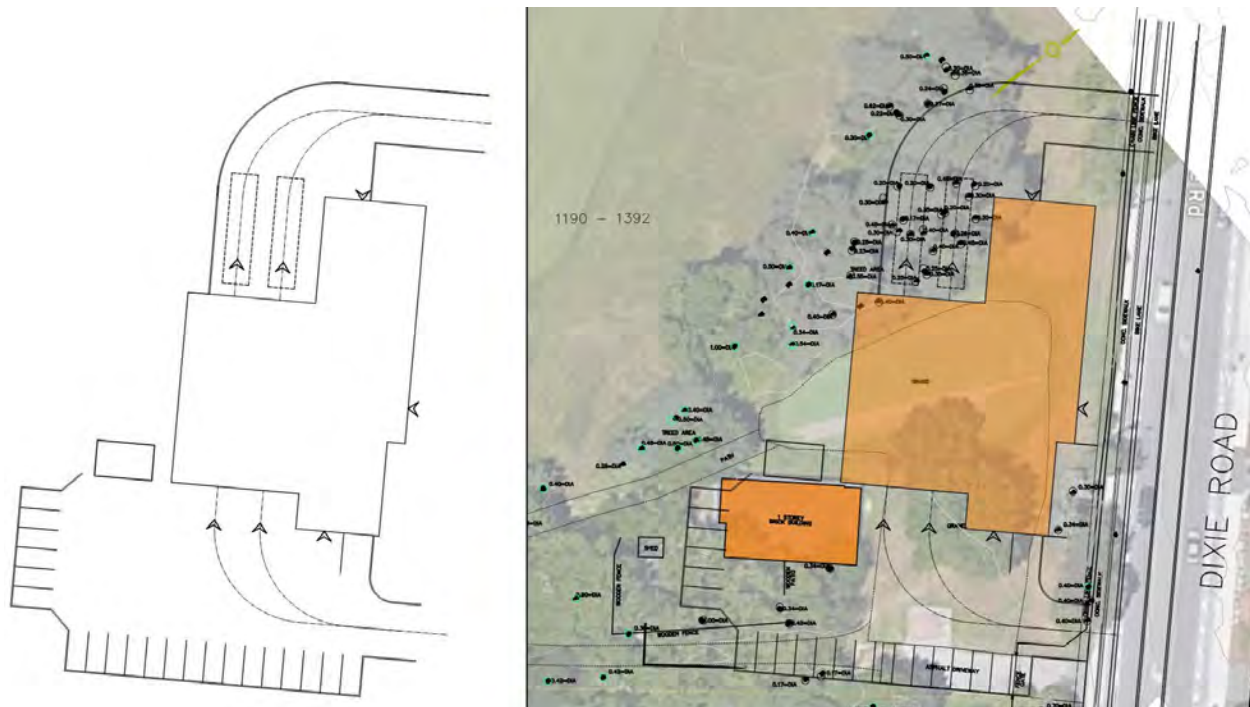

*Image 2.6.4: Option 4b layout. This option contemplates full demolition of the greenskeeper's house to allow for the construction of the entry driveway and parking area. Surveyed tree locations and trunk caliper were examined to understand the impact on existing trees. Note that tree trunks circled in green would be retained.*

The option 4b entry drive lacks the space needed for the fire engines to straighten before entering the garage (apparatus bay). The vehicles should not be still turning while crossing the threshold of the vehicle bay. The aerial vehicle cannot enter the vehicle bay on a radius. Improvement of this option would require moving the building northward to the point where vehicle movement is not a problem. This would have a greater negative impact on the trees adjacent to the exit driveway. Input from the Fire Department would be required to determine the amount of straight run that is needed.

The exit driveway needs to accommodate both trucks abreast. This would push the exit driveway farther north than what is shown, having a greater impact on hole 13.

Like Option 4a, Option 4b is considered significantly operationally less viable than Option 1. The visibility of oncoming traffic at the exit driveway is partially obstructed by the footprint of the building as the driver approaches the street. This is an issue both for the driver of the fire truck as well as for drivers of oncoming vehicles on Dixie Road. Additionally, the requirement to make a ninety degree turn just prior to entering the road effectively means that that the truck would need to come to a complete stop to check the traffic in both directions, slowing response time.

Three of the largest four trees identified in Section 2.3 (specimens with trunk diameters of 0.9m, 1.0m, 1.0m and 1.2m) would be able to be retained in this option. There is however a significant impact in this option to trees towards the north end of the site where the construction of the exit driveway would result in the loss of all the trees in that area.

This option also has a negative heritage impact on trees along the fairway, and proposes the full removal of the existing greenskeeper's house building.

## Mitigation Options 5a and 5b

Options 5a and 5b are variations of the plan arrangement provided in FS 124. Mississauga provided the design layout of Fire Station 124 as an optional template design standard during the development of this HIA to see if could provide a better functional fit to the site with less heritage impact.

The street presence of the building is considered better in Options 5a and 5b compared with Option 1, however, Option 1 is the most successful operationally.

Both Option 5a and 5b utilize the two-storey apparatus support spaces adjacent to the truck bays. This is an integral part of the design for Fire Station 124 that reduces the width of the building. A reduced building width has the potential to improve the negative impact on the trees lining the rough of the adjacent fairway.

## Option 5a



*Option 5a layout. This option contemplates retention of the greenskeeper's house. Surveyed tree locations and trunk caliper were examined to understand the impact on existing trees. Note that tree trunks circled in green would be retained.*

The exit driveway needs to accommodate both trucks abreast. This would push the building and the entrance driveway farther north than what is shown, having a greater impact on hole 13.

Option 5b is considered significantly operationally less viable than Option 1. The visibility of oncoming traffic at the exit driveway is partially obstructed by the footprint of the building as the driver approaches the street. This is an issue both for the driver of the fire truck as well as for drivers of oncoming vehicles on Dixie Road. Additionally, the requirement to make a ninety degree turn just prior to entering the road effectively means that that the truck would need to come to a complete stop to check the traffic in both directions, slowing response time.

All four of the largest trees identified in Section 2.3 (specimens with trunk diameters of 0.9m, 1.0m, 1.0m and 1.2m) would be able to be retained in this option. There is however a significant impact in this option to trees towards the north end of the site where the construction of the entrance driveway and parking would result in the loss of all the trees in that area.

## Option 5b



*Option 5b layout. This option contemplates retention of the greenskeeper's house. Surveyed tree locations and trunk caliper were examined to understand the impact on existing trees. Note that tree trunks circled in green would be retained.*

The exit driveway needs to accommodate both trucks abreast. This would push the building and the entrance driveway farther north than what is shown, having a greater impact on hole 13.

Option 5b is considered significantly operationally less viable than Option 1. The visibility of oncoming traffic at the exit driveway is partially obstructed by the footprint of the building as the driver approaches the street. This is an issue both for the driver of the fire truck as well as for drivers of oncoming vehicles on Dixie Road. Additionally, the requirement to make a ninety degree turn just prior to entering the road effectively means that that the truck would need to come to a complete stop to check the traffic in both directions, slowing response time.

All four of the largest trees identified in Section 2.3 (specimens with trunk diameters of 0.9m, 1.0m, 1.0m and 1.2m) would be able to be retained in this option. There is however a significant impact in



this option to trees towards the north end of the site where the construction of the entrance driveway and parking would result in the loss of all the trees in that area.

# Appendix 9

Chain of Title Report, Parcel Register, and Property Index Map

## CHAIN OF TITLE REPORT

Project #: 24050300812  
 Address: 1190 Dixie Road, Mississauga  
 Legal Part Lot 6 & 7 Con 2 SDS TT  
 Description: as in TT190553, EX Part 1, 43R13134

Searched at: Brampton  
 LRO #: 43

Page 1

PIN #: 13480-0225(LT)

INSTR #	DOC. TYPE	REG. DATE	PARTY FROM	PARTY TO
	Patent ( Lot 6 - 200 Acres)	11 11 1843	Crown	James BUCHANAN
37674	Deed	06 08 1850	James Buchanan	Edward BURNS
41801	Deed	29 09 1851	Edward Burns	Robert CAMPBELL
919	Mortgage	29 08 1854	Robert Campbell	James SPURR (Mortgagee)
8519	Deed (Power of Sale)	01 11 1860	James Spurr (Robert Campbell defaulted in Mtg)	Robert Alexander HARRISON
9084	Deed	11 04 1861	Robert Alexander Harrison	John GRIFFITH
675	Deed	06 12 1870	James (John) Griffith	Alex GRIFFITH
1379	Deed	13 03 1874	Alex Griffith	Charles WOOD
1505	Deed	16 10 1874	Charles Wood	Daniel DEATH

Cont'd on Page 2

## CHAIN OF TITLE REPORT

Project #: 24050300812  
 Address: 1190 Dixie Road, Mississauga  
 Legal Part Lot 6 & 7 Con2 SDS TT  
 Description: as in TT190553, EX Part 1, 43R13134

Searched at: Brampton  
 LRO #: 43

Page 2

PIN #: 13480-0225(LT)

INSTR #	DOC. TYPE	REG. DATE	PARTY FROM	PARTY TO
1569	Deed	13 01 1875	Charles Wood	William SMITH
2033	Deed	13 11 1876	William Smith	Reuben DUNN
8256	Deed	16 09 1893	Daniel Death	Frederick Alex DEATH
12671	Deed (97.5 Acres)	02 05 1907	Reuben Dunn	High Park Golf & Country Club of Toronto Ltd.
13871	Deed	19 03 1910	Frederick Alex Death	Richard A. DONALD
14354	Deed	15 03 1911	Richard A. Donald	Robert EWING
14399	Deed (41.35 Acres)	01 04 1911	Robert Ewing	High Park Golf & Country Club of Toronto Ltd.
14578	Deed	25 07 1911	High Park Golf & Country Club of Toronto Ltd.	Lakeview Golf & Country Club
TT190553	Deed (Present Owner)	16 12 1965	Lakeview Golf & Country Club	The Corporation of The City of Mississauga

Cont'd on Page 3

## CHAIN OF TITLE REPORT

Project #: 24050300812  
 Address: 1190 Dixie Road, Mississauga  
 Legal: Part Lot 6 & 7 Con 2 SDS TT  
 Description: as in TT190553, EX Part 1, 43R13134

Searched at: Brampton  
 LRO #: 43

Page 3

PIN #: 13480-0225(LT)

INSTR #	DOC. TYPE	REG. DATE	PARTY FROM	PARTY TO
VS254472	Easement	30 03 1973	The Corporation of The City of Mississauga	HMQ: Minister of The Environment
PR1775148	By-Law	08 02 2010	To Designate The Lakeview Golf Course as Being of Cultural Heritage Value or Interest	
PR4110472	Easement	02 09 2022	The Corporation of The City of Mississauga	Alectra Utilities Corporation

## CHAIN OF TITLE REPORT

Project # #24050300812  
 Address: 1190 Dixie Road, Mississauga  
 Legal Part Lots 6 & 7 Con 2 SDS TT  
 Description: as in TT190553, Ex Part 1, 43R13134

Searched at: Brampton  
 LRO #: 43 Page 1

PIN# 13480-0225 (LT)

INSTR #	DOC. TYPE	REG. DATE	PARTY FROM	PARTY TO
	Patent ( Lot 7 - 200 Acres)	06 01 1810	Crown	James GLENNON
391	Deed	08 02 1810	James Glennon	Oliver GRACE
4318	Deed	14 11 1822	Oliver Grace - Estate	Robert MEIGHAN
8097	Deed	18 07 1831	Robert Meighan	Robert W. PRENTICE
10700	Deed	28 04 1834	Robert W. Prentice	William B. JARVIS
16376	Deed	13 07 1839	William B. Jarvis	Michael CRAWFORD
49041	Deed	28 04 1853	Michael Crawford	James ROBINSON
8183	Deed	15 05 1893	James Robinson	Peter ROBINSON
18908	Deed	05 04 1919	Peter Robinson	Peter B. TRUMPOUR

Cont'd on Page 2

## CHAIN OF TITLE REPORT

Project # #24050300812  
 Address: 1190 Dixie Road, Mississauga  
 Legal Part Lots 6 & 7 Con 2 SDS TT  
 Description: as in TT190553, Ex Part 1, 43R13134

Searched at: Brampton  
 LRO #: 43 Page 2

PIN# 13480-0225 (LT)

INSTR #	DOC. TYPE	REG. DATE	PARTY FROM	PARTY TO
21024	Deed	09 06 1921	Peter B. Trumpour	Albert HAMILTON
24740	Deed	20 05 1924	Peter B. Trumpour	Samuel SHERRATT
32036	Deed	06 09 1929	Samuel Sherratt	Miriam BARKER
34538	Deed	16 04 1932	Albert Hamilton	William LANDLESS
35855	Deed	10 03 1934	William Landless	Lakeview Golf Club Ltd.
41863	Deed	24 06 1942	Miriam Barker	Jozef & Mary GLISTA
50348	Deed	16 07 1947	Jozef & Mary Glista	Andrew SOBALA & Eva
89340	Deed	08 07 1955	Andrew Sobala & Eva Sobala	Mary H. PURTLE
91751	Deed	28 10 1955	Mary H. Purtle	Lakeview Golf Club Ltd.

Cont'd on Page 3

## CHAIN OF TITLE REPORT

Project # #24050300812  
 Address: 1190 Dixie Road, Mississauga  
 Legal Part Lots 6 & 7 Con 2 SDS TT  
 Description: as in TT190553, Ex Part 1, 43R13134

Searched at: Brampton  
 LRO #: 43 Page 3

PIN# 13480-0225 (LT)

INSTR #	DOC. TYPE	REG. DATE	PARTY FROM	PARTY TO
TT190553	Deed <b>(Present Owner)</b>	16 12 1965	Lakeview Golf Club Ltd.	<b>The Corporation of the City of Mississauga</b>
VS254472	Easement	30 03 1973	The Corporation of the City of Mississauga	HMQ: Minister of The Environment
PR1775148	By-Law	08 02 2010	To Designate the Lakeview Golf Course as Being of Cultural Heritage Value or Interest	
PR4110472	Easement	02 09 2022	The Corporation of the City of Mississauga	Alectra Utilites Corporation



LAND  
REGISTRY  
OFFICE #43

13480-0225 (LT)

PAGE 1 OF 2  
PREPARED FOR bertucci  
ON 2024/05/16 AT 19:13:14

\* CERTIFIED IN ACCORDANCE WITH THE LAND TITLES ACT \* SUBJECT TO RESERVATIONS IN CROWN GRANT \*

PROPERTY DESCRIPTION: PT LTS 6 & 7, CON 2 , SDS TT AS IN TT190553 EXCEPT PT 1 43R13134 ; S/T VS254472; SUBJECT TO AN EASEMENT IN GROSS OVER PART 1, 43R40223 AS IN PR4110472; CITY OF MISSISSAUGA

PROPERTY REMARKS:

ESTATE/QUALIFIER:

FEE SIMPLE  
LT CONVERSION QUALIFIED

RECENTLY:

RE-ENTRY FROM 13480-0446

PIN CREATION DATE:

1998/01/23

OWNERS' NAMES

THE CORPORATION OF THE CITY OF MISSISSAUGA

CAPACITY SHARE

BENO

REG. NUM.	DATE	INSTRUMENT TYPE	AMOUNT	PARTIES FROM	PARTIES TO	CERT/CHKD
<p><b>**EFFECTIVE 2000/07/29</b> THE NOTATION OF THE "BLOCK IMPLEMENTATION DATE" OF 1997/03/18 ON THIS PIN**</p> <p><b>**WAS REPLACED WITH THE "PIN CREATION DATE" OF 1998/01/23**</b></p> <p><b>** PRINTOUT INCLUDES ALL DOCUMENT TYPES AND DELETED INSTRUMENTS SINCE 1998/01/23 **</b></p> <p><b>**SUBJECT, ON FIRST REGISTRATION UNDER THE LAND TITLES ACT, TO:</b></p> <p><b>** SUBSECTION 44(1) OF THE LAND TITLES ACT, EXCEPT PARAGRAPH 11, PARAGRAPH 14, PROVINCIAL SUCCESSION DUTIES * AND ESCHEATS OR FORFEITURE TO THE CROWN. * * * * *</b></p> <p><b>** THE RIGHTS OF ANY PERSON WHO WOULD, BUT FOR THE LAND TITLES ACT, BE ENTITLED TO THE LAND OR ANY PART OF IT THROUGH LENGTH OF ADVERSE POSSESSION, PRESCRIPTION, MISDESCRIPTION OR BOUNDARIES SETTLED BY CONVENTION. * * * * *</b></p> <p><b>** ANY LEASE TO WHICH THE SUBSECTION 70(2) OF THE REGISTRY ACT APPLIES. * * * * *</b></p> <p><b>**DATE OF CONVERSION TO LAND TITLES: 1998/01/26 **</b></p>						
TT190553	1965/12/16	TRANSFER	\$1,100,000		THE CORPORATION OF THE TOWNSHIP OF TORONTO	C
TT190553Z	1965/12/16	REST COV APL ANNEX				C
43R356	1971/05/12	PLAN REFERENCE				C
43R605	1972/07/31	PLAN REFERENCE				C
VS254472	1973/03/30	TRANSFER EASEMENT	\$2		H.M. THE QUEEN (ONTARIO) REPRESENTED BY THE MINISTER OF THE ENVIROMENT	C
LT1854487	1998/08/04	ORDER		THE ONTARIO CLEAN WATER AGENCY	THE REGIONAL MUNICIPALITY OF PEEL	C
CORRECTIONS: 'THIS INSTRUMENT' WAS DELETED FROM PROPERTY 13297-0565 IN ERROR AND WAS RE-INSTATED ON 2003/02/05 BY DANIELA PARKER.						
PR1775148	2010/02/08	BYLAW		THE CORPORATION OF THE CITY OF MISSISSAUGA		C

NOTE: ADJOINING PROPERTIES SHOULD BE INVESTIGATED TO ASCERTAIN DESCRIPTIVE INCONSISTENCIES, IF ANY, WITH DESCRIPTION REPRESENTED FOR THIS PROPERTY.

NOTE: ENSURE THAT YOUR PRINTOUT STATES THE TOTAL NUMBER OF PAGES AND THAT YOU HAVE PICKED THEM ALL UP.

LAND  
REGISTRY  
OFFICE #43

13480-0225 (LT)

PAGE 2 OF 2  
PREPARED FOR bertucci  
ON 2024/05/16 AT 19:13:14

\* CERTIFIED IN ACCORDANCE WITH THE LAND TITLES ACT \* SUBJECT TO RESERVATIONS IN CROWN GRANT \*

REG. NUM.	DATE	INSTRUMENT TYPE	AMOUNT	PARTIES FROM	PARTIES TO	CERT/ CHKD
<i>REMARKS: TO DESIGNATE THE LAKEVIEW GOLF COURSE AS BEING OF CULTURAL HERITAGE VALUE OR INTEREST</i>						
PR3878176	2021/07/27	APL DEPOSIT PLAN		*** COMPLETELY DELETED ***		
43R40002	2021/07/28	PLAN REFERENCE <i>REMARKS: PR3878176.</i>				C
43R40223	2022/02/02	PLAN REFERENCE				C
PR4110472	2022/09/02	TRANSFER EASEMENT	\$38,000	THE CORPORATION OF THE CITY OF MISSISSAUGA	ALECTRA UTILITIES CORPORATION	C

NOTE: ADJOINING PROPERTIES SHOULD BE INVESTIGATED TO ASCERTAIN DESCRIPTIVE INCONSISTENCIES, IF ANY, WITH DESCRIPTION REPRESENTED FOR THIS PROPERTY.  
NOTE: ENSURE THAT YOUR PRINTOUT STATES THE TOTAL NUMBER OF PAGES AND THAT YOU HAVE PICKED THEM ALL UP.

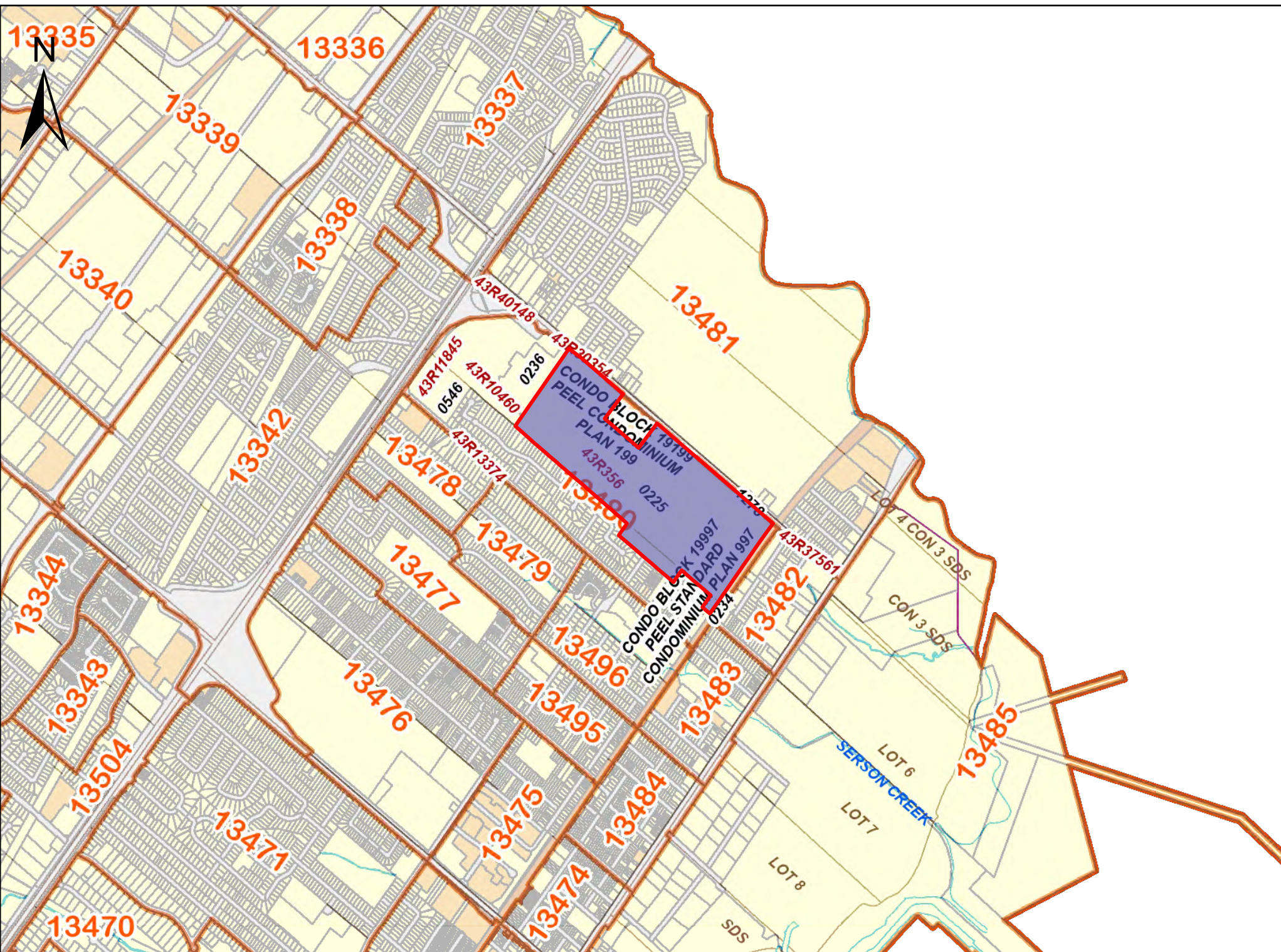

PRINTED ON 17 MAY, 2024 AT 09:29:16  
FOR BERTUCCI

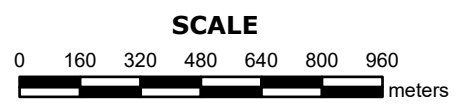

**PROPERTY INDEX MAP**  
PEEL(No. 43)

**LEGEND**

FREEHOLD PROPERTY	
LEASEHOLD PROPERTY	
LIMITED INTEREST PROPERTY	
CONDOMINIUM PROPERTY	
RETIRED PIN (MAP UPDATE PENDING)	
PROPERTY NUMBER	0449
BLOCK NUMBER	08050
GEOGRAPHIC FABRIC	
EASEMENT	

**THIS IS NOT A PLAN OF SURVEY**

**NOTES**

**REVIEW THE TITLE RECORDS FOR COMPLETE PROPERTY INFORMATION AS THIS MAP MAY NOT REFLECT RECENT REGISTRATIONS**

THIS MAP WAS COMPILED FROM PLANS AND DOCUMENTS RECORDED IN THE LAND REGISTRATION SYSTEM AND HAS BEEN PREPARED FOR PROPERTY INDEXING PURPOSES ONLY

FOR DIMENSIONS OF PROPERTIES BOUNDARIES SEE RECORDED PLANS AND DOCUMENTS

ONLY MAJOR EASEMENTS ARE SHOWN

REFERENCE PLANS UNDERLYING MORE RECENT REFERENCE PLANS ARE NOT ILLUSTRATED

